

# Large and Small (Far and Near) Liquid Argon Detectors for Accelerator-Based Neutrino Physics

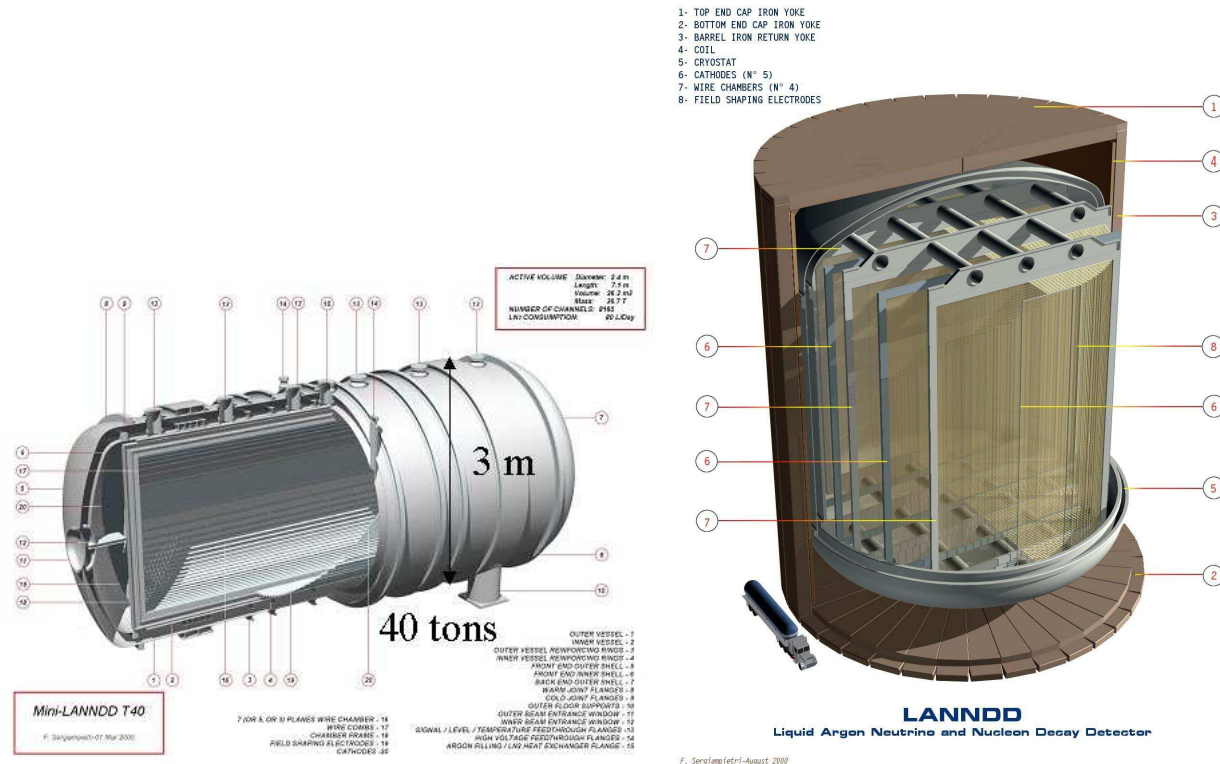

**Kirk T. McDonald**  
*Princeton U.*

[kirkmcd@princeton.edu](mailto:kirkmcd@princeton.edu), <http://puhep1.princeton.edu/~mcdonald/nufact/>

*Workshop on Neutrino Super Beam, Detector, and Proton Decay*

**Brookhaven National Laboratory, March 5, 2004**

# Can Study CP Violation at $L/E = (2n + 1)500 \text{ km/GeV}$

[Marciano, hep-ph/0108181, Diwan *et al.*, hep-ph/0303081]

The  $n$ th maximum of  $\nu_2$ - $\nu_3$  oscillations occurs at  $L/E \approx (2n + 1)400 \text{ km/GeV}$ .

The CP asymmetry grows with distance:

$$A = \frac{P(\nu_\mu \rightarrow \nu_e) - P(\bar{\nu}_\mu \rightarrow \bar{\nu}_e)}{P(\nu_\mu \rightarrow \nu_e) + P(\bar{\nu}_\mu \rightarrow \bar{\nu}_e)} \approx \frac{2s_{12}c_{12}c_{23}\sin\delta}{s_{23}s_{13}} \left( \frac{\Delta m_{12}^2}{\Delta m_{23}^2} \right) \frac{\Delta m_{23}^2 L}{4E_\nu}$$

$$\Rightarrow \frac{\delta A}{A} \approx \frac{1}{A\sqrt{N}} \propto \frac{E_\nu}{L\sqrt{N}} \approx \text{independent of } L \text{ at fixed } E_\nu.$$

$N_{\text{events}} \propto 1/L^2$ ,

$\Rightarrow$  Hard to make other measurements at large  $L$ .

Low  $E_\nu$  favorable for CP violation measurements.

If (still) need to disentangle matter effects from CP asymmetries, use the  $n = 0$  and 1 oscillation maxima with  $E_1$  as low as possible,

Ex: FNAL-Kenosha (986 km),

BNL-FNAL (1286 km).

Oscillation Nodes for  $\Delta m^2 = 0.0025^2 \text{ eV}$

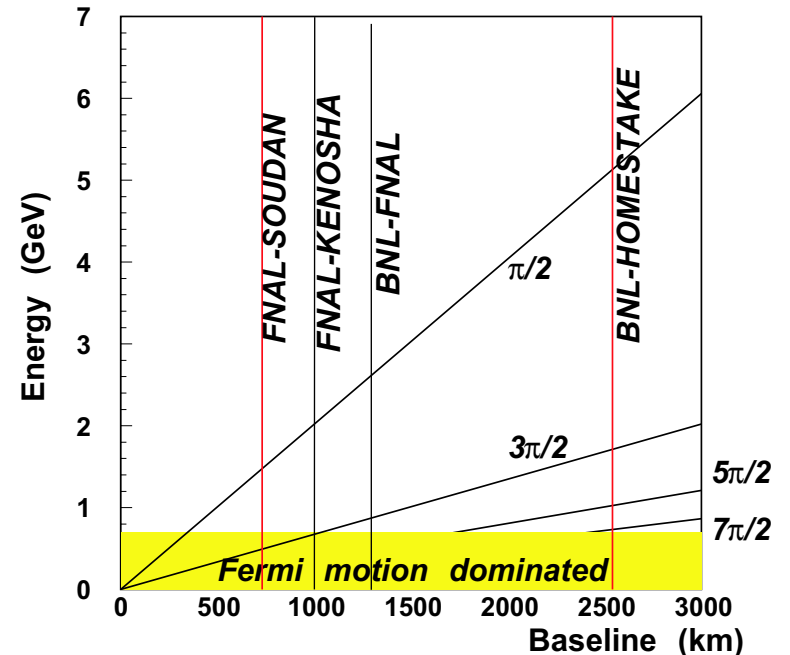

# Narrowband Beam via Solenoid Focusing

(physics/0312022)

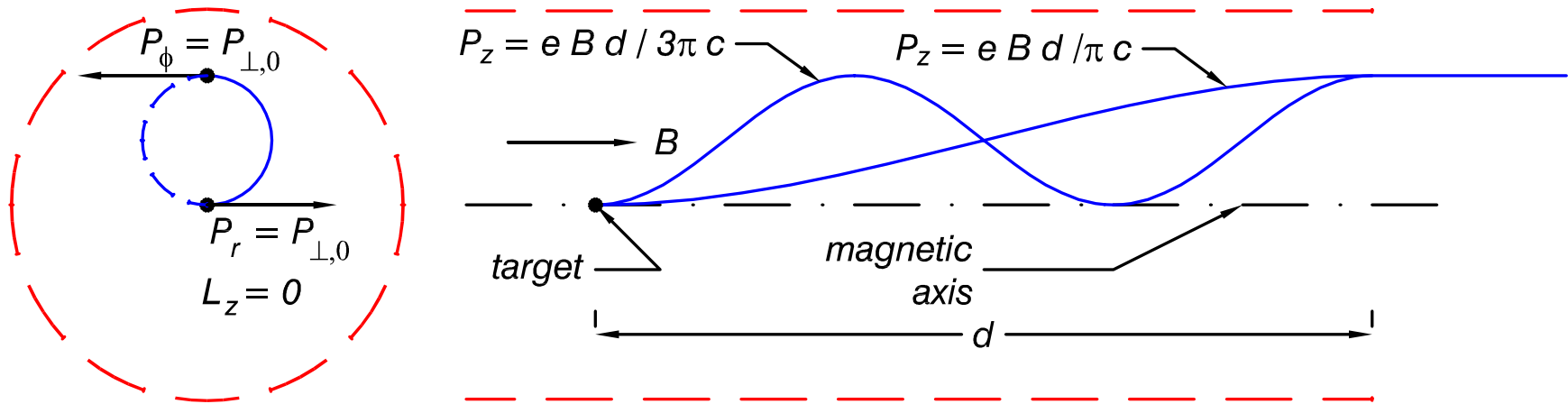

- Point-to-parallel focusing occurs for  $P_\pi = e B d / (2n + 1) \pi c$ .
- $\Rightarrow$  Narrowband neutrino beam with multiple peaks at

$$E_\nu \approx \frac{4}{9} \frac{e B d}{(2n + 1) 2 \pi c}$$

- $\Rightarrow$  Can study several neutrino oscillation peaks at once, at

$$\frac{1.27 M_{23}^2 [\text{eV}^2] L [\text{km}]}{E_\nu [\text{GeV}]} = \frac{(2n + 1) \pi}{2}$$

- Get both  $\nu$  and  $\bar{\nu}$  at the same time (while  $\nu_e$  and  $\bar{\nu}_e$  suppressed),
  - $\Rightarrow$  Must use detector that can identify sign of  $\mu$  and  $e$ ,
  - $\Rightarrow$  Magnetized liquid argon TPC.

# Liquid Argon TPC Overview

- A liquid argon time-projection chamber is a total-absorption tracking calorimeter = An electronic bubble chamber.
- It's efficiency for detection of  $\nu_e$  appearance events will be greater than 90% for GeV energies.  
(This is  $\gtrsim 3$  times the efficiency of low- $Z$  sampling detectors.)
- A large ( $> 10$  kton) liquid argon TPC, if in a single cryostat, will cost very nearly the same as a low- $Z$  sampling detector of the same mass.  
(There is highly competitive industry support for production, purification and storage of large quantities of liquid argon.  
Liquid scintillator costs 2.5 times as much as liquid argon, per unit mass.)
- The hardware of a liquid argon TPC is in a mature state, and readily scalable to large masses.
- More in need of further development is the software – in the style of bubble chambers.  
(Human scanning of event displays if necessary.)

# ICARUS Liquid Argon TPC

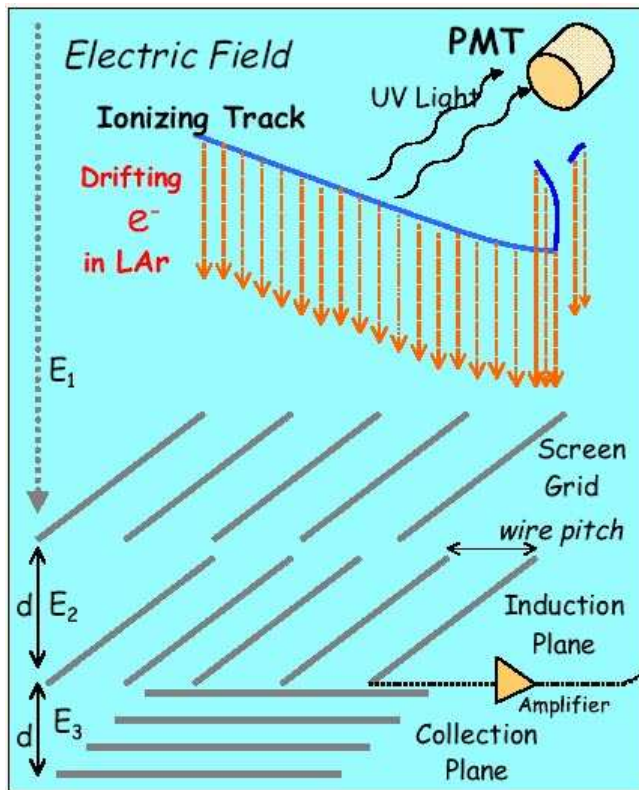

## ICARUS Liquid Argon TPC

The LAr TPC technique is based on the fact that ionization electrons can drift over large distances (meters) in a volume of purified liquid Argon under a strong electric field. If a proper readout system is realized (i.e. a set of fine pitch wire grids) it is possible to realize a massive "electronic bubble chamber", with superb 3-D imaging.

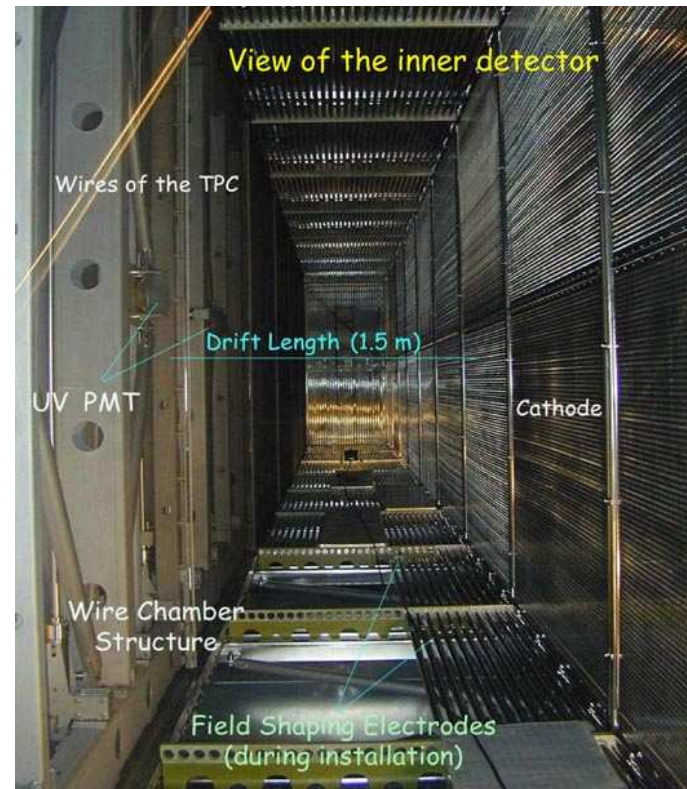
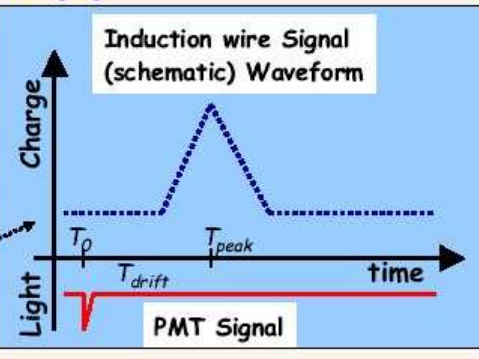

Liquid argon time projection chamber conceived by C. Rubbia (1977).

Largest implementation to date is the ICARUS T600 (600 ton) module, on the surface in Pavia, Italy.

<http://www.aquila.infn.it/icarus/>



# Events from the ICARUS T300 Cosmic Ray Test

Induction I

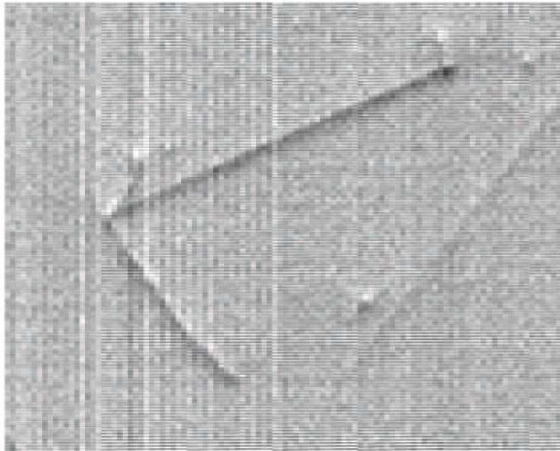

Induction II

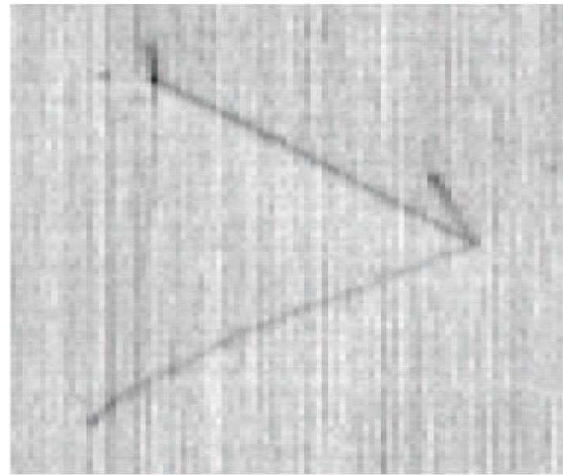

Collection



Above: 3 views of a low-energy hadronic interaction.

Right: Computer reconstruction.

Far right: Cosmic ray shower that includes a muon with a  $\delta$ -ray, a stopping muon, and an electromagnetic shower.

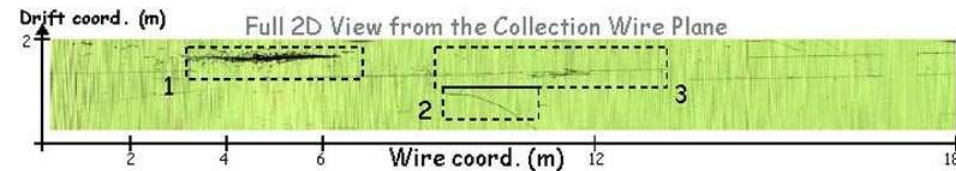
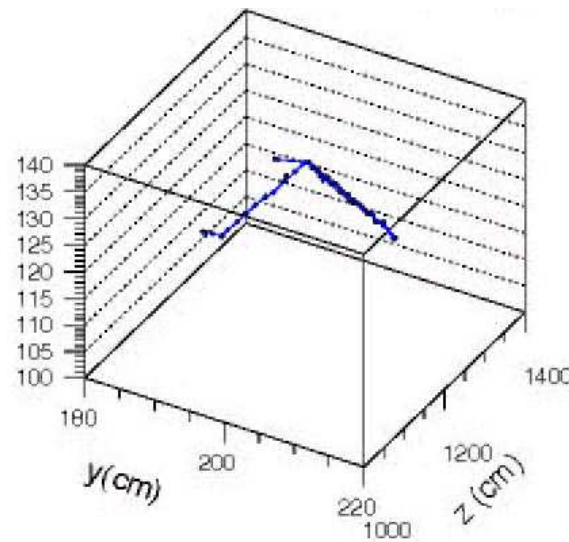

Zoom details

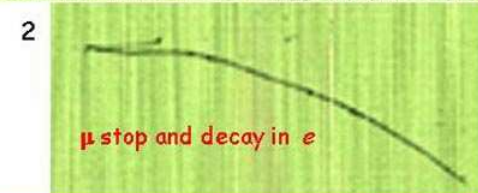
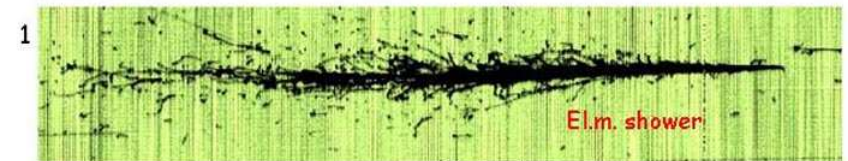

# Liquid Argon TPC Properties

- **3D tracking + total-absorption calorimetry.**
- **Pixel size: 3 mm × 3 mm (wire planes) × 0.6 mm (via 400 ns time sampling).**
- **$\rho = 1.4 \text{ g/cm}^3$ ,  $T = 89\text{K}$  at 1 atm.,  $X_0 = 14 \text{ cm}$ ,  $\lambda_{\text{int}} = 80 \text{ cm}$ .**
- **A minimum ionizing particle yields 50,000  $e/\text{cm}$ .**
- **Drift velocity of 1.5 m/msec at 500 V/cm  $\Rightarrow$  5 m drift in 3 msec.**
- **Diffusion coef.  $D = 6 \text{ cm}^2/\text{s} \Rightarrow \sigma = 1.3 \text{ mm}$  after 3 msec.**
- **Can have only 0.1 ppb of  $\text{O}_2$  for a 5 m drift,  
 $\Rightarrow$  Purify with Oxisorb.**
- **Liquid argon costs \$0.7M/kton – and is “stored” not “used”.**

- Large modules ( $\gtrsim 100$  kton) can be built using technology of liquid methane storage. (Total cost of a 100-kton detector is estimated to be \$200M.)



- Detector is continuously “live” and can be “self-triggered” using pipelined, zero-suppression electronics.
- Operates at the Earth’s surface with near zero overlap of cosmic ray events.
- Detector is compatible with operation in a magnetic field.



## Liquid Argon is the Best Detector to Study $\sin^2 2\theta_{13}$

- $\approx 10$  times better per kton than water Čerenkov for  $\nu_\mu \rightarrow \nu_e$  appearance at 1-2 GeV (Harris).

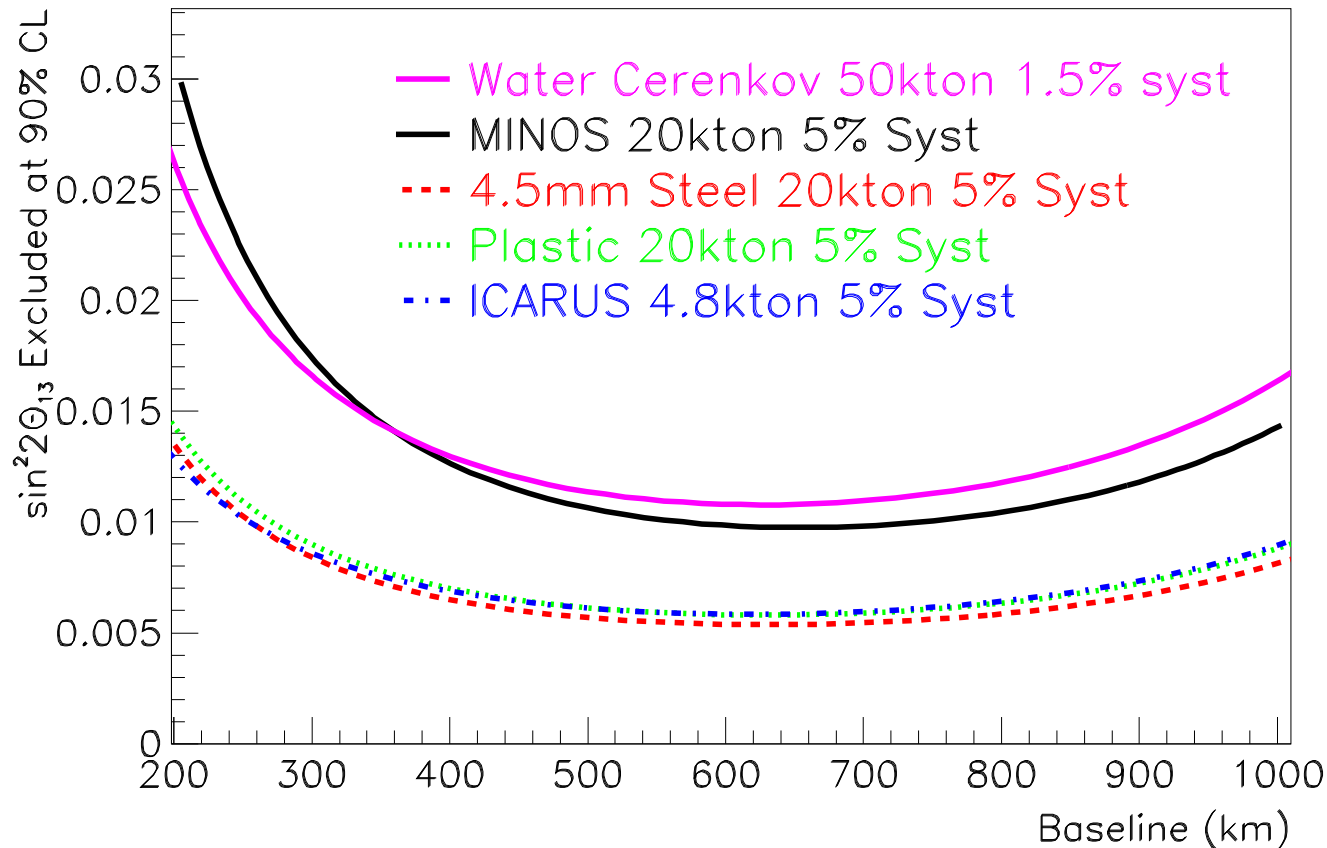

- 100% sampling tracking and calorimetry.
- Construction is simplest of large neutrino detector options.
- Best rejection of neutral current backgrounds, including soft  $\pi^0$ 's.

# LANNDD – 100 kton Liquid Argon Neutrino and Nucleon Decay Detector

(astro-ph/0105442, Nucl. Instr. and Meth. A503, 136 (2003))

- 1- TOP END CAP IRON YOKE
- 2- BOTTOM END CAP IRON YOKE
- 3- BARREL IRON RETURN YOKE
- 4- COIL
- 5- CRYOSTAT
- 6- CATHODES (N° 5)
- 7- WIRE CHAMBERS (N° 4)
- 8- FIELD SHAPING ELECTRODES

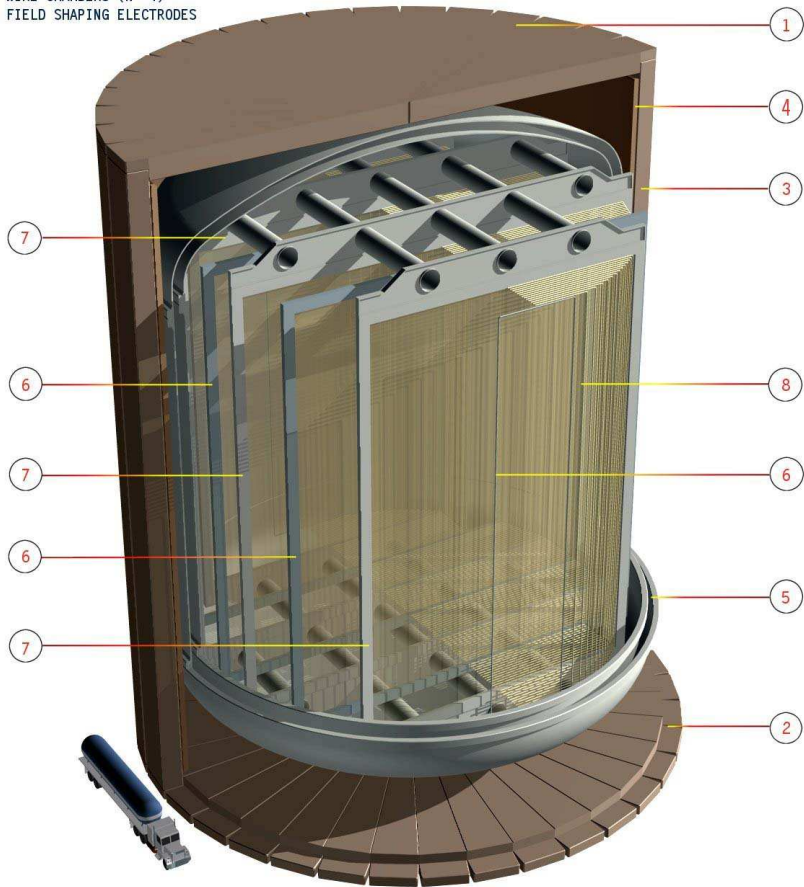

**LANNDD**

Liquid Argon Neutrino and Nucleon Decay Detector

F. Sergiampietri-August 2000

N° OF WIRE CHAMBERS	4
WIRE CHAMBER CH1, CH4	W=26.46m H=40m
CH2, CH3	W=38.73m H=40m
READOUT PLANES/CHAMBER	4 [2 at +45°, 2 at -45°]
SCREEN-GRID PLANES/CHAMBER	3
N° OF WIRES-CHANNELS/PLANE	CH1, CH4 8x15'664=125'312
CH2, CH3	8x18'557=148'455
TOTAL N° OF WIRES-CHANNELS	273'767

ACTIVE VOLUME	48'000 m <sup>3</sup>
ACTIVE MASS	67 kT
N° OF CATHODE PLANES	5
MAXIMUM DRIFT	5 m
MAXIMUM HIGH VOLTAGE	250 kV
REQUIRED PURITY LIFETIME	15+20 ms

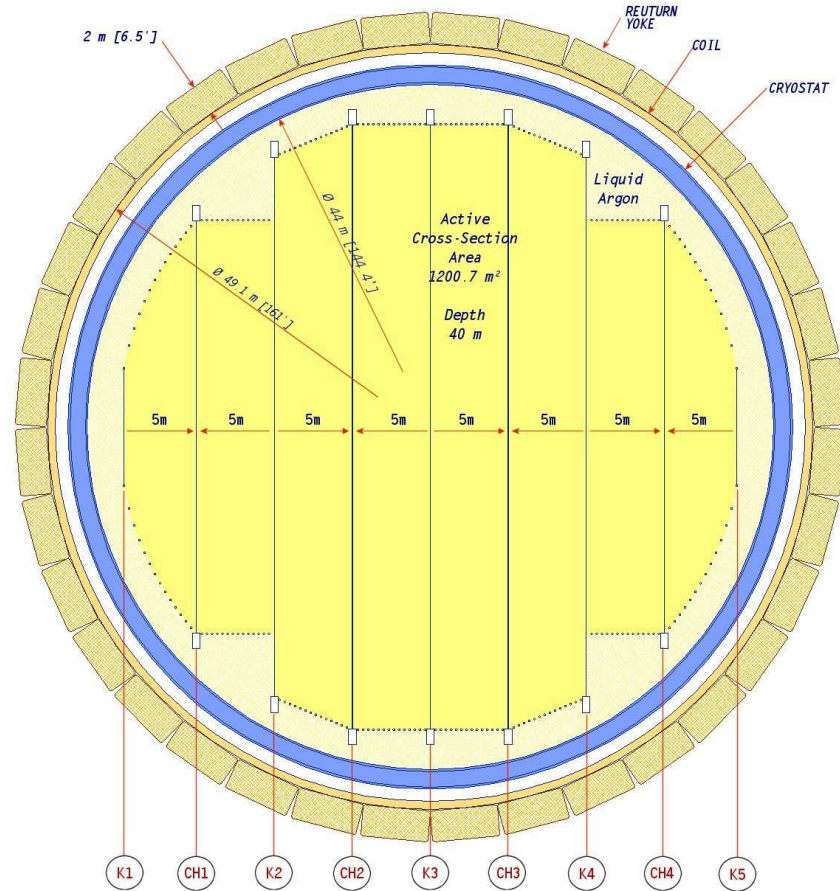

**LANNDD**

Liquid Argon Neutrino and Nucleon Decay Detector  
Horizontal Cross-Section

F. Sergiampietri-August 2000

Max drift length of 5 m (limited by O<sub>2</sub> purity), ⇒ Several drift cells.

# Liquid Argon Detector Issues

(per April 2003 ANL Workshop)

## 1. Basic design.

Unchanged in years.

Based on to concept of a liquid argon detector (Alvarez) in the form of a time-projection chamber (Nygren), which combination was suggested by C. Rubbia.

## 2. Construction details and issues.

Extensive industry support for large cryogenic storage tanks, and for argon purification systems.

## 3. Building and infrastructure.

A cryogenic storage tank is a steel building, designed for operation in extreme climates worldwide.

A “counting house” for people, computers and cryogenic diagnostic equipment would be required ( $\approx 5000 \text{ ft}^2$ ).

## 4. Need for an overburden and/or active veto.

Doubtful, in view of excellent granularity of the detector.

Compare cosmic-ray tests on the surface in Pavia, Italy.

5. Cost, including building, infrastructure and operational expenses.

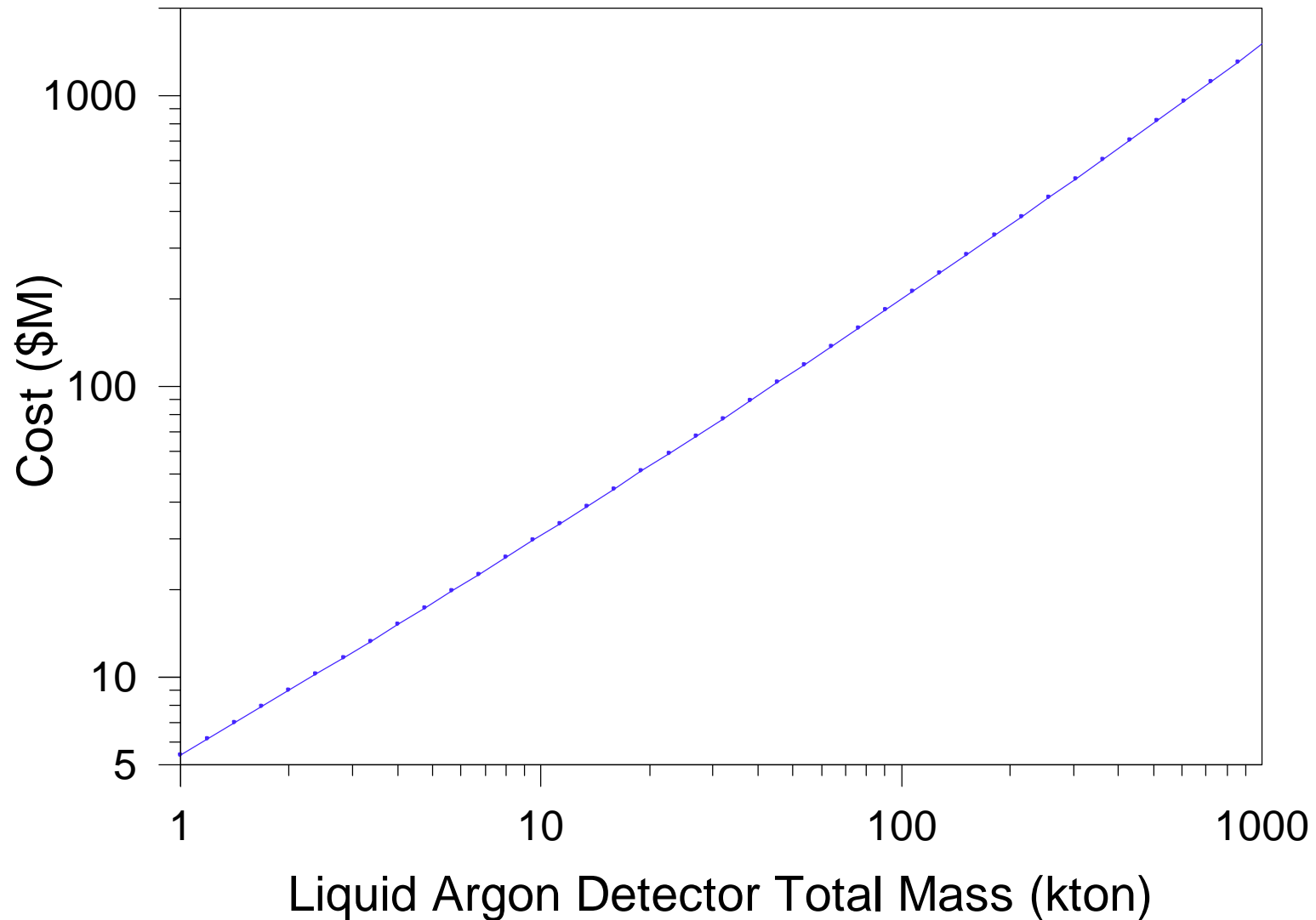

**Preliminary cost estimate given on p. 19.**

**\$112M for a 50 kton detector (incl. 30% contingency).**

**Refrigeration (100 kW @ 90K, 0.5 MW wall power) is the main operating expense.**



## 6. What fraction of the detector is fiducial?

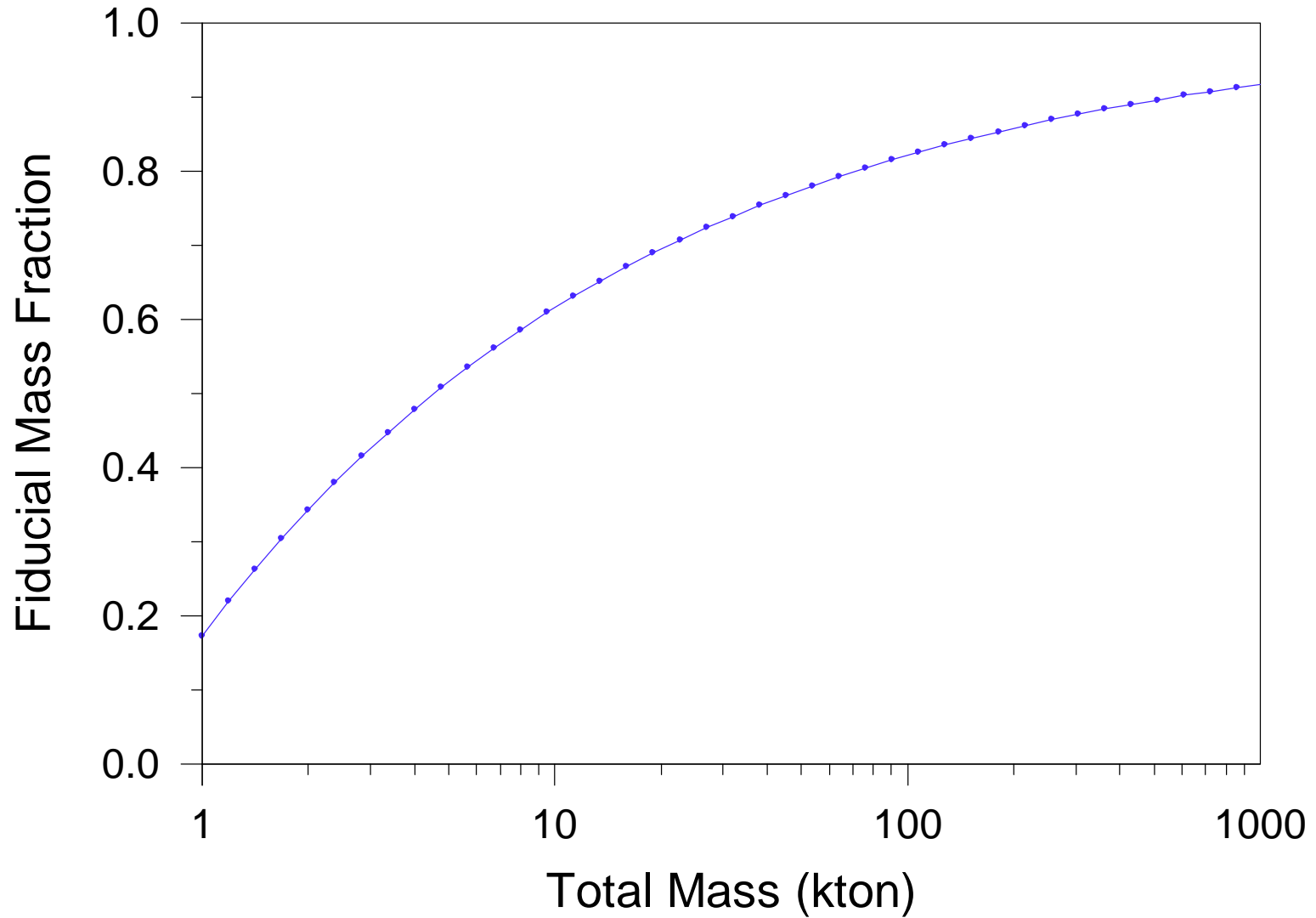

**78% @ 50kton, IF build a single module.**

## 7. Modularity.

Most cost effective to build a single, large module.

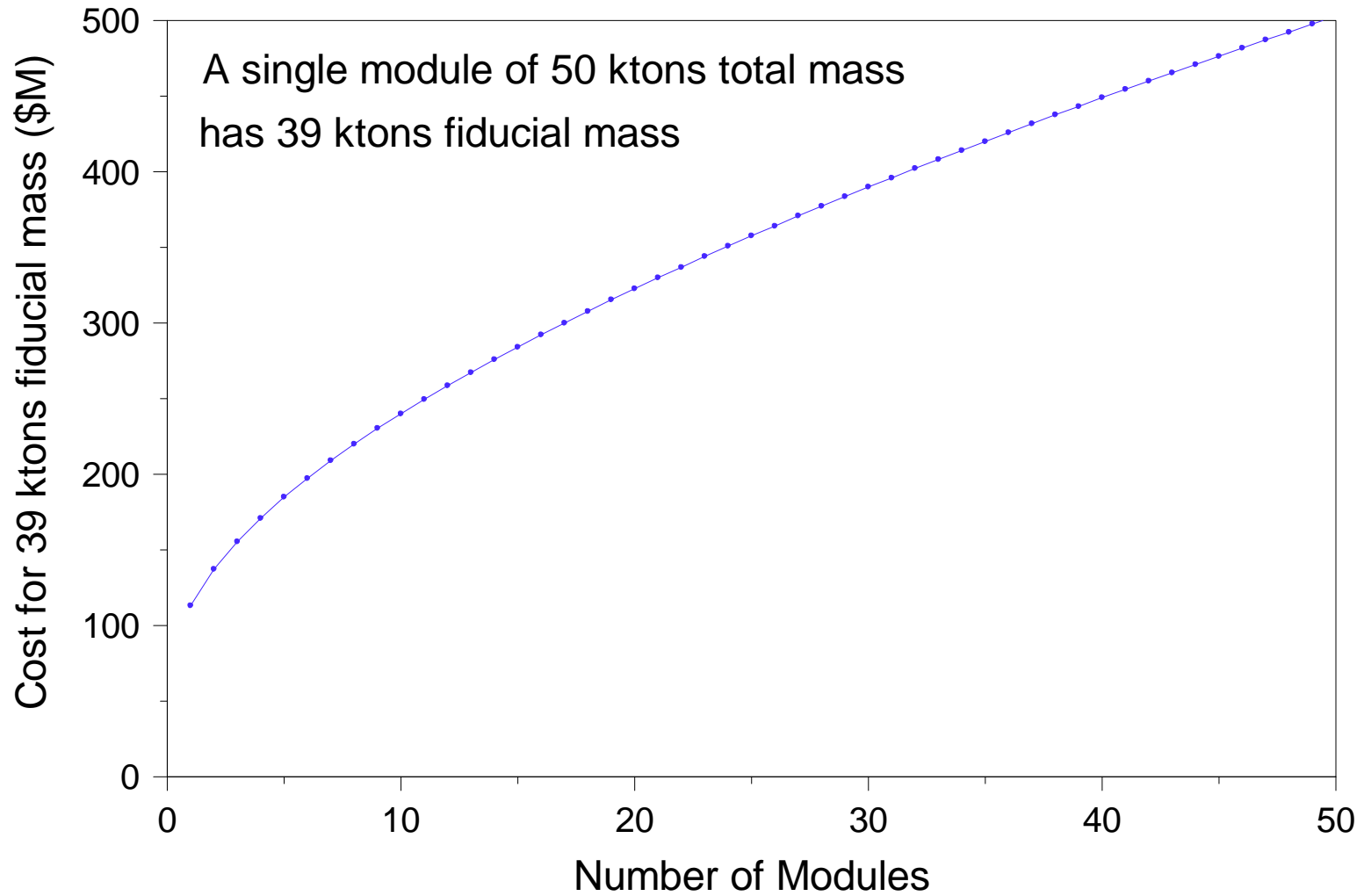

For 39 kton fiducial mass (50 kton total mass if only 1 module),  
Cost multiplied by 2 if build 8 modules rather than 1.  
Cost multiplied by 4 if build 40 modules.

8. Resolution. Segmentation.

ICARUS design with 3-d pixelation of  $1 \times 3 \times 3 \text{ mm}^2$  may be finer than necessary.  
More on this later.

9. Maintenance and operational issues. Repairability. Failure modes and risks.

The main detector is a sealed system  $\Rightarrow$  Must be well built! Primary failure modes are broken wires (more later) or  $\text{O}_2$  poisoning of the liquid argon.

10. Near detector issues.

Should build a liquid argon near detector at the neutrino source!

11. R&D issues. Time scale?

Issues for a wire-based detector are reviewed on p. 22.

Issues for a pad-readout detector are discussed on pp. 23-24.

12. Time to construct and install.

Roughly 2 years to construct the storage tank, 1 year to construct the detector and (in parallel) the argon purification system, 1 year to fill the tank,  
 $\Rightarrow$  4 years total construction.

# Is a 100-kton Liquid Argon Detector Feasible?

- Use mature, low-cost technology of liquid methane storage tanks (up to 300 kton based on existing structures).  
Preliminary budget estimate from industry of < \$20M for a 100-kton tank, IF built on the SURFACE.
- 100 kton of liquid argon = 10% of USA annual production.  
⇒ Deliver one trailer-load every 2 hours from Chicago,....  
Only 5 ppm O<sub>2</sub> grade available in large quantities,  
⇒ On-site liquid-phase purification via Oxisorb (MG).  
Raw material, delivery + purification ⇒ \$0.8M/kton.
- ICARUS electronics from CAEN @ \$100/channel.  
3 mm wire spacing ⇒ 300k ch ⇒ \$30M.  
9 mm wire spacing ⇒ 100k ch ⇒ \$10M.  
High capacity of long wires  
⇒ Signal may be too weak to use 3 mm spacing.
- With neutrino beam, record every pulse ( $10^{-3}$  duty factor).  
Cosmic rays occupy  $\approx 10^{-3}$  of active volume,  
⇒  $\approx 10$  MB data per trigger.  
⇒ Modest (< \$10M) DAQ/computer system.
- Engineering feasibility survey by G.T. Mulholland (Aug 2002):  
[http://www.hep.princeton.edu/~mcdonald/nufact/mulholland/ELAN\\_Proposal.pdf](http://www.hep.princeton.edu/~mcdonald/nufact/mulholland/ELAN_Proposal.pdf)



# 200-kton Cryogenic Tanks Used for LNG Storage

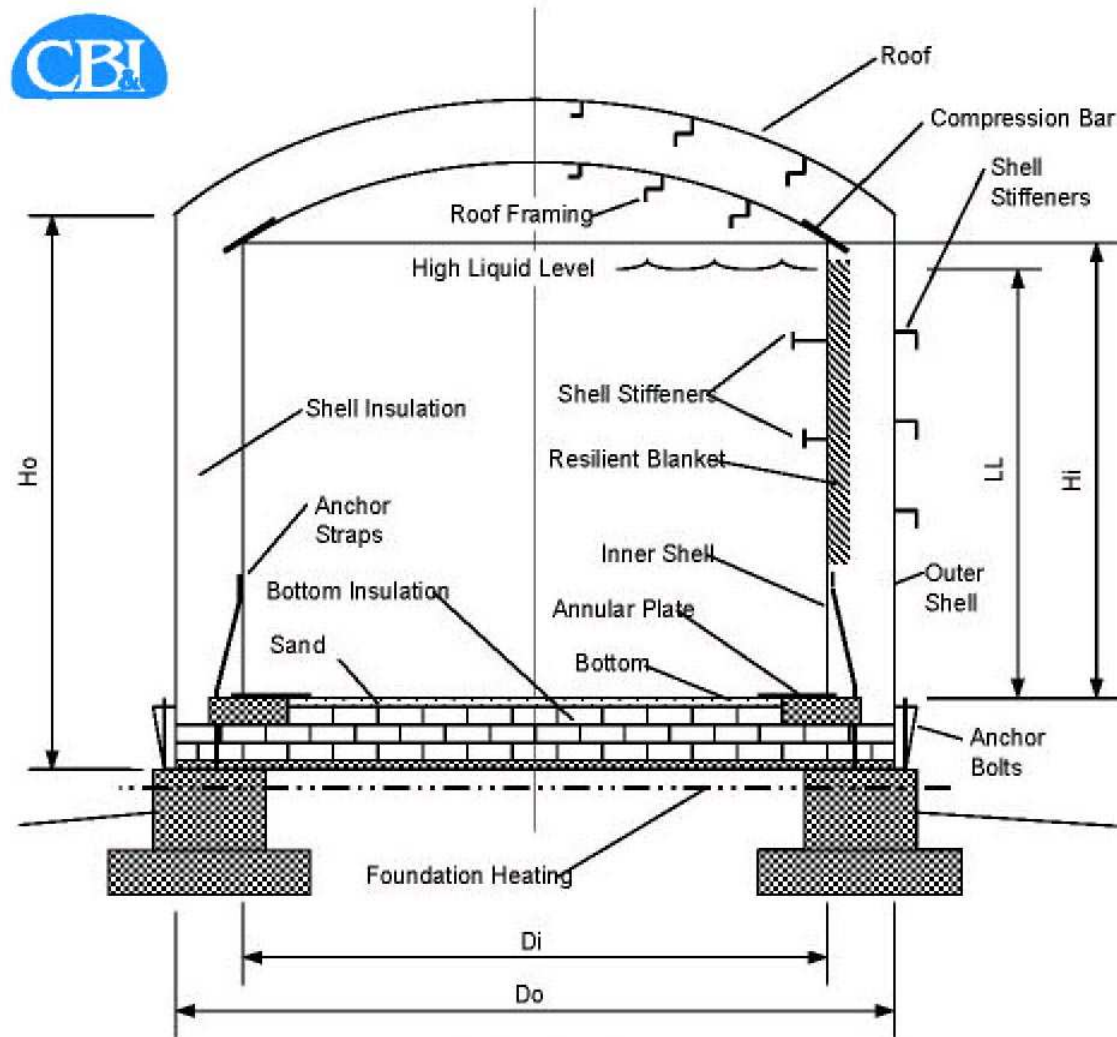

Double Wall & Double Roof Tank

	Feet
Di =	165
Hi =	117.9803
LL =	117.7303
Do =	173
Ho =	118.0443

**Chicago Bridge & Iron: can build 100-kton LAr tank for < \$20M.**

# Strong Interest by Praxair

- Praxair is the leading USA vendor of liquid argon.
- The Praxair R&D Lab in Tonawanda, NY is same Union Carbide lab that provided the expertise to build the Oak Ridge gaseous diffusion plant in the 1940's.

## LANNDD Cryogenic System

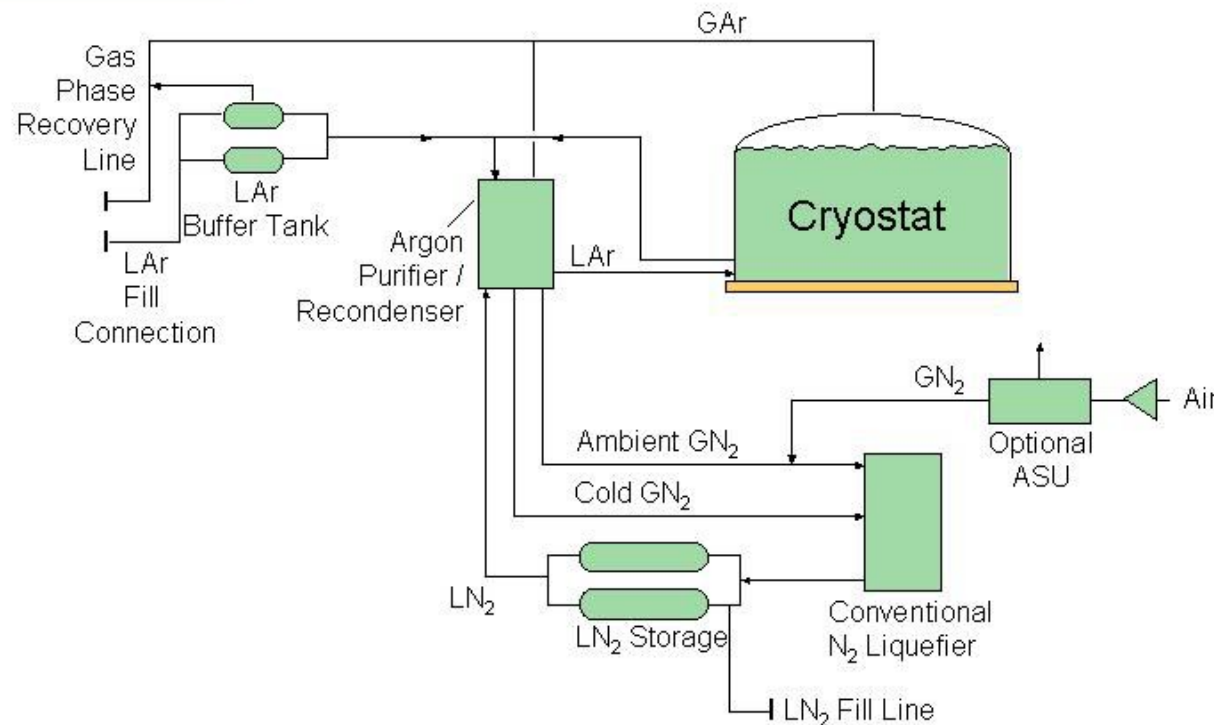

PRAXAIR BUSINESS CONFIDENTIAL

aml-9/2002-DPB 1

## Extrapolation to Very Large Modules

**Preliminary cost estimate for a liquid argon detector of 100 kton total mass.**

Component	Scaling	Cost
Liquid argon (industrial grade)	$M$	\$70M
Cryo plant, including Oxisorb purifiers	$M$	\$10M
Surface site preparation	$M^{2/3}$	\$10M
Cryogenic storage tank	$M^{2/3}$	\$20M
Electronics (300k channels)	$M^{2/3}$	\$30M
Computer systems	$M^{2/3}$	\$10M
<b>Subtotal</b>		<b>\$150M</b>
<b>Contingency</b>		<b>\$50M</b>
<b>Total</b>		<b>\$200M</b>

Fiducial mass is for  $\nu_e$  appearance events  $\Rightarrow$  contain EM showers.

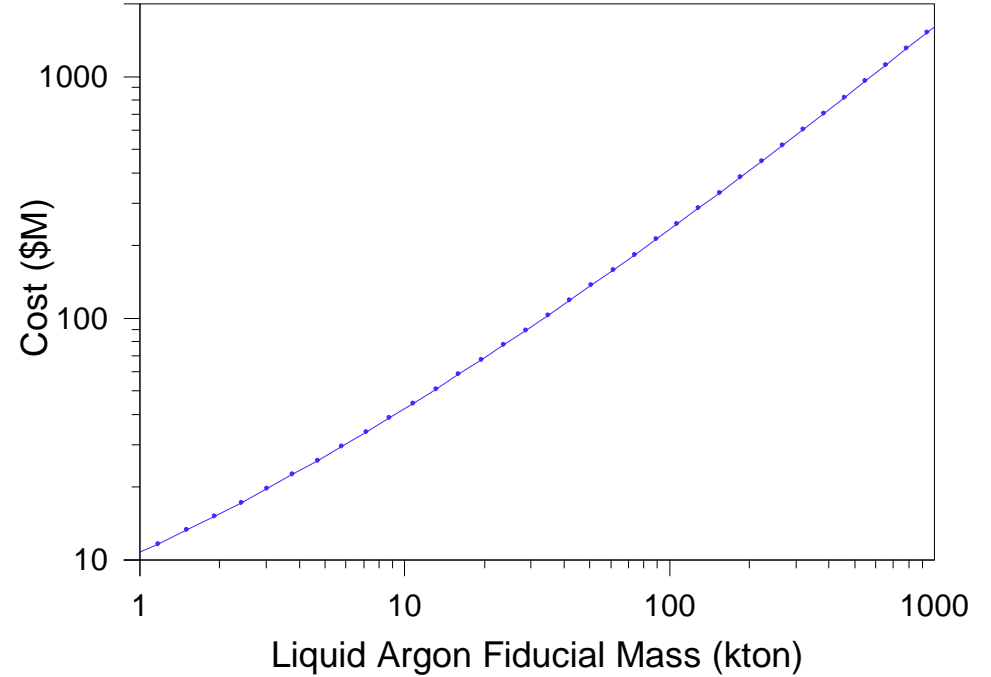
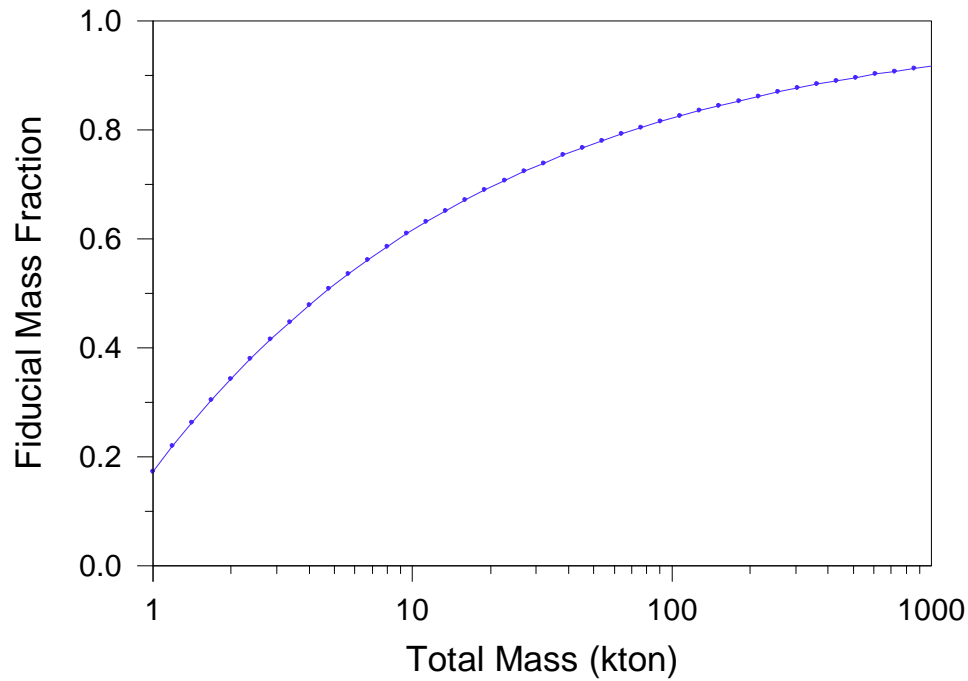

**Cost scaling =  $1.33 [\$80\text{M} (M/100 \text{ kton}) + \$70\text{M} (M/100 \text{ kton})^{2/3}]$ .**



## Next Steps

- 40-ton near detector (1.5-ton fid. mass) as a near detector in a neutrino beam.

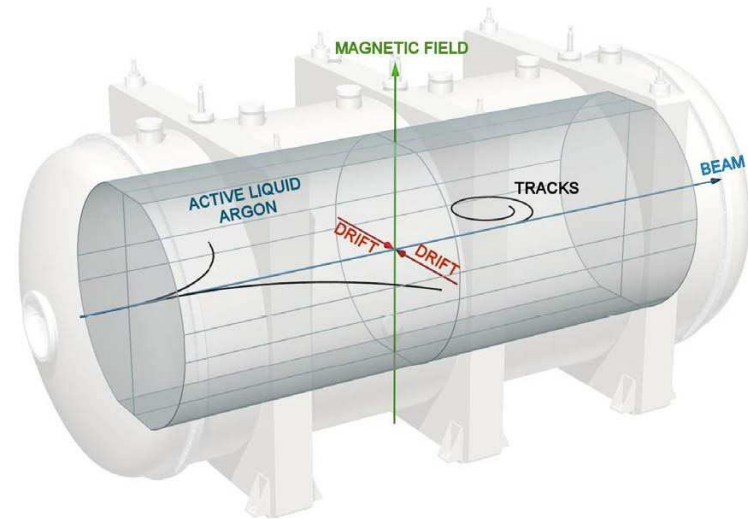

Chicago Cyclotron Magnet coil

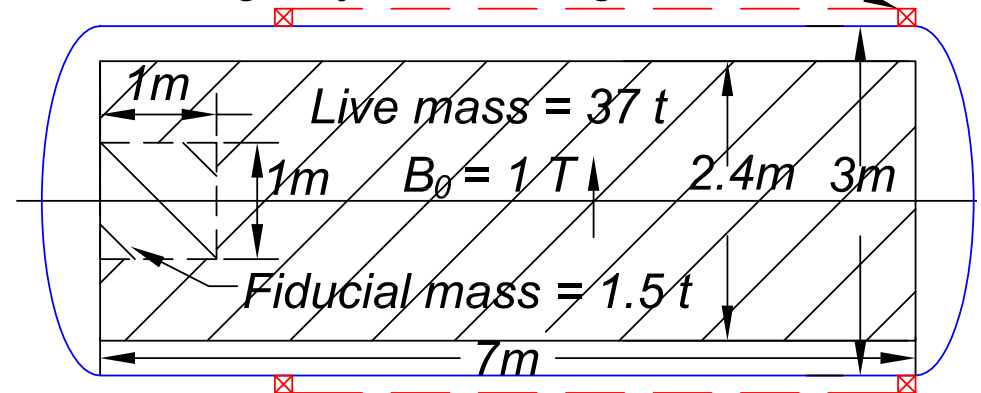

- Add Chicago Cyclotron Magnet coils to give  $B \approx 1 \text{ T}$  over downstream (or upstream) 2/3 of detector.  
 $\Rightarrow 10^5 \text{ CC } \nu_\mu \text{ interactions/year.}$
- [astro-ph/0301545](https://arxiv.org/abs/astro-ph/0301545)

# R&D for a Large Liquid Argon TPC with Wire Readout

- **Liquid-phase purification of industrial grade argon via Oxisorb or equivalent (Prax-air).**
- **Verification of 5-m drift with good signal collection (Pisa/UCLA).**
- **Mechanics and electronics of wires up to 60-m long.**
- **Cryogenic feedthroughs, possibly including buffer volume at 150K for low-noise FET's.**
- **Verification of operation of a liquid argon TPC at 10 atmospheres (as at bottom of a 100-kton tank).**
- **Study of liquid argon TPC in a magnetic field (BNL P-965, CERN LOI).**

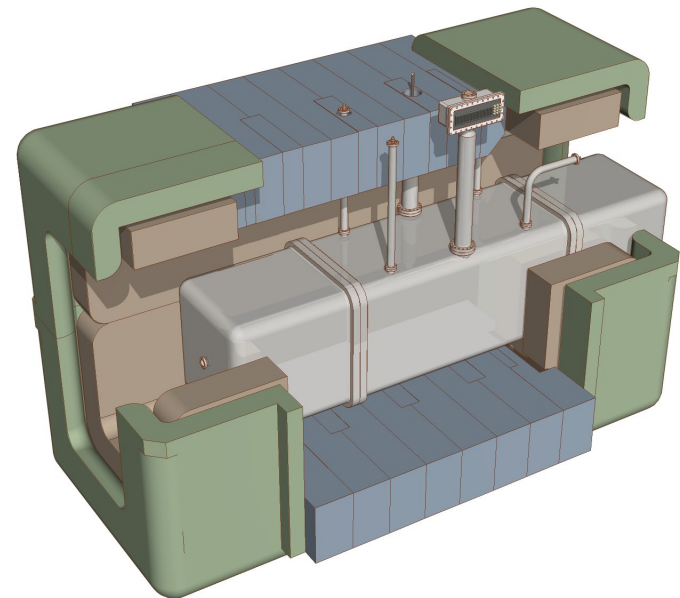
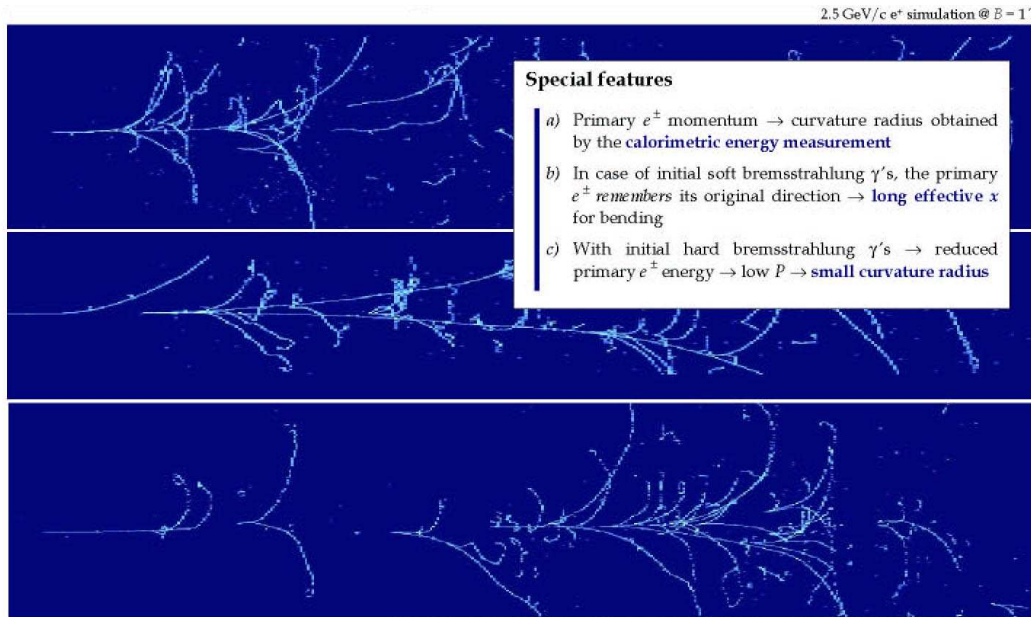

A. Bueno, M. Campanelli, A. Rubbia, IX International Workshop on "Neutrino Telescopes", VENICE, 2001

**Should identify sign of  $e^\pm$  up to  $\approx 3$  GeV in a 0.5-T field.**

## Pad *vs.* Wire Readout

- Classic time projection chamber design is based on 2-d pixels (pads) + time sampling,  
⇒ Unambiguous 3-d pixels.
- Large channel count in large detector with tiny pixels,  
⇒ Wire-based readout in ICARUS design.
- Wire-based readout,  
⇒ Must reconstruct 3-d pixels from 2-d projections, resolving “ghost” ambiguities,  
⇒ Extra complexity to software.
- Wire-based readout uses collection wires + 2 planes of “induction” wires.  
But inductive readout is difficult when tracks lie close to the drift electric field lines,  
⇒ Less than full solid angle can be reconstructed.
- Wire-based readout is vulnerable to wire breakage.  
A design based on classic method of attachment of piano wires to pegs is robust, but consequences of a wire failure system are severe.
- Wire-based readout is vulnerable to “microphonics” (differential vibration of wires at audio frequencies),  
⇒ Baseline shifts,  
⇒ Hard to do “zero suppression” online,  
⇒ Much larger data flow off the detector.

# Pad Readout for a Very Large Detector?

- Lower the channel count by coarser pixelation.  
Ex:  $1 \times 1 \times 1 \text{ cm}^3$  pixels (recall that  $X_0 = 14 \text{ cm}$  in LAr),  
 $\Rightarrow 10,000 \text{ ch/m}^2$  with 512-deep time-sampling over a 5-m drift.
- Take further advantage of large-scale integration of front-end electronics.  
(STAR TPC uses 16-ch/chip.)
  - Feature width of 0.2 mm/ch of analog electronics probably can't be reduced, but if arrange channels in 2 rows, could put 256 ch on a  $20 \times 40 \text{ mm}^2$  die.
  - Cost of \$100 per 256-ch readout chip (\$0.40/ch)  
 $\Rightarrow$  \$4k/m<sup>2</sup> of readout area.
  - 30 kton detector ( $h = 2r = 30 \text{ m}$ ) would have 3,000 m<sup>2</sup> of readout,  $\Rightarrow$  \$12M readout cost.  
(Same as for wire-based readout with ICARUS pixel size.)
- New R&D Topics for a Large Liquid Argon TPC with Pad Readout:
  - Simulations to study effect of pixel size.
  - Development of larger-scale front-end readout chips.
  - Verify operation of front-end electronics in liquid argon.  
(1 mW/ch  $\Rightarrow$  30 kW additional heat load. Bubbling near readout chips.)