

# The High-Power-Target System of a Muon Collider or Neutrino Factory

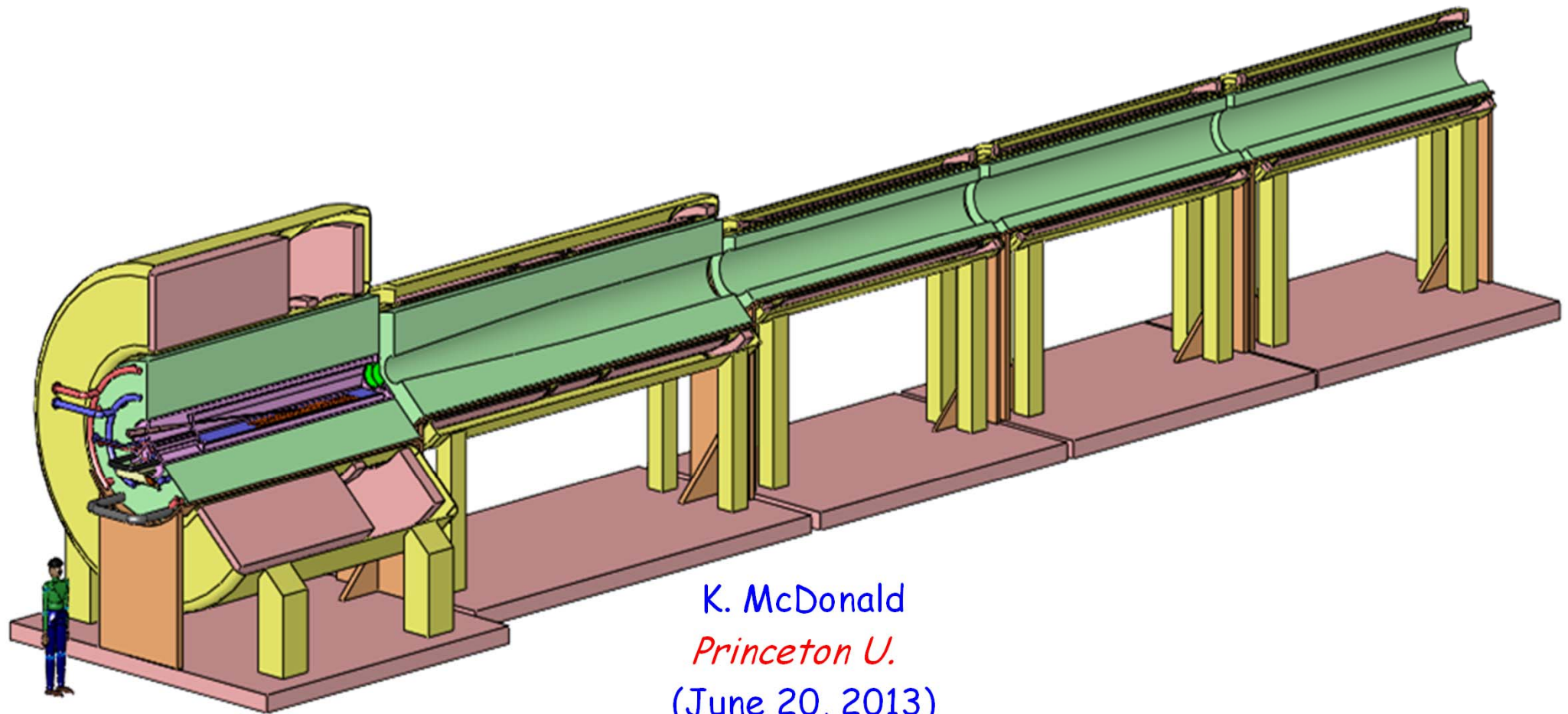

K. McDonald  
*Princeton U.*  
(June 20, 2013)

Muon Accelerator Program Collaboration Meeting  
*FNAL*



# History of Target & Capture Options for a Muon Collider

---

Early thoughts by Dave Neuffer in 1981,

[http://puhep1.princeton.edu/~mcdonald/examples/accel/neuffer\\_ieetns\\_28\\_2034\\_81.pdf](http://puhep1.princeton.edu/~mcdonald/examples/accel/neuffer_ieetns_28_2034_81.pdf)

Considered (toroidal-field) Li lenses,  $\Rightarrow$  2 target stations to collect both signs.

Fernow *et al.* reviewed options in March 1995,

[http://puhep1.princeton.edu/~mcdonald/examples/accel/fernaw\\_aipcp\\_352\\_134\\_95.pdf](http://puhep1.princeton.edu/~mcdonald/examples/accel/fernaw_aipcp_352_134_95.pdf)

Li lenses, plasma lenses, toroidal horns, and solenoidal capture.

All of the pulsed, toroidal systems would be well beyond present technology, so the solenoid capture system began to be favored.

The advantage of transverse-longitudinal emittance exchange (a kind of transverse cooling) via use of a high-field capture solenoid with downstream field tapering to a lower value was appreciated from the beginning.

The option of a mercury jet target may have been first considered by Palmer *et al.* in late 1995,

[http://puhep1.princeton.edu/~mcdonald/examples/accel/palmer\\_aipcp\\_372\\_3\\_96.pdf](http://puhep1.princeton.edu/~mcdonald/examples/accel/palmer_aipcp_372_3_96.pdf)

The issue of radiation damage to superconductors was appreciated early on, but MARS without the MCNP data significantly underestimated damage due to low-energy neutrons.



# Target and Capture Topology: Solenoid

Desire  $\approx 10^{14}$   $\mu/s$  from  $\approx 10^{15}$  p/s ( $\approx 4$  MW proton beam)

R.B. Palmer (BNL, 1994) proposed a 20-T solenoidal capture system.

Low-energy  $\pi$ 's collected from side of long, thin cylindrical target.

Solenoid coils can be some distance from proton beam.

$\Rightarrow$   $\geq 10$ -year life against radiation damage at 4 MW.

Liquid mercury jet target replaced every pulse.

Proton beam readily tilted with respect to magnetic axis.

$\Rightarrow$  Beam dump (mercury pool) out of the way of secondary  $\pi$ 's and  $\mu$ 's.

## IDS-NF Target Concept:

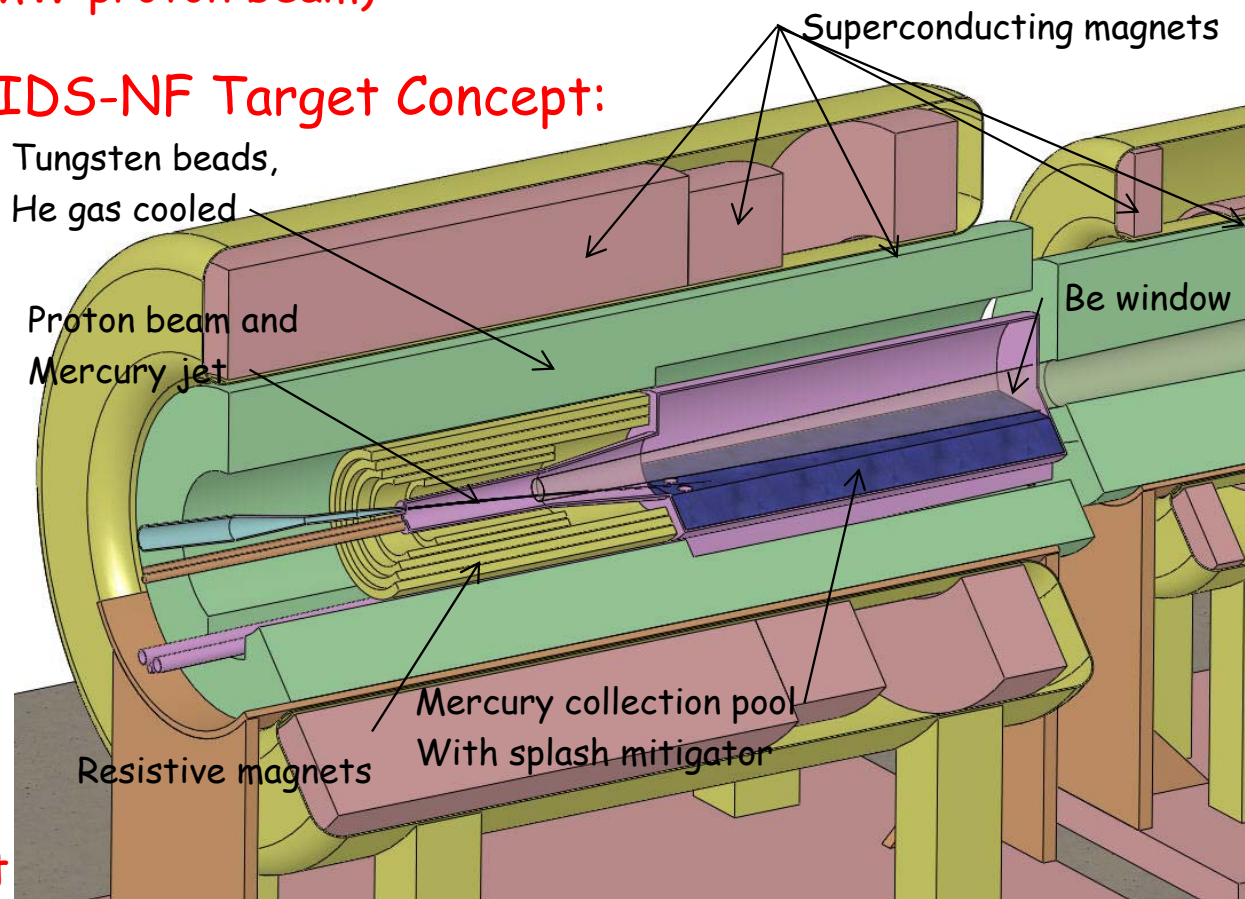

Shielding of the superconducting magnets from radiation is a major issue.

Magnet stored energy  $\sim 3$  GJ!

5-T copper magnet insert; 15-T  $Nb_3Sn$  coil + 5-T NbTi outsert.

Desirable to replace the copper magnet by a 20-T HTC insert (or 15-T Nb coil).



# Large Cable-in-Conduit Superconducting Magnets

The high heat load of the target magnet requires Nb<sub>3</sub>Sn cable-in-conduit technology, more familiar in the fusion energy community than in high energy physics.

## Central Solenoid (CS) Model Coil

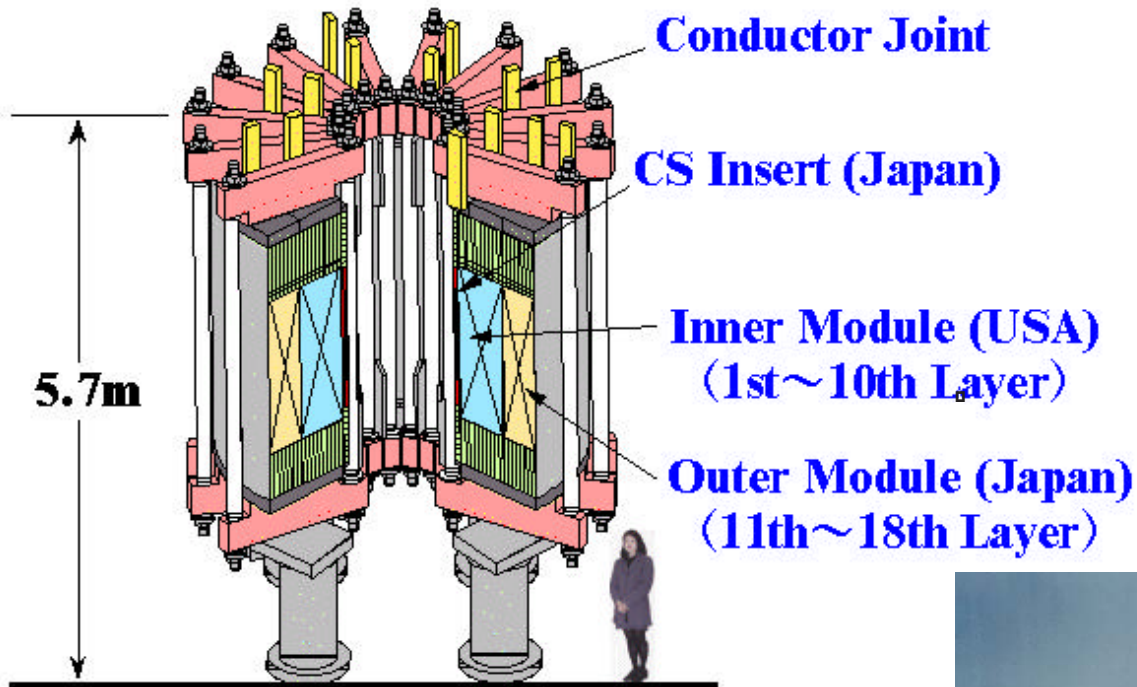

The conductor is stabilized by copper, as the temperatures during conductor fabrication comes close to the melting point of aluminum.

The conductor jacket is stainless steel, due to the high magnetic stresses.

A high-temperature superconducting insert of 6+ T is appealing - but its inner radius would also have to be large to permit shielding against radiation damage.

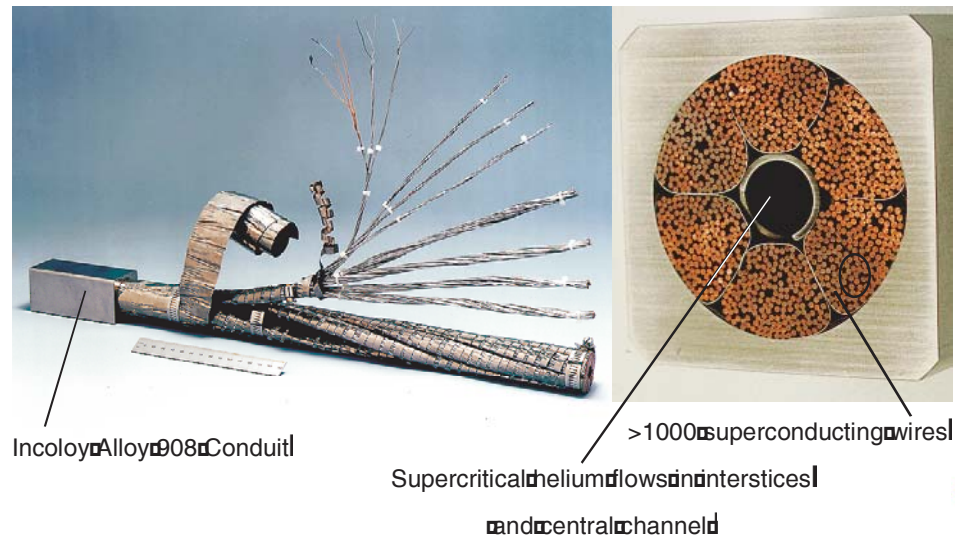

# Copper Conductor for Radiation-Resistant Magnets

Organic insulation cannot be used in copper coils in the Target System.

Radiation-resistant conductor with MgO insulation has been developed at KEK/JHF.

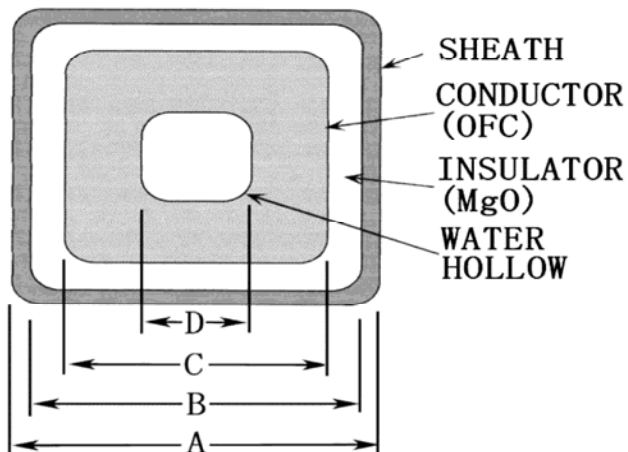
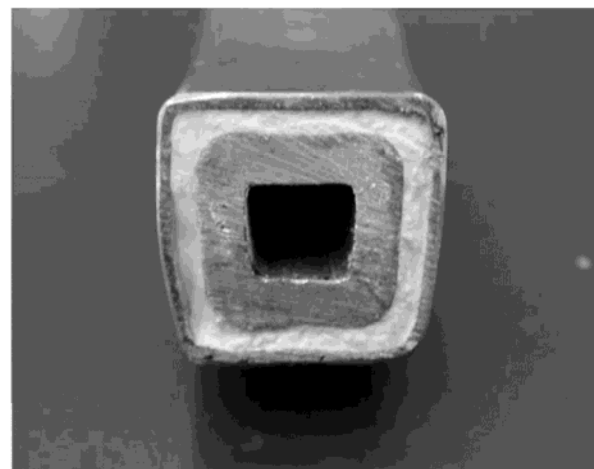

TABLE I  
PARAMETERS OF Q440MIC TYPE Q-MAGNET

Magnet length:	2000 mm
Magnet bore diameter:	200 mm
Magnet weight:	33000 kg
Nominal current:	2200 A
Nominal voltage:	200 V
Nominal water pressure drop:	1.0 MPa
Required cooling water:	290 liter/min.
Cooling water temp. rise:	30 deg. centigrade
Field at pole:	1.3 tesla

Nominal Current (A)	2000	2500	3000	1000*	2000*
Dimensions (mm)					
A: Outward Size	20.0	23.8	28.0	18.0	14.0
B: Insulator Size	18.0	21.6	25.0	16.6	12.6
C: Conductor Size	14.6	18.0	20.0	13.2	9.2
Cross Sections (mm <sup>2</sup> )					
Conductor	150.9	211.7	293.1	168.4	78.8
Insulator	117.7	153.2	227.4	106.6	79.4
Sheath	73.4	95.3	150.6	47.8	36.6

\*indicates Solid Conductor MICs. No hollow is in Cu conductor.



402

IEEE TRANSACTIONS ON APPLIED SUPERCONDUCTIVITY, VOL. 14, NO. 2, JUNE 2004

## Development of Radiation Resistant Magnets for JHF/J-PARC

K. H. Tanaka, E. Hirose, H. Takahashi, K. Agari, A. Toyoda, Y. Sato, M. Minakawa, H. Noumi, Y. Yamanoi, M. Ieiri, Y. Katoh, Y. Yamada, Y. Suzuki, M. Takasaki, T. Birumachi, S. Tsukada, Y. Saitoh, N. Saitoh, K. Yahata, K. Kato, and H. Tanaka

# Recent Targetry Efforts

---

Jaroslav Pasternak (IC, London) *Proton-beam final focus*

Xiaoping Ding (UCLA) *Particle-Production Simulations* (including comparison of Ga with Hg)

Ole Hansen (CERN) *Jet Target Optimization*

Hisham Sayed (BNL) *Configurations with shorter taper* (matched to phase rotator)

Bob Weggel (MORE/PBL) *Magnet and Shielding Configurations*

Nicholas Souchlas (PBL) *Energy-deposition simulations for the Target System* (to determine whether the superconducting magnets are sufficiently well shielded from the 4-MW beam power)

Pavel Snopok (IIT) *Energy-deposition simulations for the Decay Channel*

Van Graves (ORNL) *Mercury module design + overall Target System layout*

Yan Zhan (Stony Brook) *Nozzle and Jet Studies* (towards improving the jet quality)

Roman Samulyak (Stony Brook) *MHD Simulations* (including beam-jet interactions)



# Proton-Beam Final Focus

Jaroslav Pasternak (IC, London) [IPAC13, TUPFI074]

The ~ 8-GeV, 4-MW proton beam that drives a Neutrino Factory has a nominal 50-Hz macropulse structure with 2-3 micropulses ~ 100 ns apart.

The nominal geometric beam emittance is 5  $\mu\text{m}$ , and the desired rms beam radius at the liquid-metal-jet target is 1.2 mm.

A quadrupole-triplet focusing system to deliver this beam spot is described.

## Proton-beam transport from Compressor Ring to the Target System:

The ~ 250-m-long arc system maintains the 2-ns proton-bunch length without RF cavities:

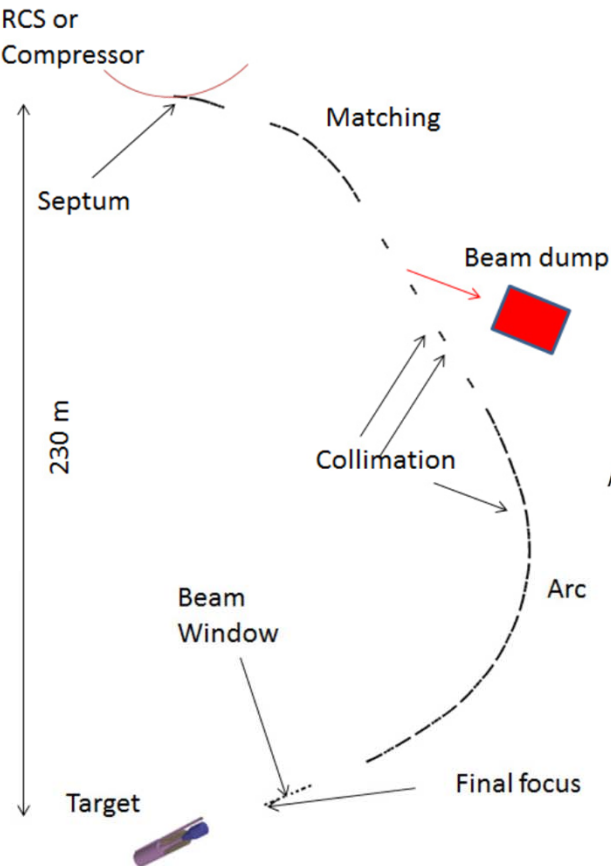

$\beta$ -Function and Dispersion of a 17-m-long cell of the arc system:

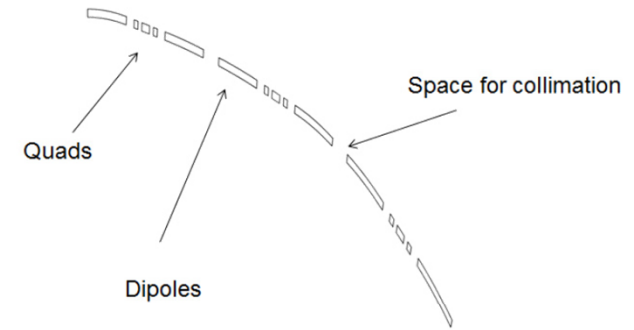
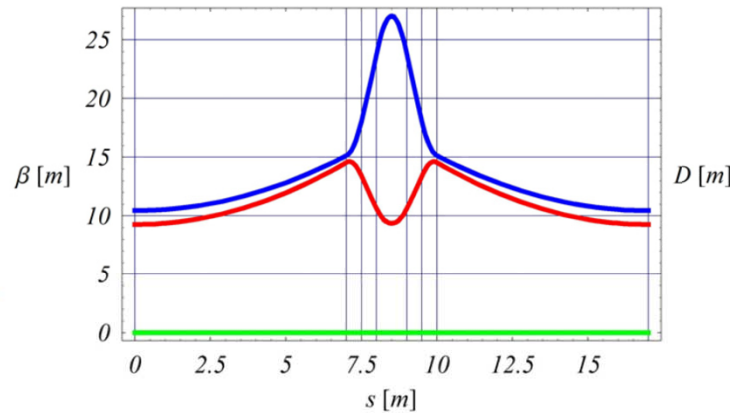

$\beta$ -Function of the last 70 m of a Final-Focus system with 5-m gap between last quad and target (which is at  $s = 70$  m):

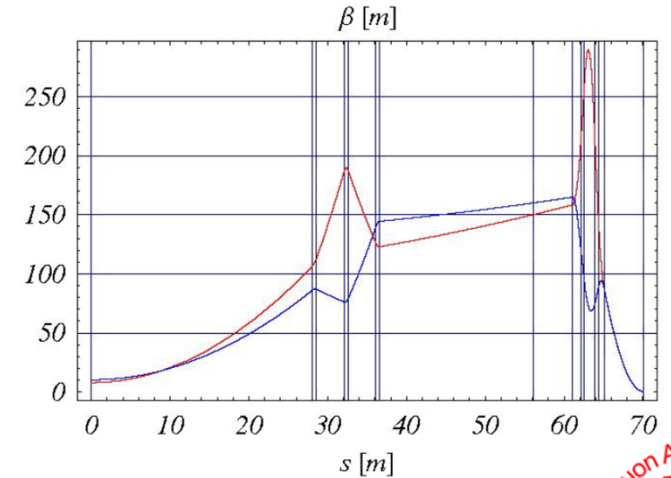

# Particle Production Simulations

Xiaoping Ding (UCLA) [IPAC13, TUPFI069]

The geometric parameters of a free Hg or Ga jet target for a Muon Collider or Neutrino Factory were optimized to maximize particle production by an incident, parallel proton beam with kinetic energies (KE) between 2 and 16 GeV using the MARS15 code.

The optimized parameters were: the radius of the proton beam, the radius of the liquid jet, the crossing angle between the jet and the proton beam, and the incoming proton beam angle.

We extended our optimization to focused proton beams for special cases of transverse emittances of 2.5, 5 or 10  $\mu\text{m-rad}$  at a KE of 8 GeV.

We also studied the effect of a shift of the beam focal point relative to the intersection point of the beam and the jet.

## 1. Optimized target parameters and meson production for incoming proton beam with zero emittance

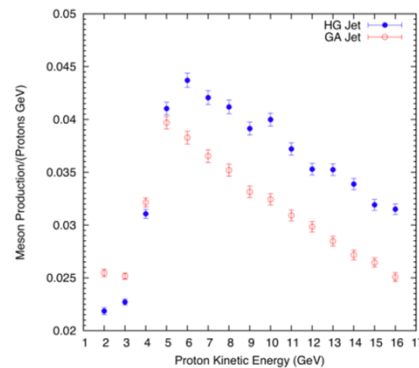
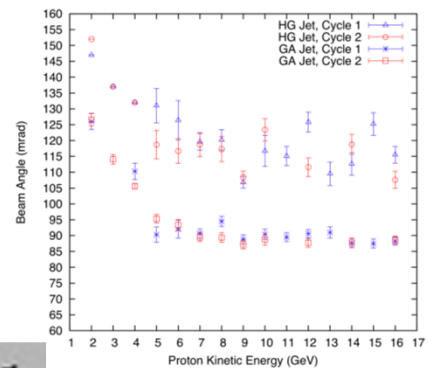
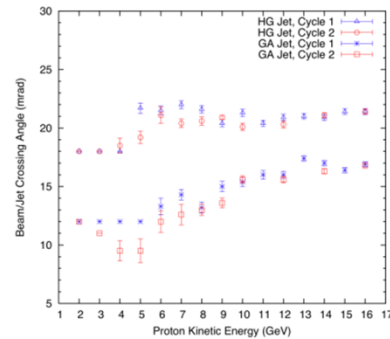
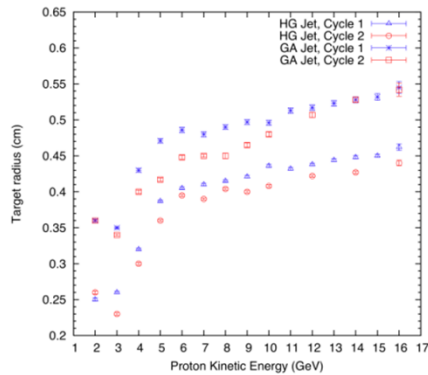

Meson production at low proton KE (below 4 GeV) may be higher for Ga than for Hg.

## 2. Influence of proton beam emittance on particle production

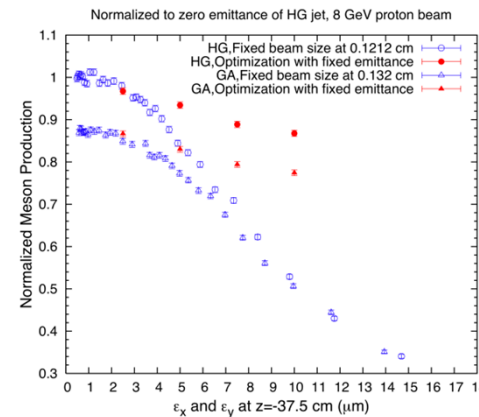

Meson production decreases with increasing proton beam emittance, but careful optimization keeps this decrease to 7% for a Hg-jet target and 4% for a Ga-jet target for a proton beam of 8 GeV kinetic energy and transverse emittance  $\epsilon = 5 \mu\text{m-rad}$ , compared to the case of zero emittance beams. The optimized meson production a Ga-jet target is then about 88% of that for a Hg-jet target.

## 3. Effect of shift of the beam focal point

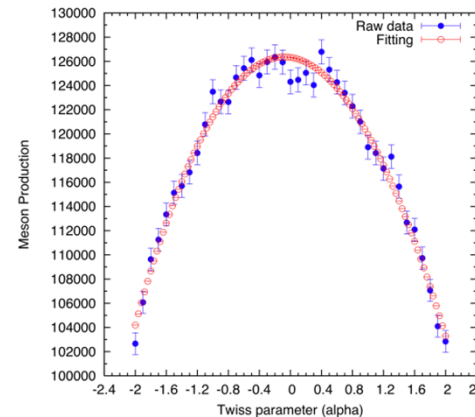

Meson production peaks when the beam focal point is about 5 cm upstream of the beam/jet interaction point, but the increase compared to focal point at the interaction point is negligible.





# Jet Target Optimization

Ole Hansen (CERN) [IPAC13, TUPFI018]

Little change in particle production if jet is elliptical rather than circular:

[Confirms old result of H Kirk that a "waterfall" target would be fine.]

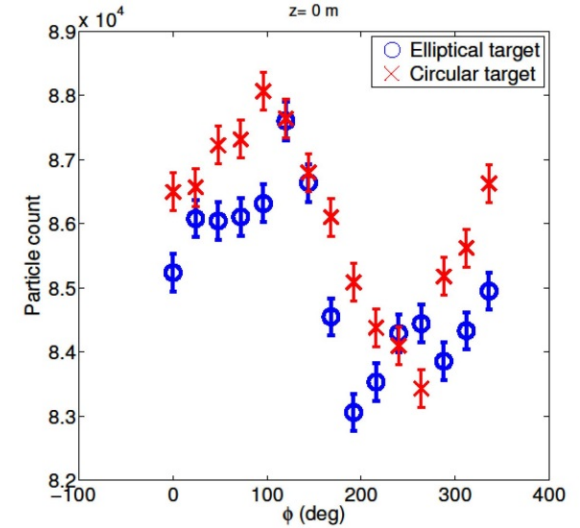

Small shifts in the target position relative to the nominal can improve the particle production:

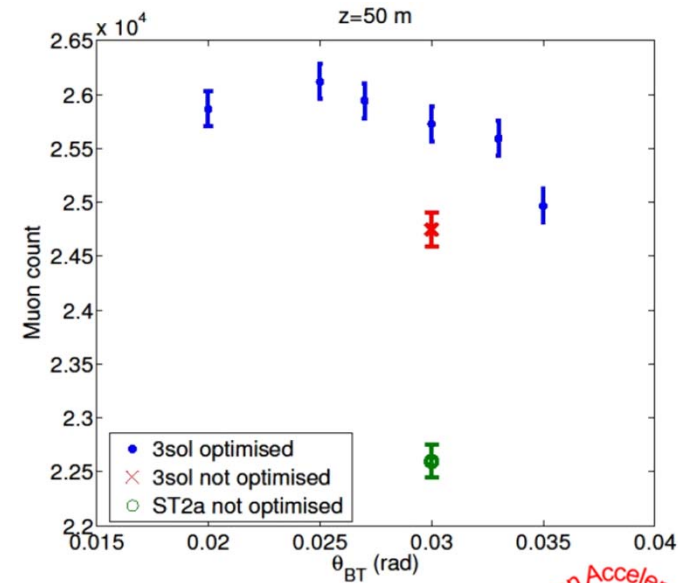
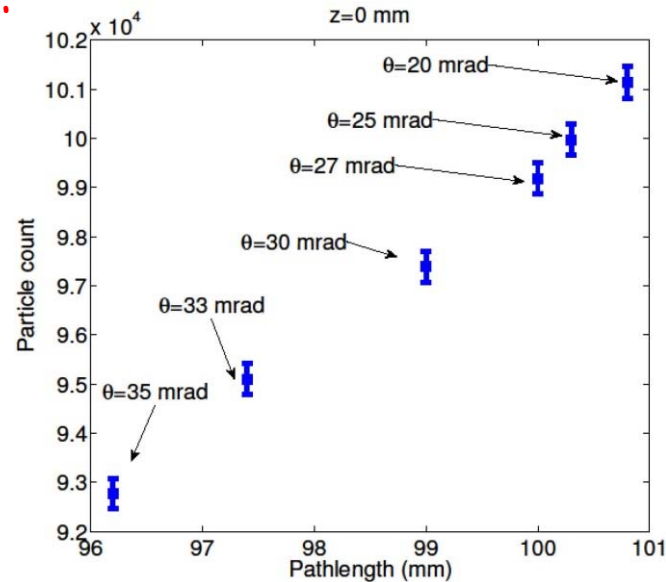
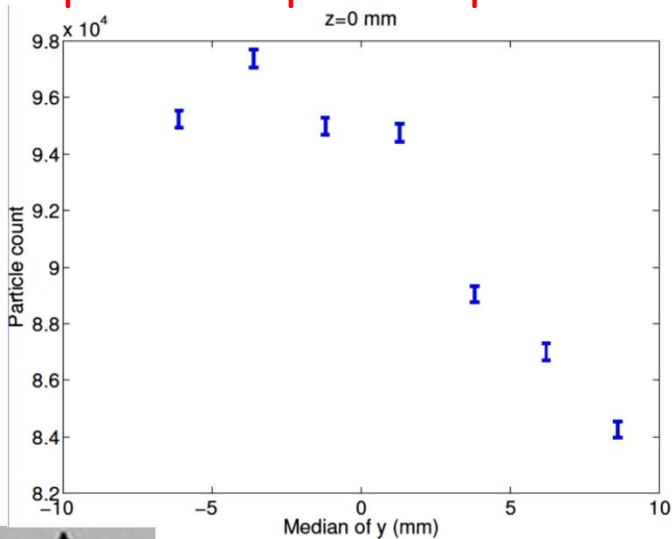

H Saged: Similar effects if shift time of proton beam.

# Configurations with a Shorter Taper

Hisham Sayed (BNL) [IPAC13, TUPFI075]

Following a hint from O. Hansen, the yield of useful muons out of the Phase Rotator (Front End), is improved by shifting the timing of the proton beam, and shortening the length of the taper between 20 T and 1.5 T.

The baseline taper length of 15 m could be reduced to ~ 5 m.

Reducing the peak field from 20 T to 15 T is viable.

The shorter taper results in a denser distribution in longitudinal phase space, which is preferable for the Buncher/Phase Rotator.

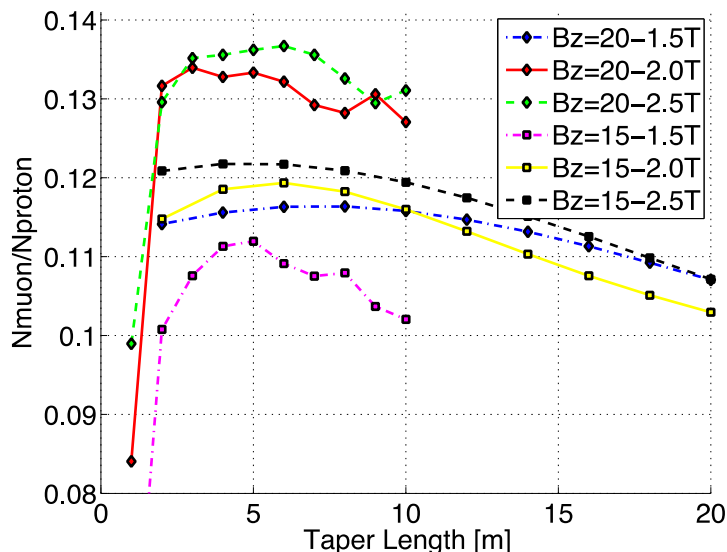

It seems favorable to increase the field in the Front End above the baseline of 1.5 T.

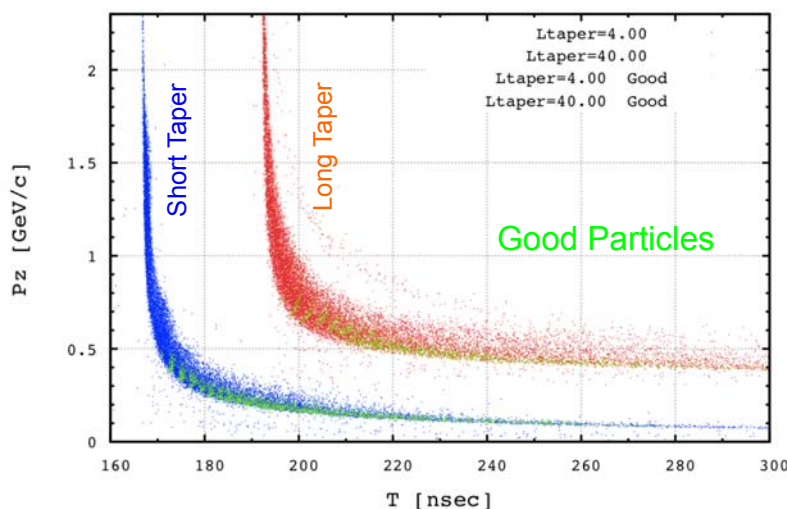
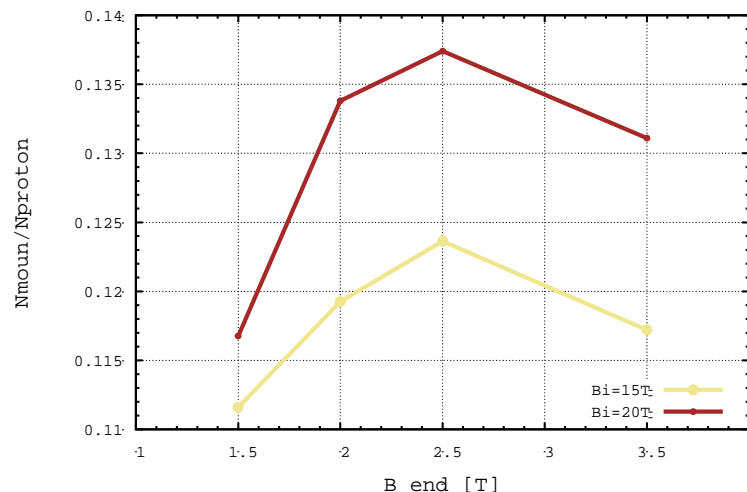

A short proton bunch continues to be favored:

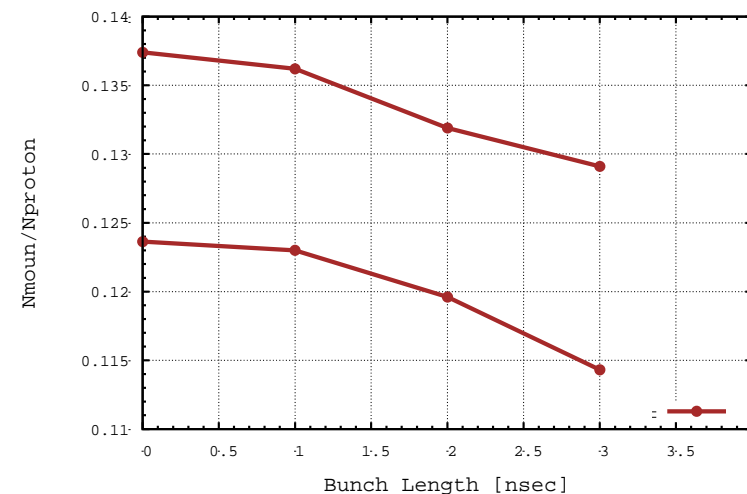

# Magnet Coil Configurations

Bob Weggel (MORE/PBL) [IPAC13, TUPFI073]

Field perturbations at the ends of the 5-m-long Decay channel magnets can lead to "stop bands."

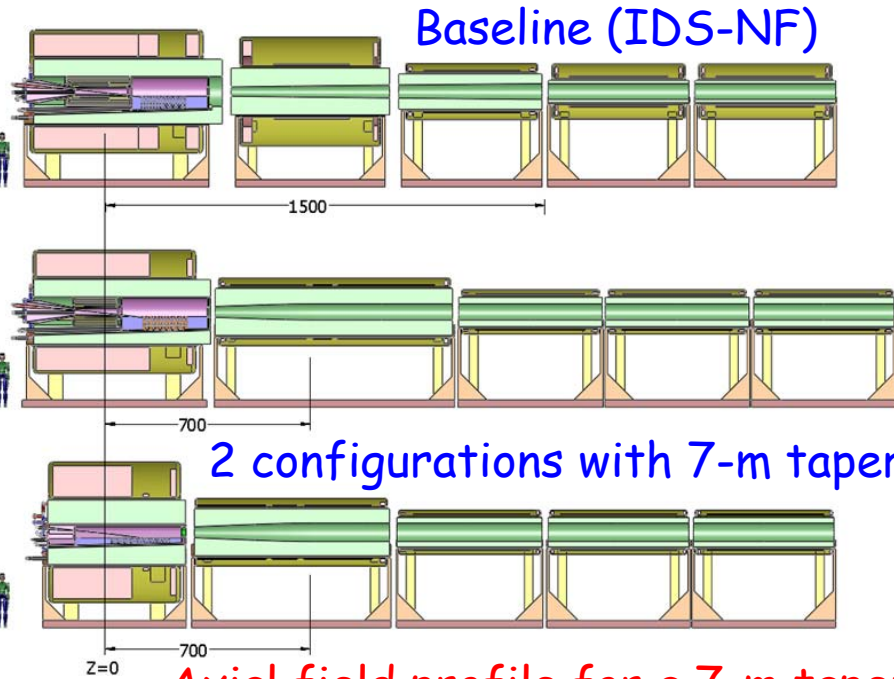

2 configurations with 7-m taper and 15-T peak

Axial field profile for a 7-m taper:

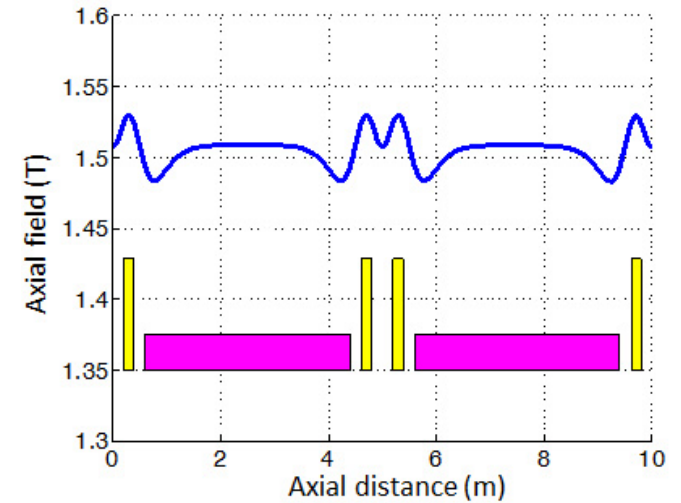
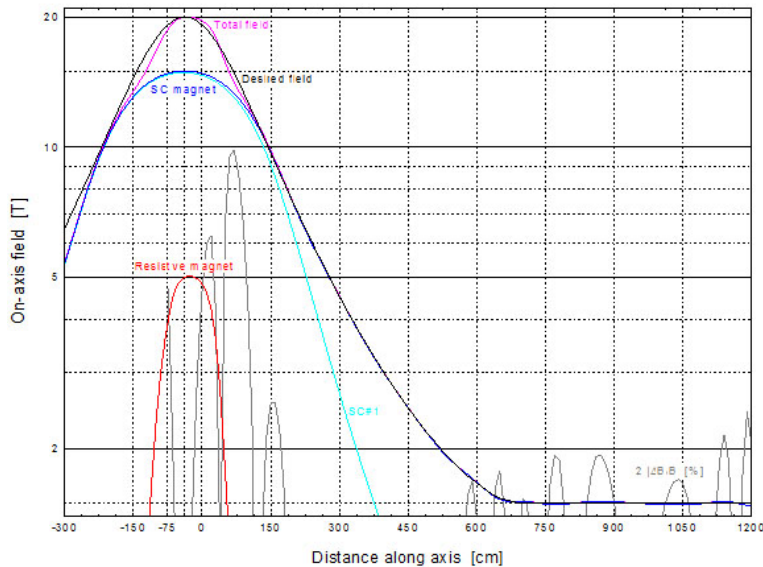

Revised coil configuration has essentially no "stop bands" (H. Sayed):

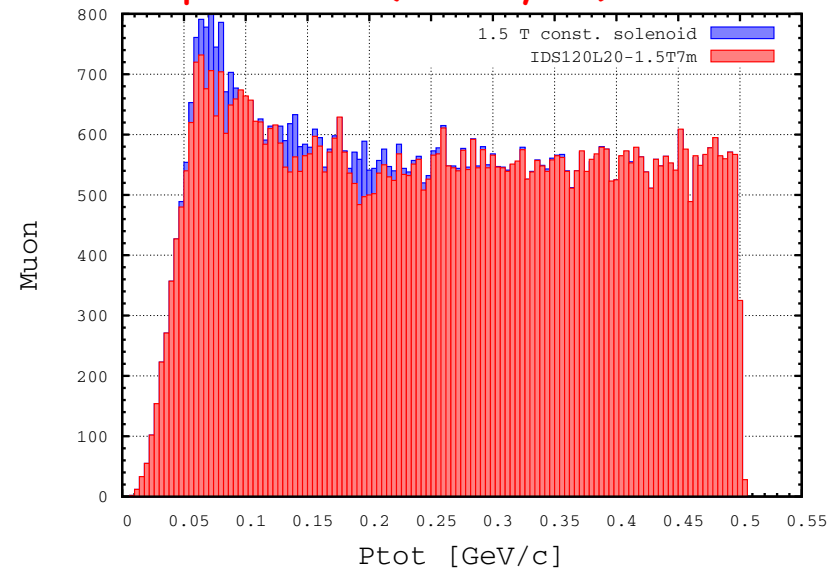

# Energy-Deposition Simulations

Nicholas Souchlas (PBL)

Possibly noncircular mercury target module could lead to "hot spots" in downstream coils.

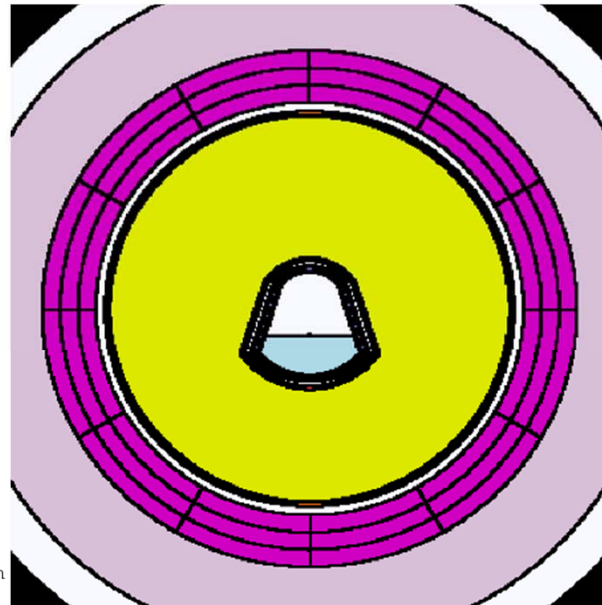
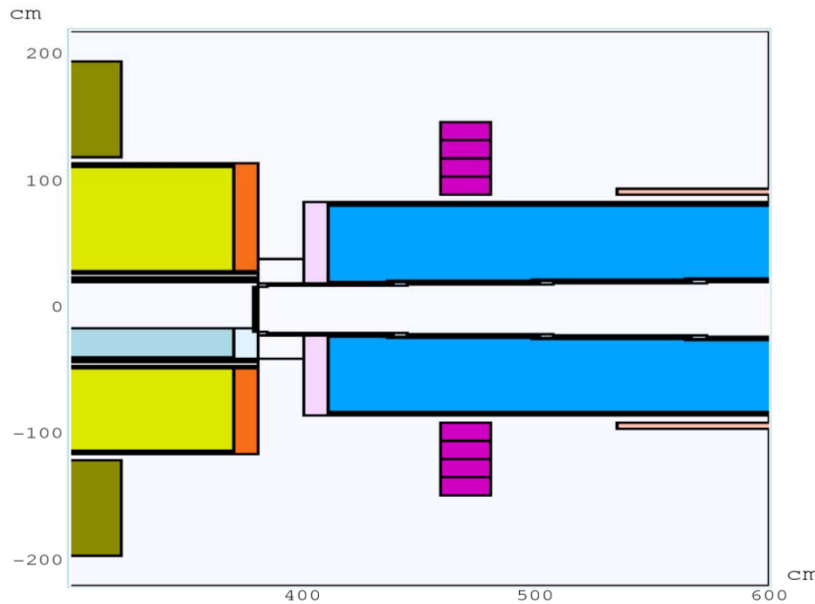

$z = 0$

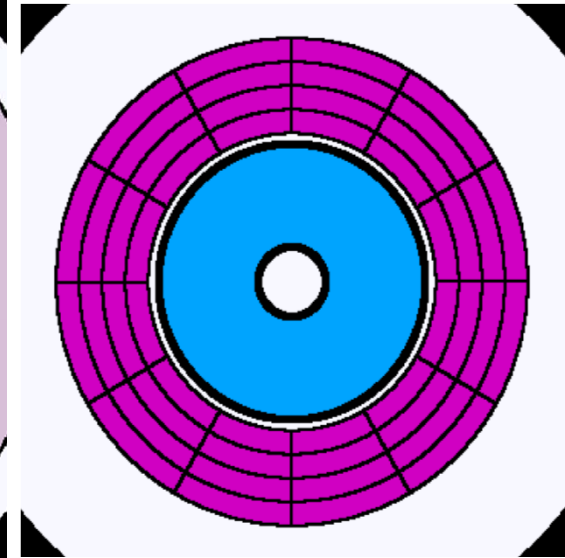

$z = 4.7$  m

MARS15 simulations (with MCNP data files) are used to suggest changes in the W-bead shielding to keep the power deposition below 0.1 mW/g in superconducting coils, as needed to provide a 10-year operation lifetime against radiation damage.

These simulations are very time consuming,  $\Rightarrow$  Run MARS at NERSC (R. Ryne).



# Energy Deposition in the Chicane

Pavel Snopok (IIT) [IPAC13, TUPFI067]

A chicane in the Decay Channel could mitigate the 500-kW power in scattered protons which otherwise would impact on the Buncher/Phase Rotator (C. Rogers).

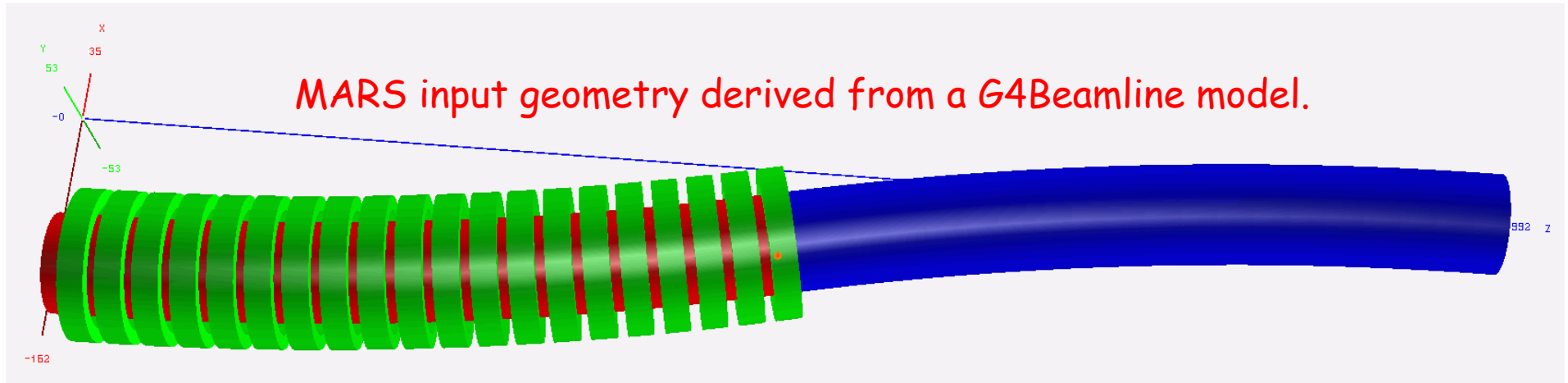

MARS15 simulations show that a 10-cm-thick sleeve of pure W helps, but the "hot spot" is still a factor of 50 too "hot."

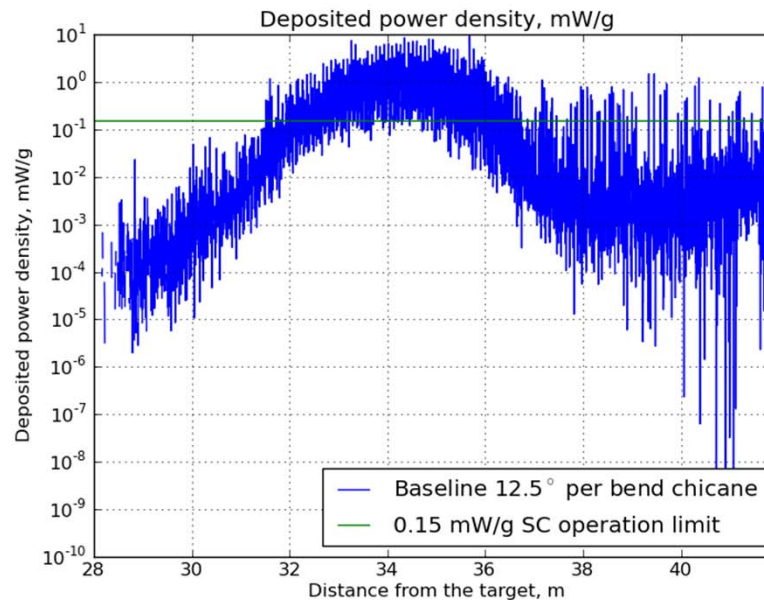
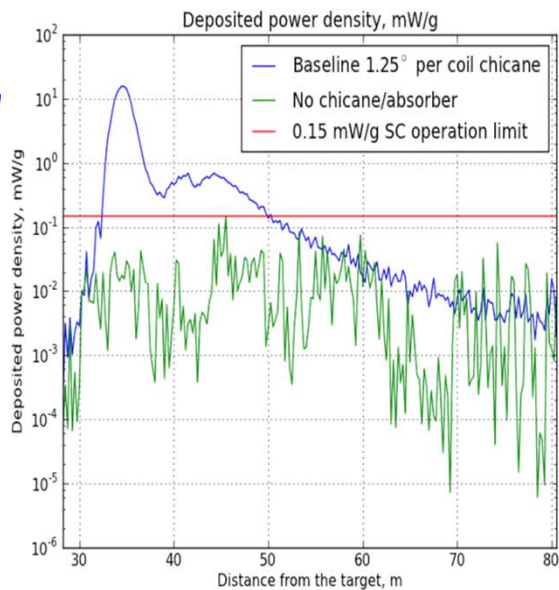

10-cm W sleeve



# Mercury Target Module Design

Van Graves (ORNL) [IPAC13, THPFI092]

Insertion/  
extraction  
of the  
Mercury  
Module:

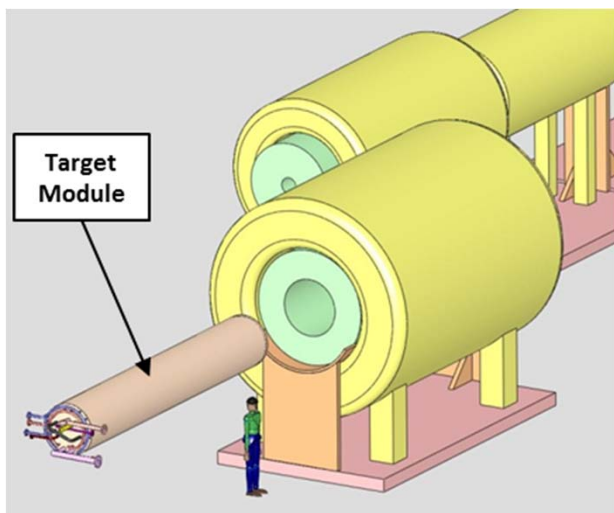

Cross  
sections  
of the  
Mercury  
Modules  
for 20 T  
and 15 T:

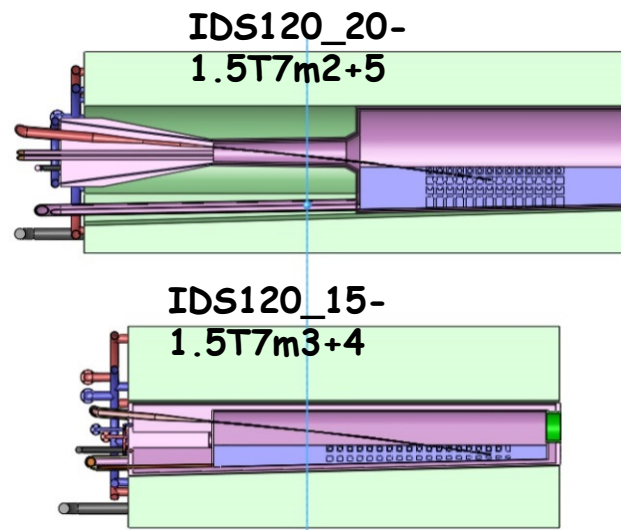

The mercury  
flow loop:

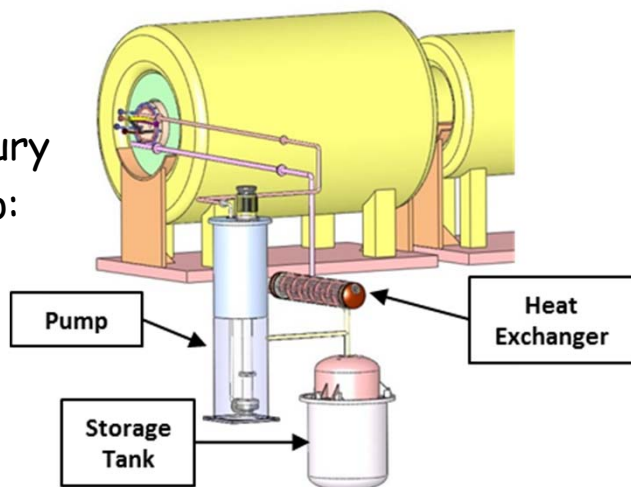

Services  
for the  
Mercury  
Module  
and the  
Shielding  
Module:

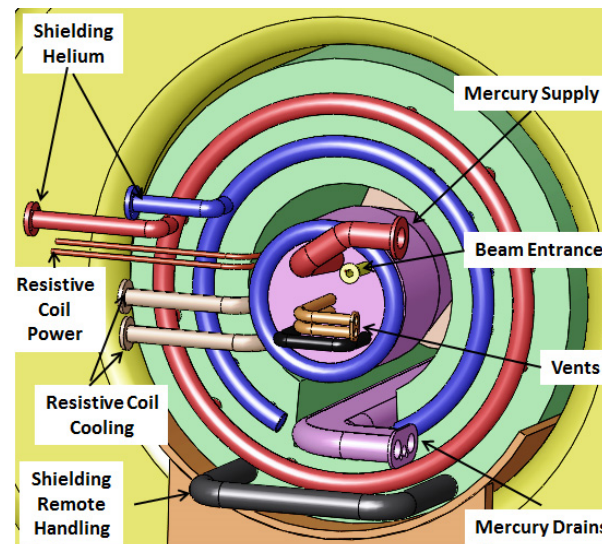

# Mercury Nozzle Simulations

Yan Zhan (SUNY Stony Brook)

MERIT mercury jet was "elliptical," possibly due to weld beads inside the Ti nozzle.

Weld Region

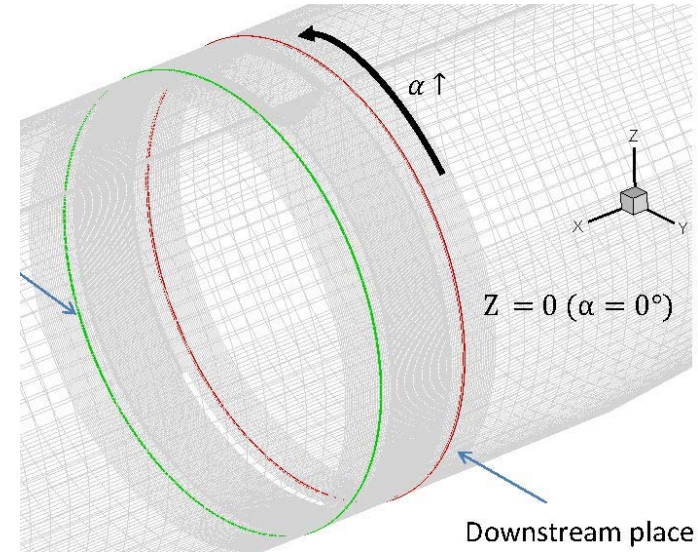
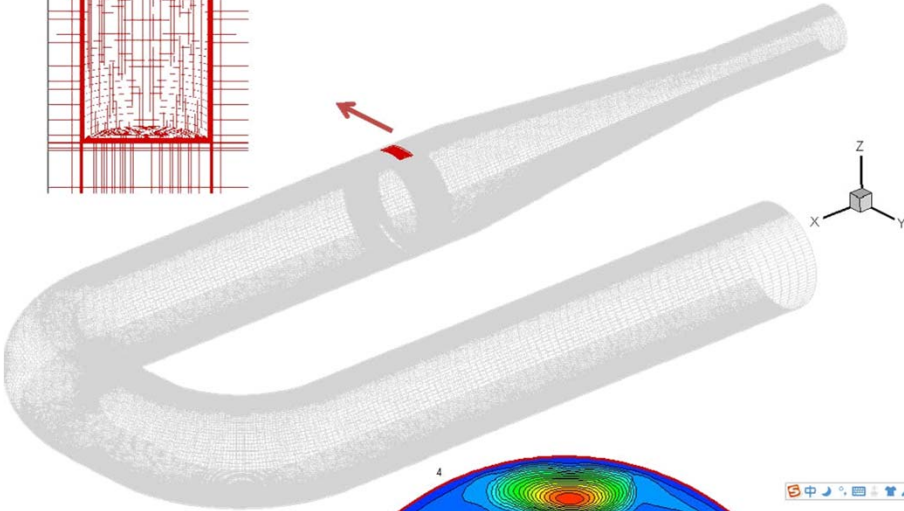
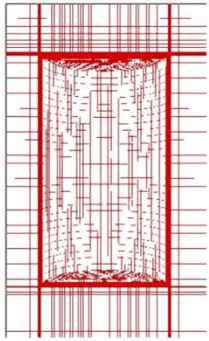

Downstream place

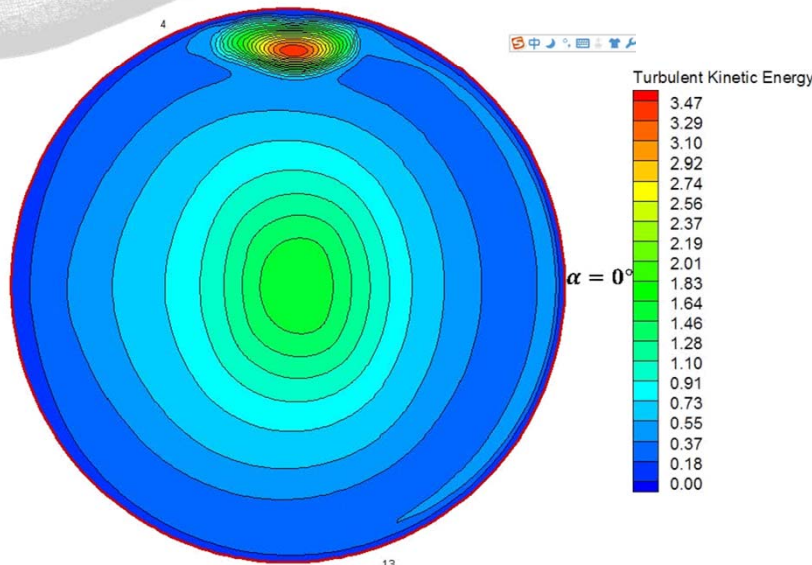

At nozzle exit:

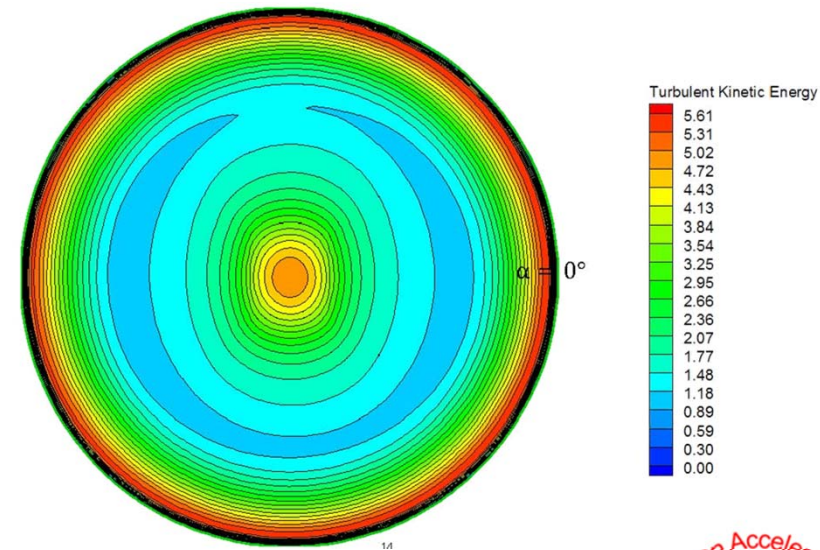

ANSYS FLUENT simulation suggests that weld-bead effect is damped at nozzle exit. Next step: model free jet outside nozzle.



# Beam-Jet Interaction Simulations

Roman Samulyak (SUNY Stony Brook)

Frontier simulation of high-speed-jet cavitation and breakup:



Smoothed-Particle-Hydrodynamics  
simulation of MERIT beam-jet interaction:

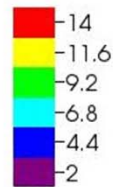
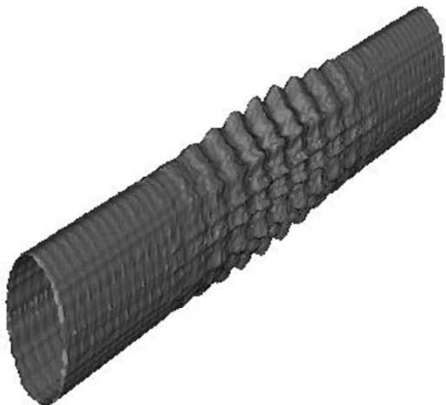

Simulation of mercury thimble experiments  
(2001) using the Lagrangian particle code:

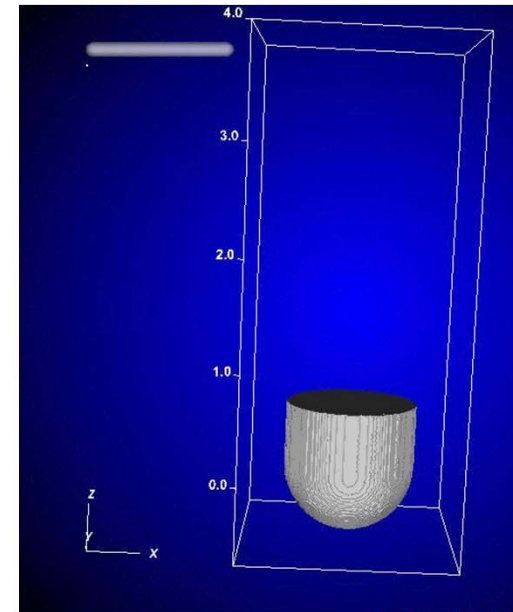



# Preliminary Costing of a 4-MW Target System

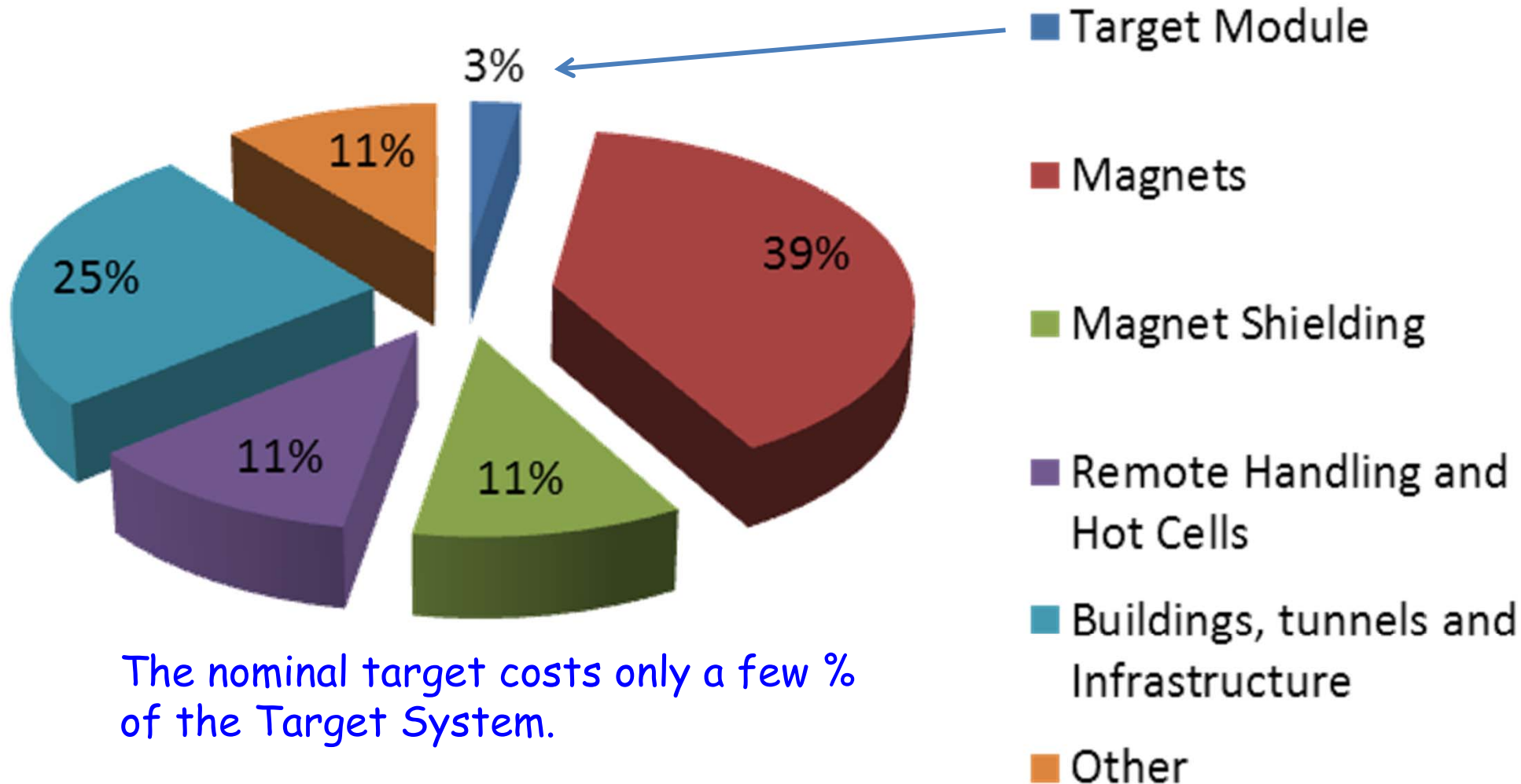

The nominal target costs only a few % of the Target System.

Infrastructure costs are ~ 50%.

(A. Kurup, International Design Study for a Neutrino Factory)



# Staging Scenarios for the Target System

---

Easy to start with a graphite target for a 1-MW proton beam power, but only saves ~3%.

Could reduce capture field from 15-20 T to ~ 5 T, but would save only 20-25% and would reduce the muon yield.

Could build target station with infrastructure only for 1-MW, which might save 20%, but no upgrade path to 4-MW (except total new build).

Could eliminate the solenoid capture scheme, and consider a toriodal horn, but operation of a horn at 50 Hz (or higher, as per J.-P. Delahaye) is beyond present technology.

Bottom line: A staging scenario for the Target System that maintains an upgrade path to 4 MW with substantial initial cost savings is challenging.

[Starting with 3 GeV rather than 8 GeV makes little difference in the cost of the Target System, but reduces performance considerably.]



# Target System Effort in FY14-15

MAP L1 Task:	Technology Development								
MAP L1 Manager:	Harold Kirk								
MAP L2 Task:	Targets and Absorbers								
MAP L2 Manager:	Kirk McDonald								
MAP L2 WBS ID:	3.04								
								Totals:	10.25
Work Package* (See Notes)	Start Date	End Date	Brief Description	Investigators (List Institution PI first)	Institution	Milestones/Deliverables		Effort (FTE-yrs)	
						Qtr	Type		
	Q1 FY14	Q4 FY15	Management of 3.04	K McDonald	Princeton		reports, PAC papers	0.4	
	Q1 FY14	Q4 FY15	Target System/Front End Global Optimization	H Kirk, H Sayed +?	BNL		reports, PAC papers	3	
	Q1 FY14	Q4 FY15	Energy deposition simulations	J Kolonko, N SouchalsPBL			reports, PAC papers	1.5	
	Q1 FY14	Q4 FY15	Magnet design (conceptual)	J Kolonkn, R Weggel	PBL		reports, PAC papers	1.1	
	Q1 FY14	Q4 FY15	Beam/Target optimization	D Cline, X Ding	UCLA		reports, PAC papers	0.75	
	Q1 FY14	Q4 FY15	Mercury handling system design	V Graves	ORNL		drawings, reports, PAC papers	0.5	
	Q1 FY14	Q4 FY15	Beam/jet interaction simulations	R Samulyak	SUNY Stony Brook		PhD thesis, paper	2	
	Q1 FY14	Q4 FY15	Nozzle/jet simulations	F Ladience, Y Zhan	SUNY Stony Brook		PhD thesis, paper	1	

