

Targetry Issues at a Muon Collider

[<http://www.hep.princeton.edu/~mcdonald/mumu>]

K.T. McDonald

Princeton U.

March, 19, 1998

Muon Collider Collaboration Meeting

Orange Beach, Alabama

Overview of Targetry for a Muon Collider

- Get muons from pion decay: $\pi^\pm \rightarrow \mu^\pm \nu$.
- Pions from proton-nucleus interactions in a **target**.
- Goal: $1.2 \times 10^{14} \mu^\pm/\text{s}$.
- \Rightarrow High- Z target,
High-energy proton beam,
High magnetic field around target to capture soft pions.
- $\mu/p = 0.08$ at 16 GeV $\Rightarrow 1.5 \times 10^{15} p/\text{s}$.
- 15-Hz proton source.
- 4 MW power in p beam.
- Compare: 0.1 MW in 900-GeV extracted p beam at FNAL;
0.25 MW in 30-GeV extracted beam at BNL AGS.

Baseline Scenario

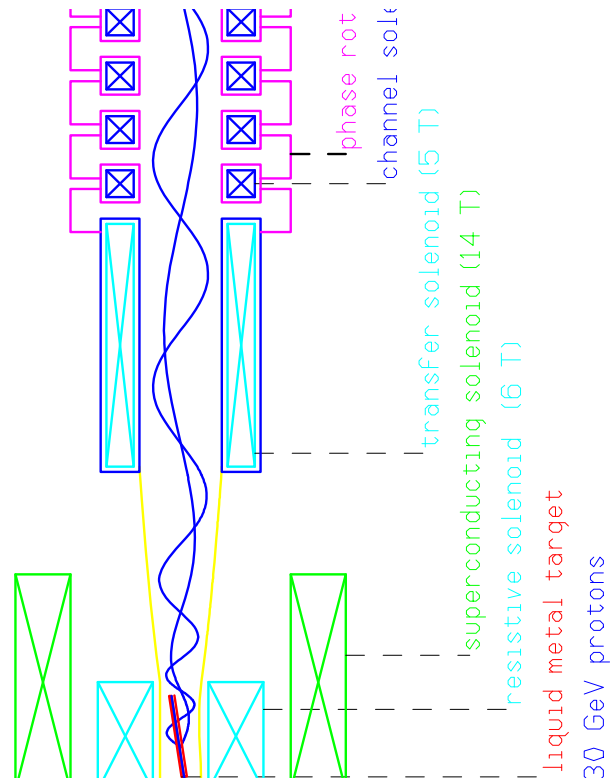

- Liquid metal target: Ga, Hg, or solder (Bi/In/Pb/Sn alloy)
- 20-T capture solenoid followed by 5-T phase-rotation channel.
- 20 T = 8-T, 8-MW water-cooled Cu magnet
+ 12-T superconducting magnet.
- Cost of 12-T magnet $\approx 0.8 \text{ M\$ } (B[\text{T}] R[\text{m}])^{1.32} (L[\text{m}])^{0.66}$
 $\approx \$6\text{M}$.

- Capture pions with $P_{\perp} < 220 \text{ MeV}/c$.
- Adiabatic invariant: $\Phi = \pi r^2 B$ as B drops from 20 to 5 T.
- $r = P_{\perp}/eB =$ radius of helix.
- $\Rightarrow P_{\perp,f} = P_{\perp,i} \sqrt{B_f/B_i} = 0.5$ (and $P_{\parallel,f} > P_{\parallel,i}$).
- Tilt target by ≈ 0.1 rad to minimize absorption of spiralling pions (factor of 2 effect).
- Target should be short and narrow,
 \Rightarrow high density; no cooling jacket.
- High power of beam would crack stationary target.
- \Rightarrow **Pulsed heavy-metal liquid jet** as target.

Targetry Workshop, Princeton U., Feb. 28, 1998

- B. Palmer: Requirements for Targetry at a Muon Collider.
- C. Johnson: Experience with High Flux Targets.
- D. Smith: The Argonne Liquid Metal Program.
- J. Hastings: The AGS Spallation Target Experiment.
- B. Weggel: Motion of Conductors in Magnetic Fields.
- K. McDonald: Options for Liquid Jets.
- C. Lu: ANSYS Simulations of Eddy Current Effects.
- B. King: Slab Geometry (Bandsaw) Target.
- D. Summers: Target Materials.
- B. Weggel: High Field Magnets for the Primary Target Region.
- E. Prebys: The Princeton Superconducting Magnet.
- H. Kirk: Laser Compressed Targets.
- + J. Gallardo, Y. Torun and S. Vahsen.

Colin Johnson: The Voice of Experience

- See, *Hyperfine Interactions* **44**, 21 (1988).
- High-power pulsed beams crack solid targets.
- Try a mercury jet:

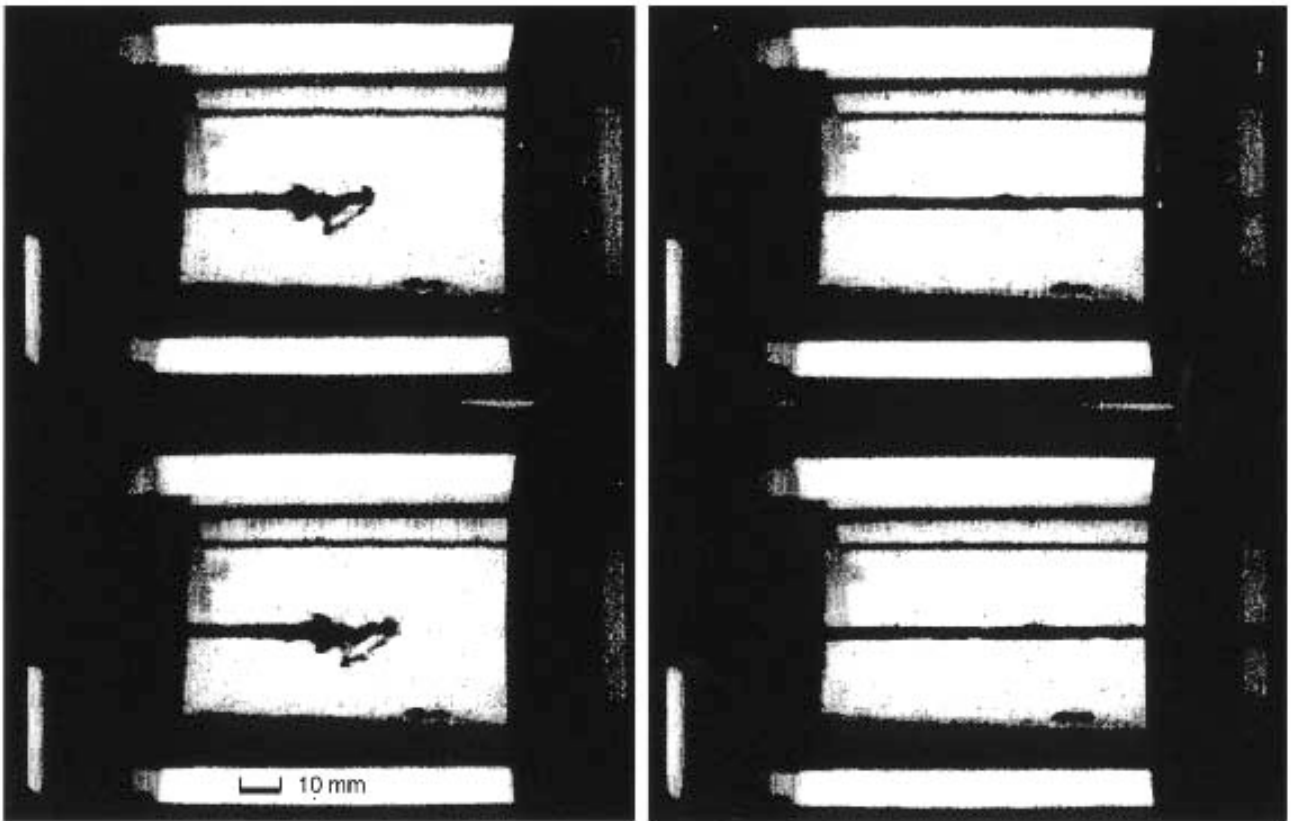

High-speed photographs of mercury jet target for CERN-PS-AA. (laboratory test)
4,000 frames per second, Jet speed: 20 ms^{-1} , diameter: 3 mm, Reynold's Number: $>100,000$
A. Poncelet

- Try tungsten powder.

- 4 MW beam power \Rightarrow lots of radiation:

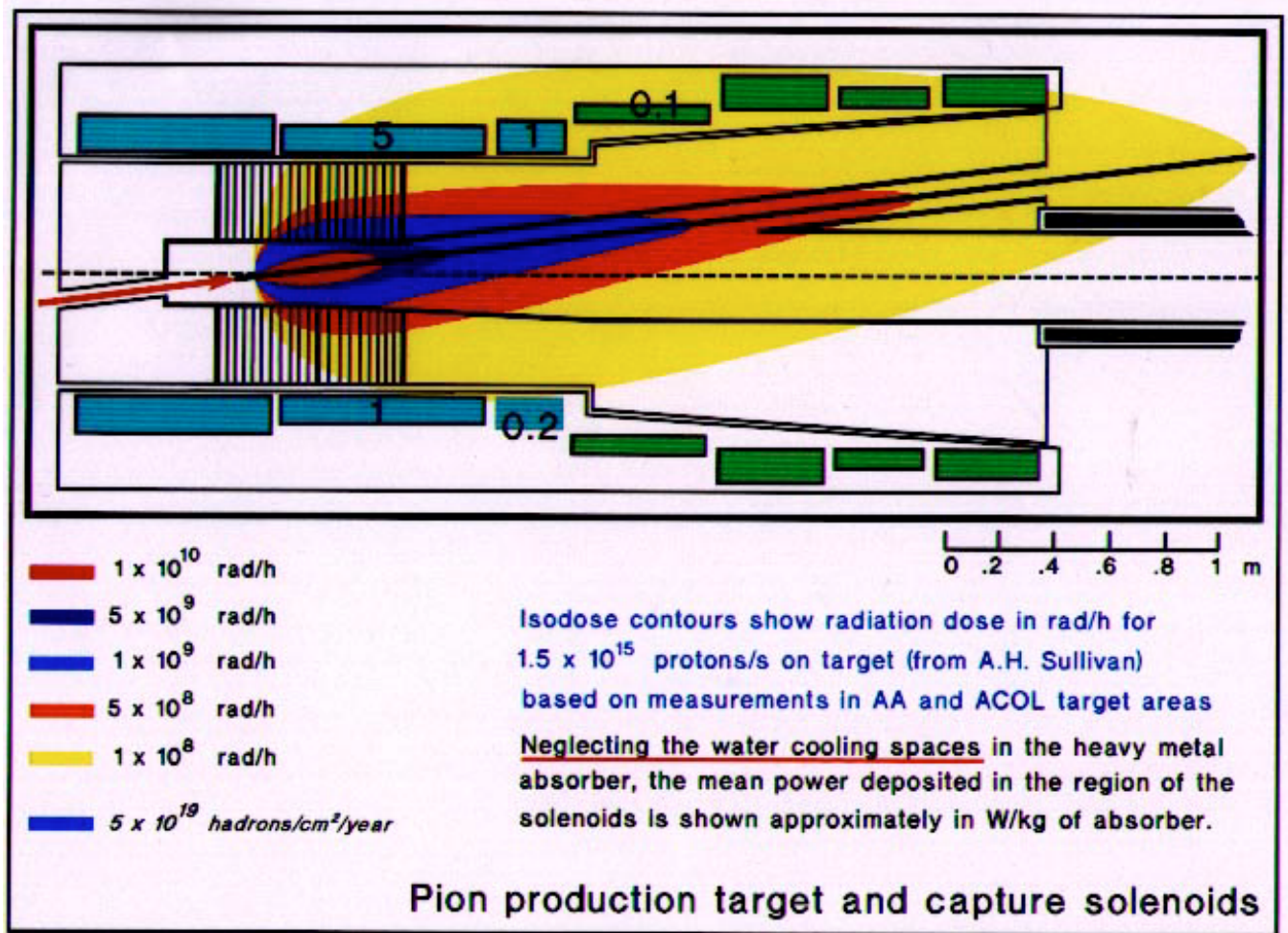

- 30 people worked on the AA/ACOL target.

J. Hastings: A Hg Target for a Spallation Source

- Beam tests with a 1-m-long tank of Hg:

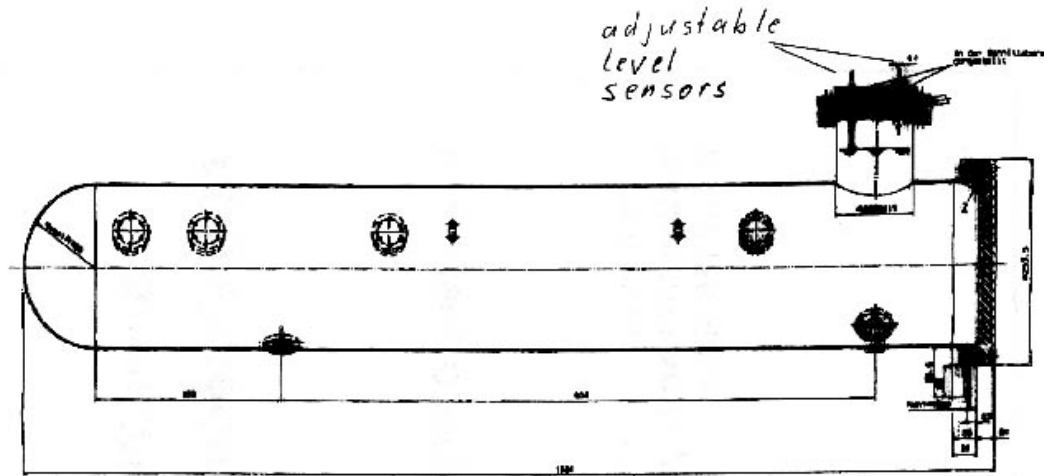

- Reasonable agreement with Monte Carlo:

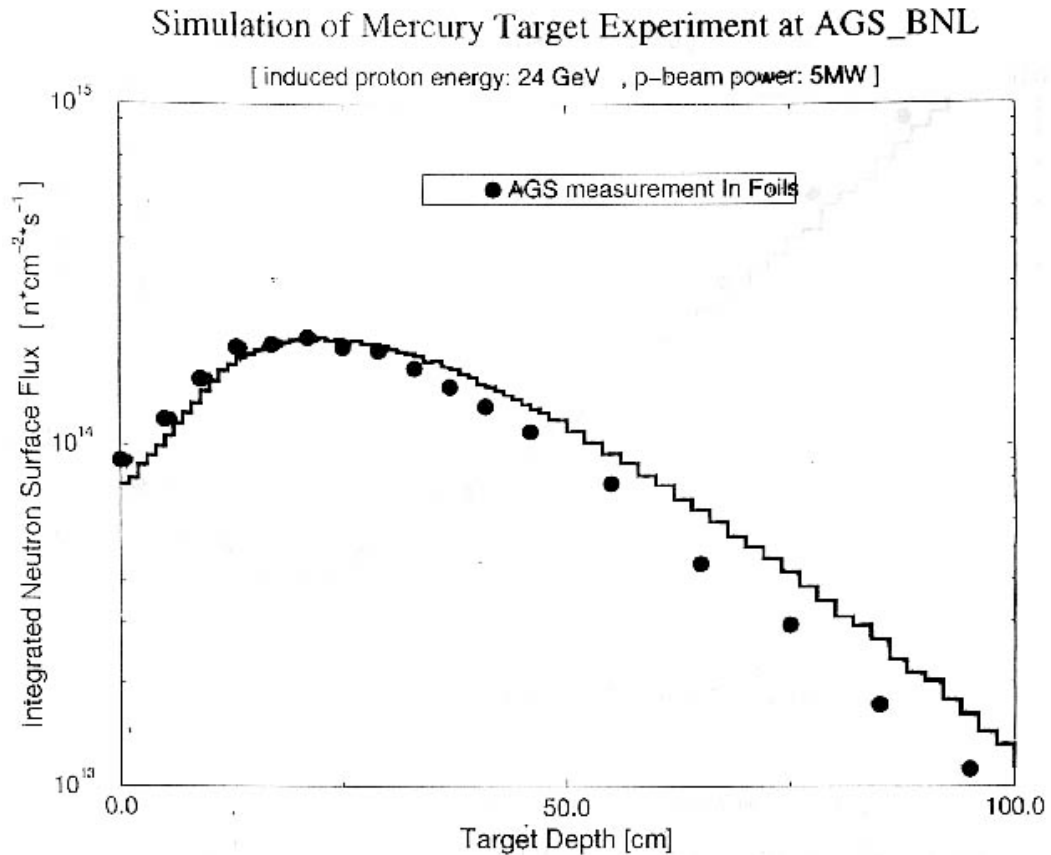

D. Smith: ANL Liquid Metal Program

ALEX FACILITY

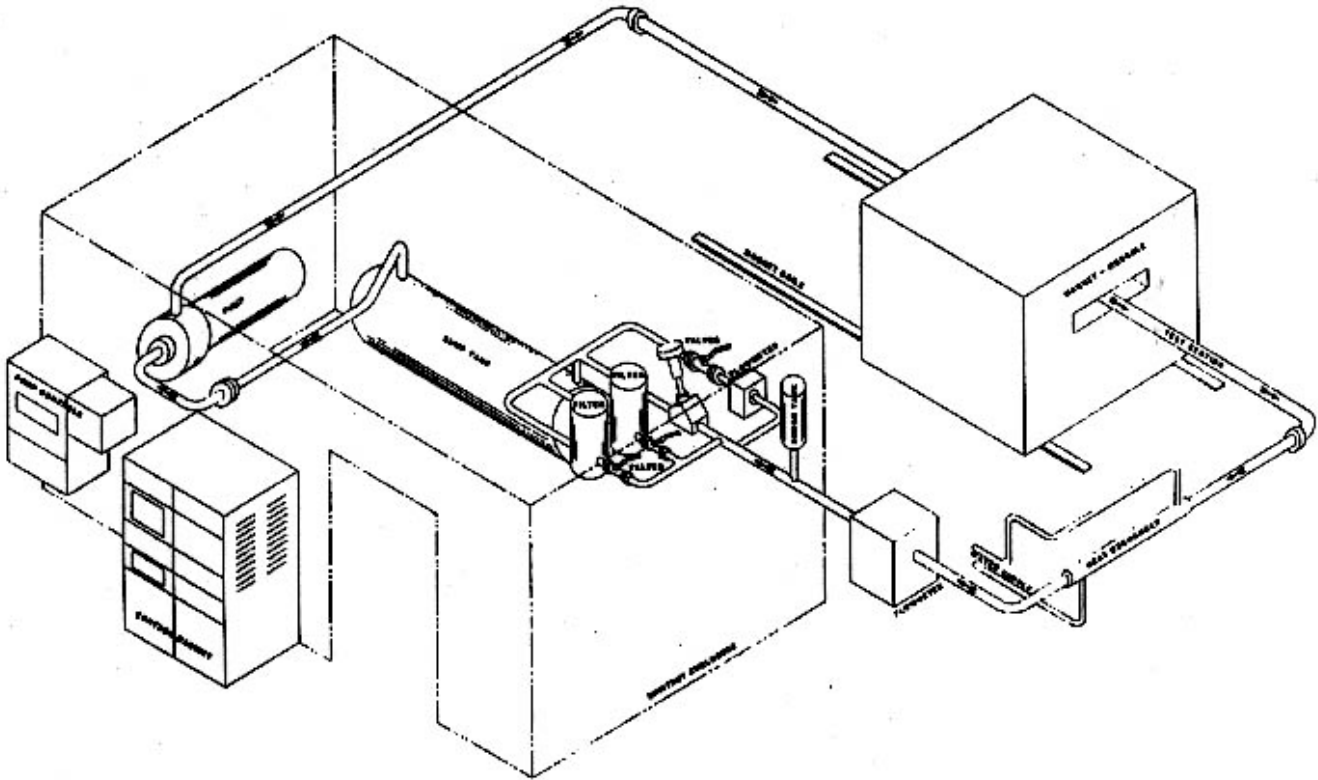

Possibility to collaborate on muon collider R&D.

K. McDonald, B. Weggel: Forces on Liquid Jets

Preprints: Princeton/ $\mu\mu$ /97-3, and notes by Weggel.

Gravity:

- Sagitta of parabola at peak: $h = gl^2/8v^2$.
- $\Rightarrow v > 10$ m/s for $h < 1/8$ cm and $l = 30$ cm.
- (Distinct 30-cm-long pulses at 15-Hz rep rate $\Rightarrow v > 5$ m/s.)

Eddy Currents in conducting Liquids:

- In frame of jet, changing magnetic field induces eddy currents.
- Lenz: Forces on eddy current oppose motion of jet.
- Longitudinal drag force \Rightarrow won't penetrate magnet unless jet has a minimum velocity: $\sigma = \sigma_{\text{Cu}}/60$, $\rho = 10$ g/cm³, \Rightarrow

$$v_{\min} > 60 \text{ m/s} \left[\frac{r}{1 \text{ cm}} \right] \left[\frac{r}{D} \right] \left[\frac{B_0}{20 \text{ T}} \right]^2.$$

Ex: $B_0 = 20$ T, $r = 1$ cm, $D = 20$ cm, $\Rightarrow v_{\min} = 3$ m/s.

- Drag force is larger at larger radius \Rightarrow planes deform into cones:

$$\frac{\Delta z(r)}{r} \approx -3\alpha \left[\frac{r}{1 \text{ cm}} \right] \left[\frac{B_0}{20 \text{ T}} \right]^2 \left[\frac{10 \text{ m/s}}{v} \right].$$

Ex: $\alpha = L/D = 2$, $r = 1 \text{ cm}$, $v = 10 \text{ m/s} \Rightarrow \Delta z = 6 \text{ cm}$.

- Radial pressure: compression as jet enters magnet, expansion as it leaves:

$$P \approx 50 \text{ atm.} \left[\frac{r}{1 \text{ cm}} \right] \left[\frac{r}{D} \right] \left[\frac{B_0}{20 \text{ T}} \right]^2 \left[\frac{v}{10 \text{ m/s}} \right].$$

Ex: $P = 2.5 \text{ atm}$ for previous parameters.

- Will the jet break up into droplets?

- Jet at angle θ to magnet axis \Rightarrow transverse drag.

But, $\Delta v_x = \Delta v_z/8$.

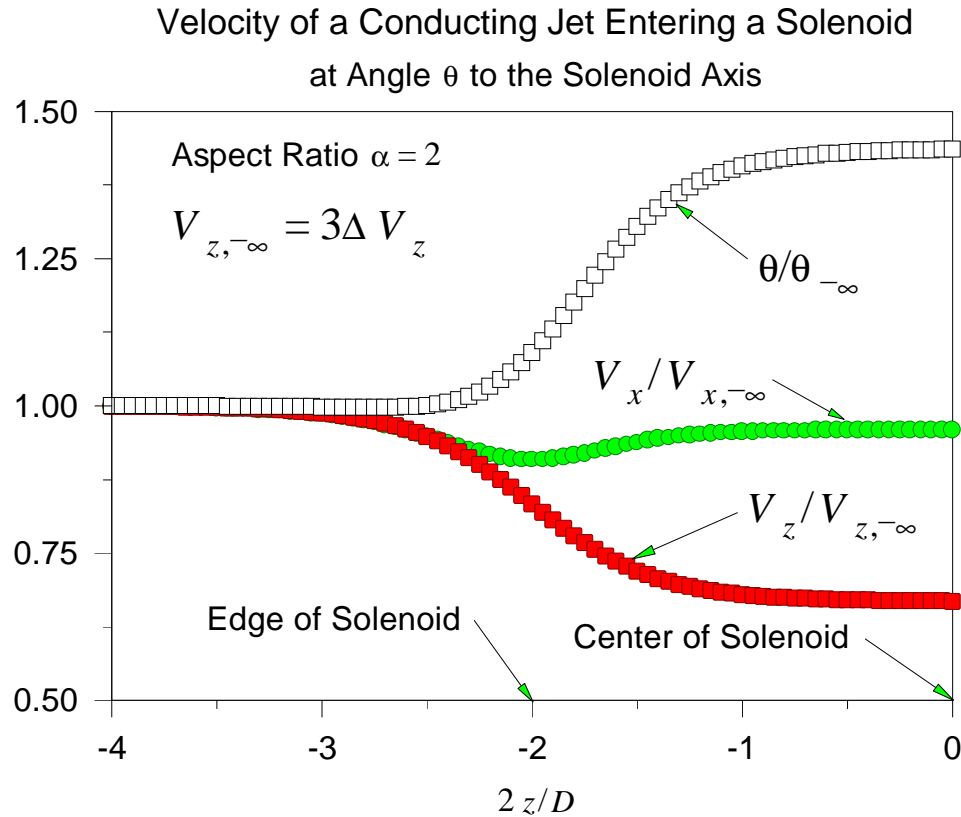

$\Rightarrow \theta$ increases as jet enters magnet.

Ex: $\alpha = 2, v = 3\Delta v_z \Rightarrow \theta_{\text{in}} = 1.5\theta_{\text{out}}$.

- Drag and shear are smaller for larger initial velocity, but pressure rises with velocity.
- Is there a safe working regime?
- Need both FEA analysis and **lab tests**.

C. Lu: ANSYS Simulations

Remote use of a BNL seat; EMAG only.

Now studying eddy currents in solid spheres:

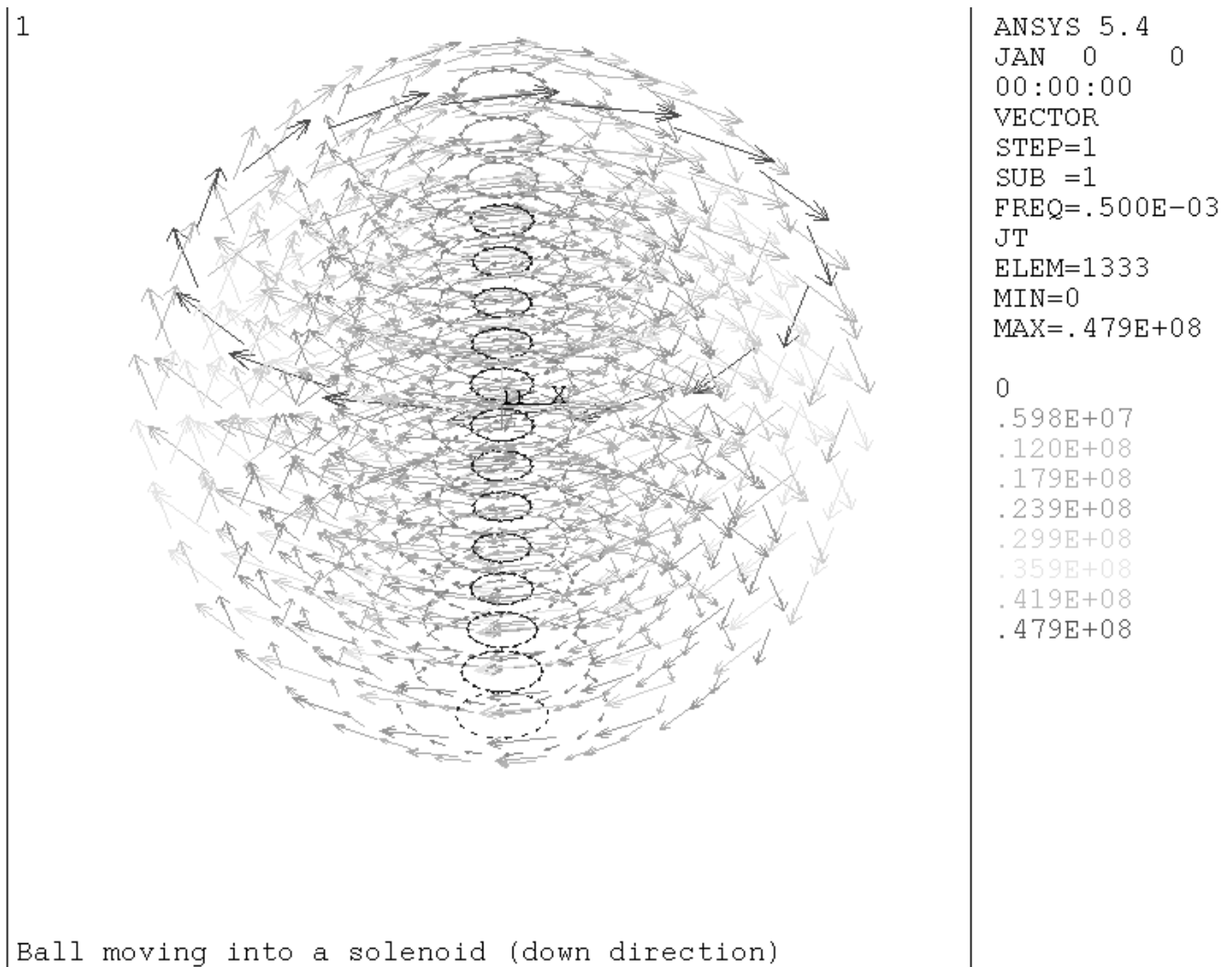

Will add fluid dynamics (FLOTRAN) in near future.

Additional simulations welcome!

B. Weggel: Survey of Magnets for R&D

Magnets will dominate cost of targetry R&D.

Good option is 8-T, 8-MW water-cooled Cu magnet with 6" bore.

Now at MIT magnet lab, but could borrow.

8-MW power supply and 500 gpm cooling water available at Princeton Plasma Physics Lab (pbonanos@pppl.gov).

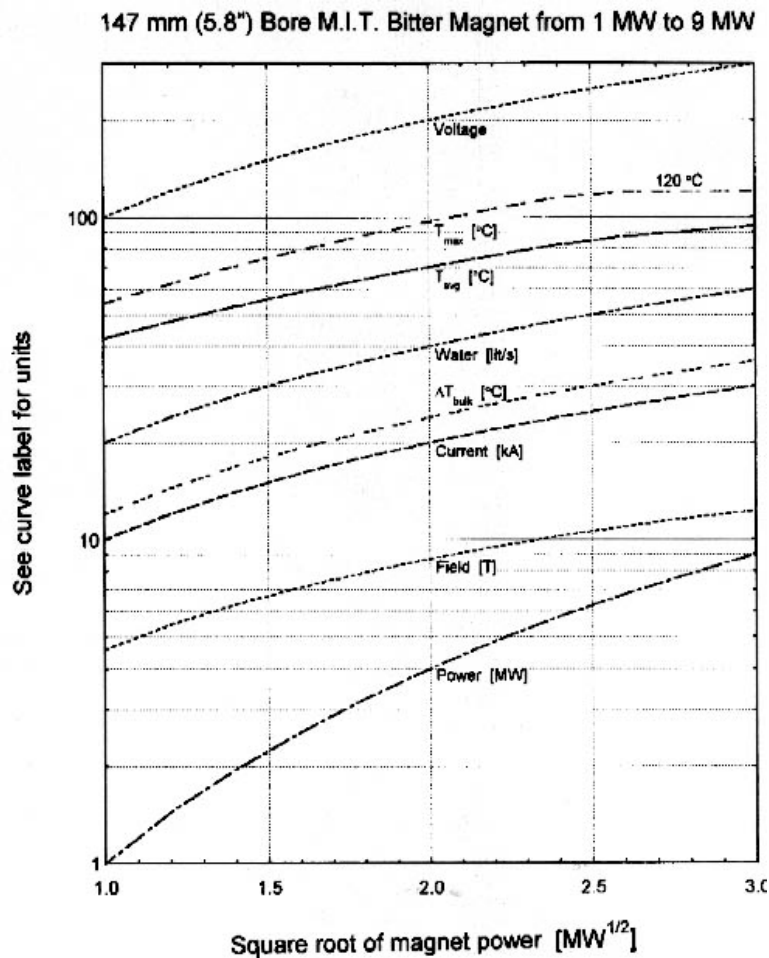

E. Prebys: Princeton Superconducting Magnet

Preprint: Princeton/ $\mu\mu$ /98-9.

We have recomissioned an 8-T magnet: 3-cm-diameter warm bore, 10-cm-long uniform field region.

Can use for initial liquid jet study, and for prototype low-pressure TPC.

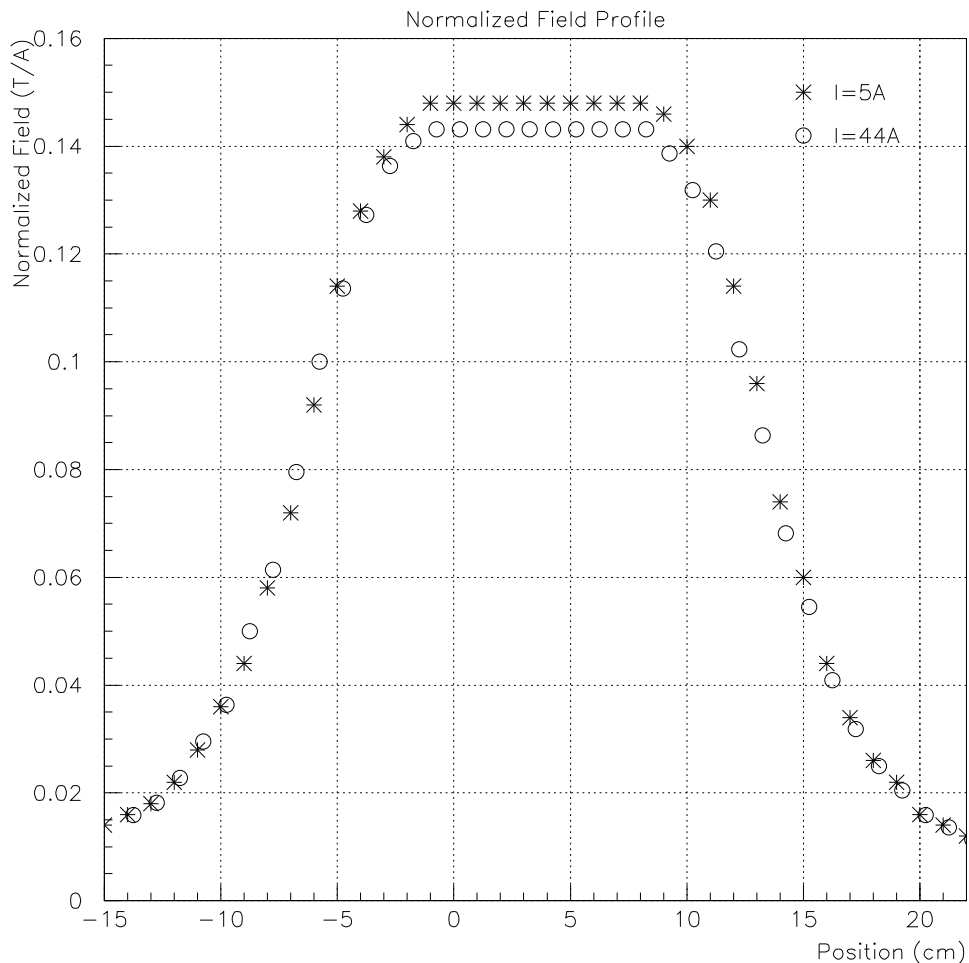

D. Summers: Survey of Liquids

LIQUID TARGET MATERIALS

Material	Density g/cc	Melting Point	Boiling Point	Resistivity uOHM-cm Solid	Liquid
100Xe	3.52	-112c	-108c	insulator	insulator
100Hg	13.55	-39c	357c	22 @ -40c	91 @ -38c
100Ga	5.90	30c	2204c	15 @ 29c	26 @ 31c
49Bi 21In 18Pb 12Sn	9.01	58c			
52Bi 32Pb 16Sn	9.71	95c			
52In 48Sn	7.30	118c		15	
100In	7.31	157c	2072c	8	
63Sn 37Pb	8.40	183c			
100Sn	7.3	232c	2270c	11	
90Pb 10Sb	10.80	260c		27	
100Bi	9.75	271c	1560c	107	129
80Au 20Sn	14.51	280c			
100Pb	11.35	327c	1747c	21 @ 20c	98 @ 340c
PtO2	10.2	450c		insulator	insulator

PtO₂ is a dielectric.

K. McDonald: Studies of Flowing Tungsten Powder

40- μm (325 mesh) tungsten powder flows well:

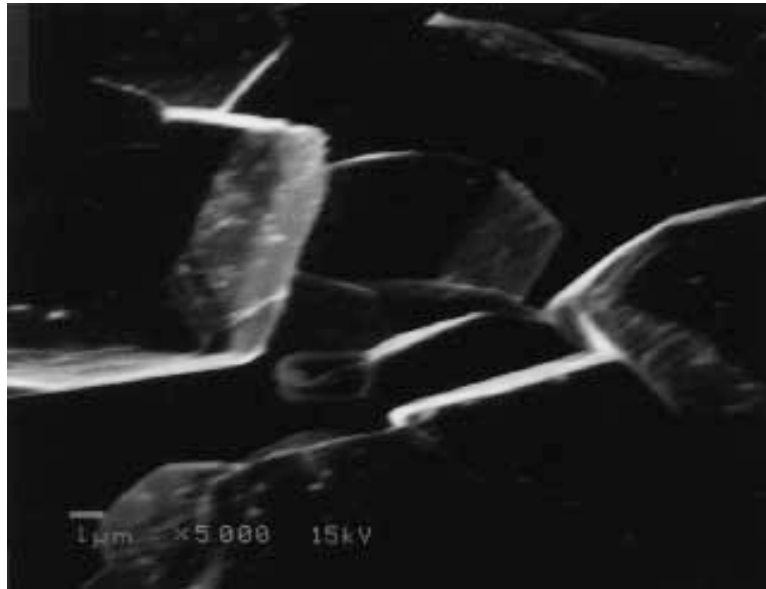

1- μm powder agglomerates and doesn't flow well:

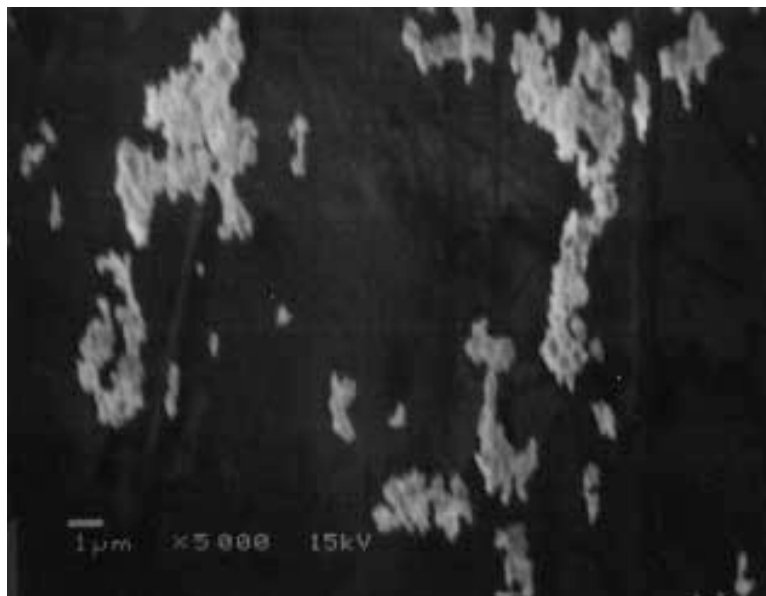

325-mesh W powder flows well vertically:

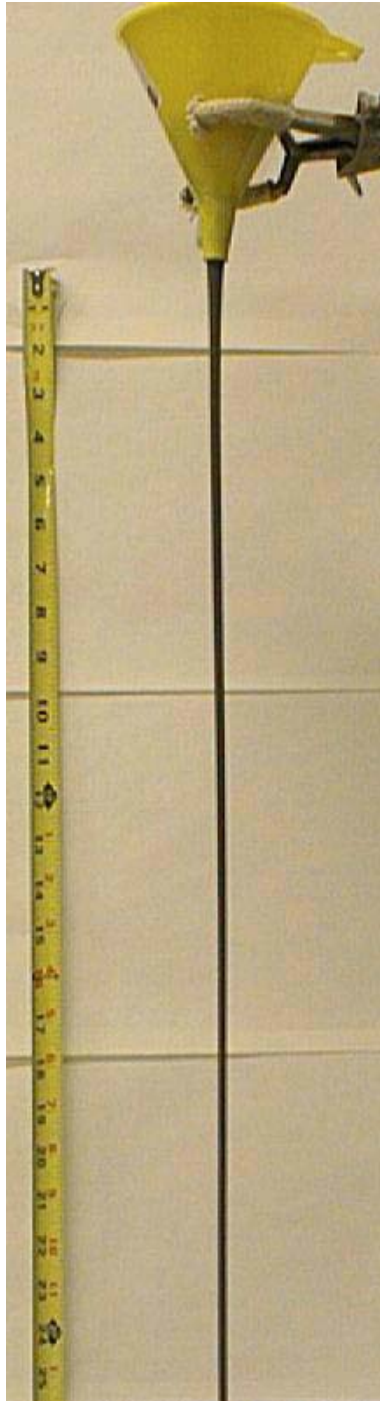

But density is only 0.3 g/cm^3 in the jet.

Bulk powder density is 8 g/cm^3 .

325 mesh flows around a 90° bend:



But loses 95% of kinetic energy to friction.

Preprint: Princeton/ $\mu\mu$ /98-10.

Still, amazing things can be done with powder:

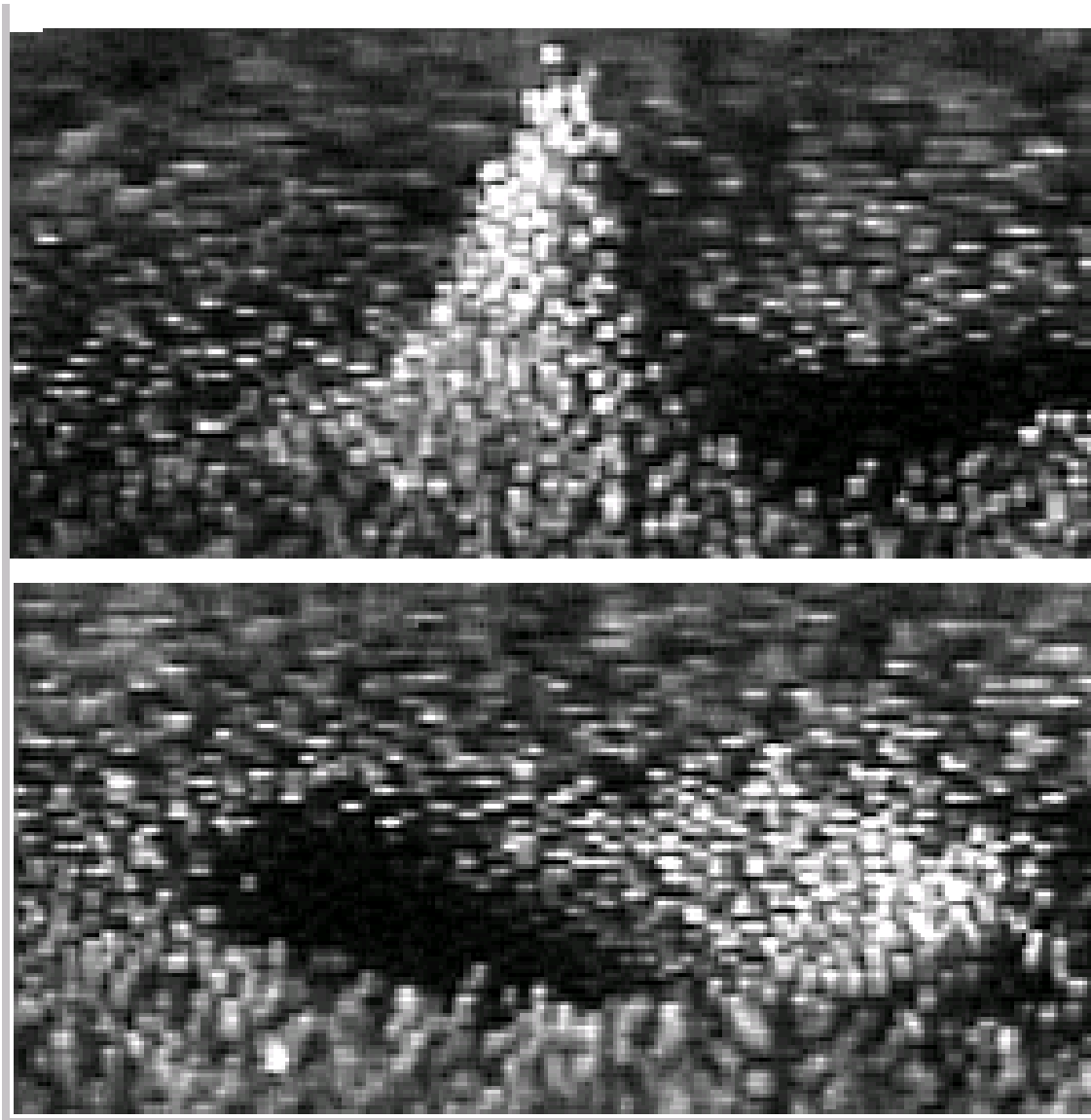

Periodic structures obtained on shaking a pan of sand in vacuum;
H.L. Swinney *et al.*, Nature **352**, 610 (1996).

B. King: “Bandsaw” Target

Cu-Ni band, 30-cm deep, rotates so that only about 5 pulses overlap.

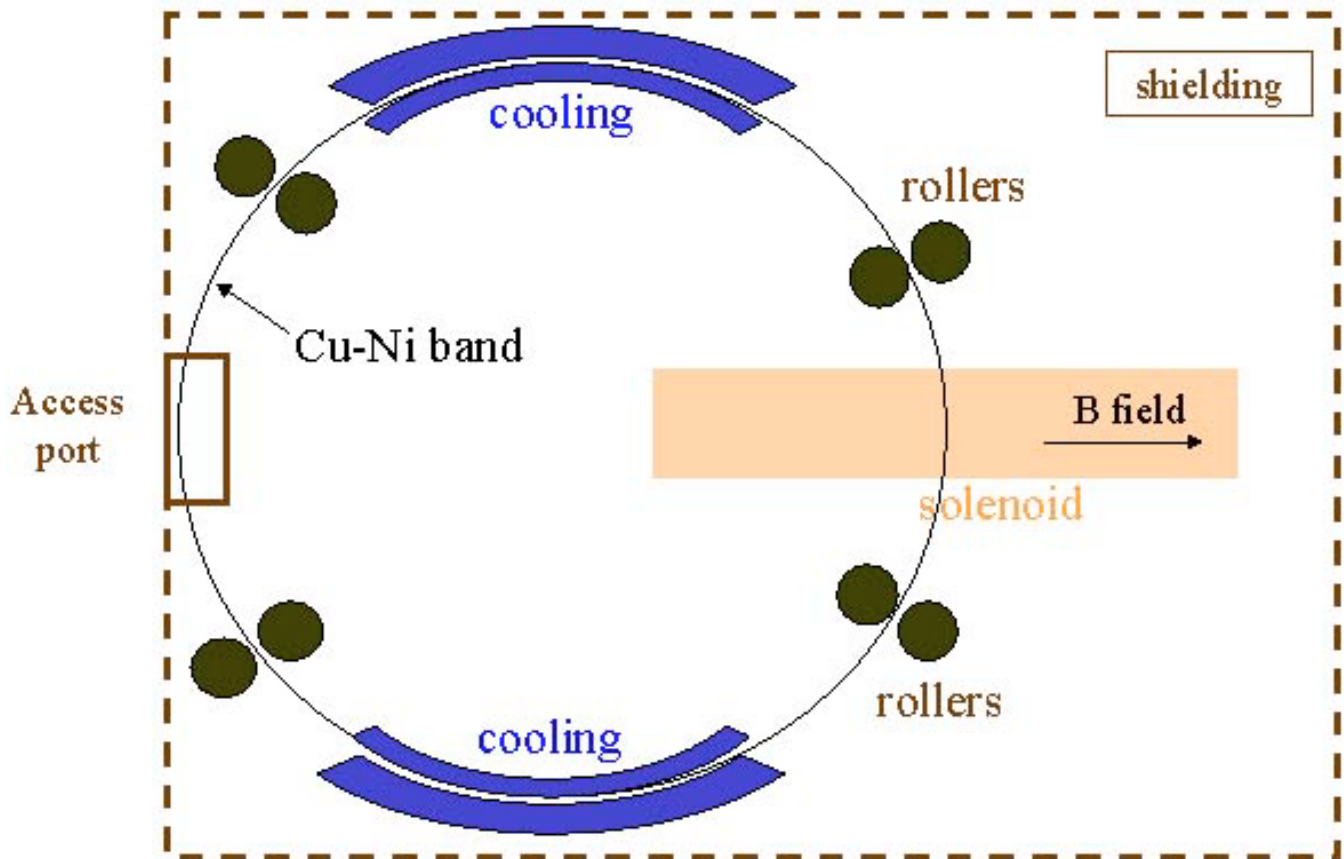

Proton beam is perp to 20-T magnet \Rightarrow must be conventional to survive radiation dose.

T.A. Vsevolozhskaya: Beam Sweeping

- Preprint: Budker INP 96-80.
- Analytic study of possibility of avoiding damage to a target by ‘sweeping’ the beam – or moving the target.
- Conclusion: It doesn’t help to have a moving solid target unless the target velocity exceeds the speed of sound.
- Possible exception: Tungsten.

Targetry Workshop Summary

- Baseline of liquid metal jet is still best bet – but needs validation via simulation and experimentation.
- Backups: liquid dielectrics, metal powders, bandsaw geometry.
- Availability of magnets will set path of R&D.
- Should expand targetry collaboration: Argonne, CERN....
- Prepare R&D proposal including beam tests.
- Goals:
 1. Proof of principal of a conducting liquid jet in a high magnetic field within 1 year.
 2. Beam test of liquid target + magnet within 2 years.
- Next targetry workshop: Friday, May 1, 1998 at BNL.