

OPTIMIZED SOLENOID BASED CAPTURE MECHANISM FOR A MUON COLLIDER/NEUTRINO FACTORY TARGET SYSTEM

HISHAM KAMAL SAYED
BROOKHAVEN NATIONAL LABORATORY

MAP COLLABORATION MEETING, FERMILAB, June 20 2013



INTRODUCTION & LAYOUT

Muon Capture in Target & Front END

- Capture Solenoid Field Study:
 - Optimizing quantity: Muon (Pions) count – transverse capture
 - Target Solenoid peak field
 - Final end field
 - Optimizing quality: Muon (Pions) longitudinal phase space (transverse-longitudinal coupling) – transverse-longitudinal capture
 - Taper field profile
- Optimizing the time of flight of incident beam (Buncher-Rotator RF phase)
- Transverse focusing field in decay-channel-buncher-rotator
- Match to ionization cooling channel for every end field case 1.5 T → 3.5 T
- Performance of front end as a function of proton bunch length
- Realistic Coil Design & performance optimization

MUON COLLIDER/NEUTRINO FACTORY LAYOUT

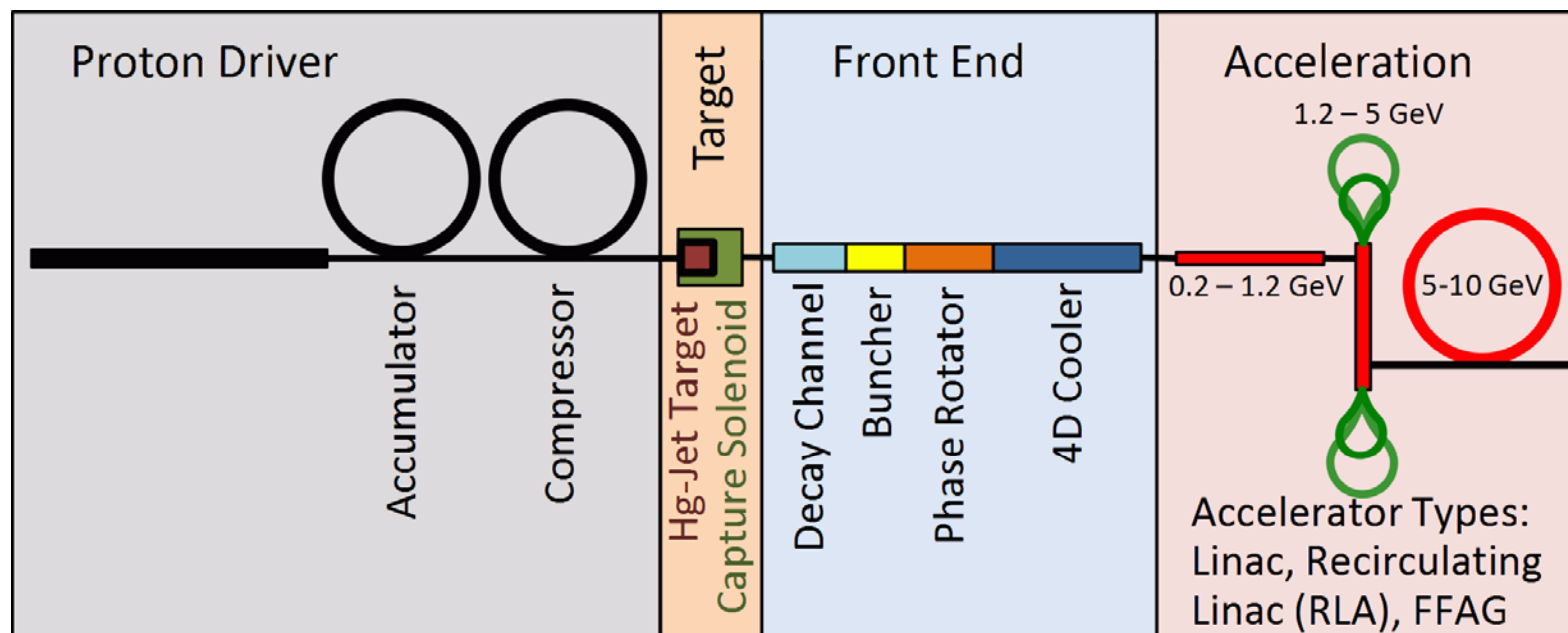

Target System Solenoid:

Capture μ^\pm of energies $\sim 100\text{-}400$ MeV from a 4-MW proton beam ($E \sim 8$ GeV).

TARGET SYSTEM CURRENT BASELINE DESIGN

- Production of 10^{14} μ/s from 10^{15} p/s (≈ 4 MW proton beam)
- Proton beam readily tilted with respect to magnetic axis.
- Shielding of the superconducting magnets from radiation is a major issue.
- Hg Target
- Proton Beam
 - $E=8$ GeV
- Solenoid Field
 - IDS120h \rightarrow 20 T peak field at target position ($Z=-37.5$)
 - Aperture at Target $R=7.5$ cm - End aperture $R = 30$ cm
 - Fixed Field $Z = 15$ m $\rightarrow B_z=1.5$ T

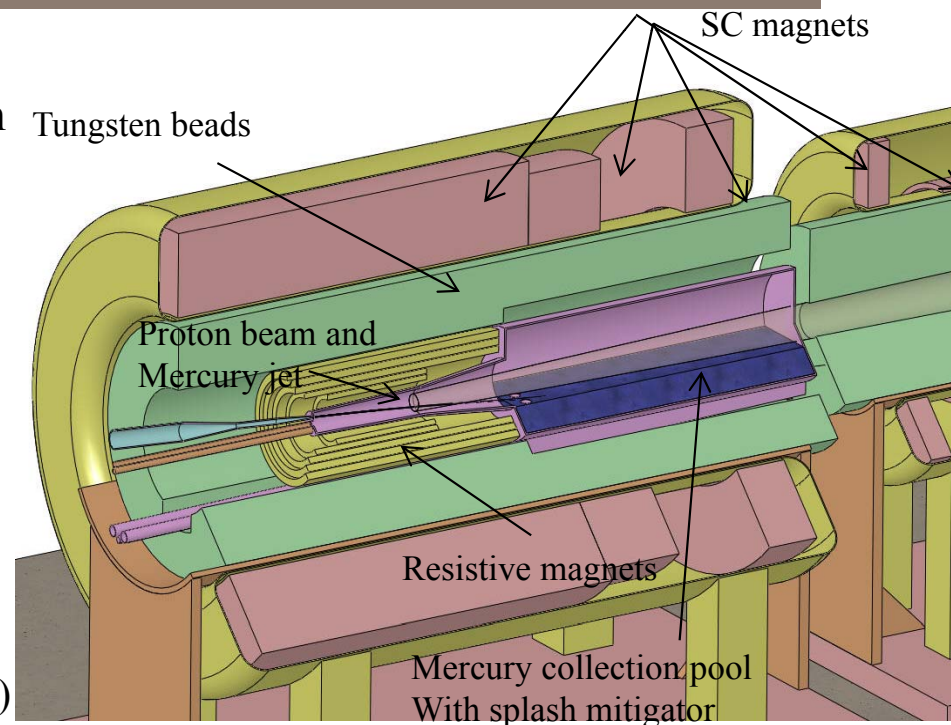

5-T copper magnet insert; 10-T Nb₃Sn coil + 5-T NbTi outsert.
Desirable to eliminate the copper magnet (or replace by a 20-T HTS insert).

- Production: Muons within energy KE cut 40-180 MeV end of decay channel

$$\text{➤ } N_{\mu+\pi+\kappa}/N_P=0.3-0.4$$

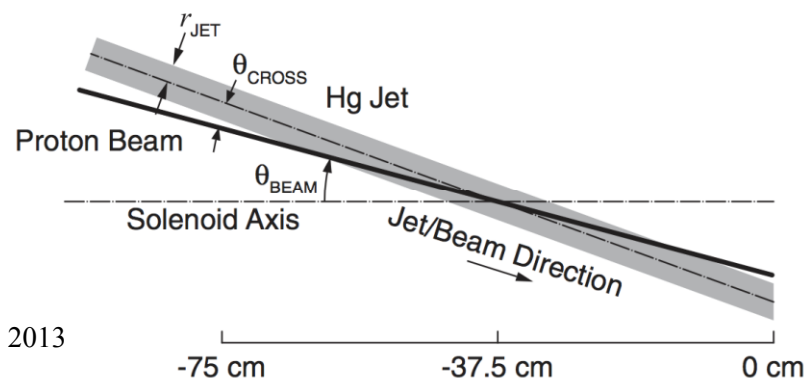

TAPERED TARGET SOLENOID OPTIMIZATION

Inverse-Cubic Taper

$$B_z(0, z_i < z < z_f) = \frac{B_1}{[1 + a_1(z - z_1) + a_2(z - z_1)^2 + a_3(z - z_1)^3]^p}$$

$$a_1 = -\frac{B_1'}{pB_1} \quad a_2 = 3\frac{(B_1/B_2)^{1/p} - 1}{(z_2 - z_1)^2} - \frac{2a_1}{z_2 - z_1} \quad a_3 = -2\frac{(B_1/B_2)^{1/p} - 1}{(z_2 - z_1)^3} + \frac{a_1}{(z_2 - z_1)^2}$$

Off-axis field approximation

$$B_r(r, z) = \sum_n (-1)^{n+1} \frac{a_0^{(2n+1)}(z)}{(n+1)(n!)^2} \left(\frac{r}{2}\right)^{2n+1}$$

$$B_z(r, z) = \sum_n (-1)^n \frac{a_0^{(2n)}(z)}{(n!)^2} \left(\frac{r}{2}\right)^{2n}$$

$$a_0^{(n)} = \frac{d^n a_0}{dz^n} = \frac{d^n B_z(0, z)}{dz^n}$$

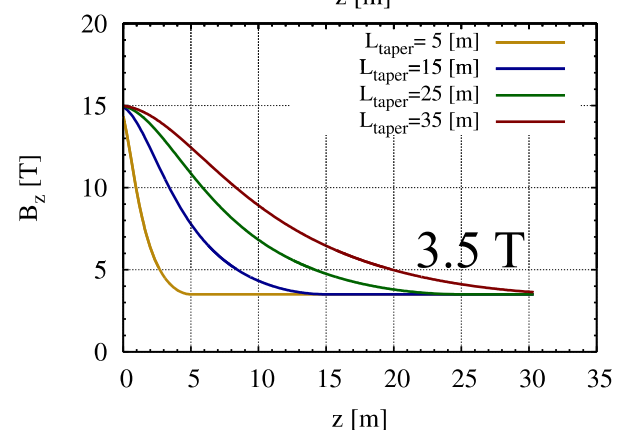
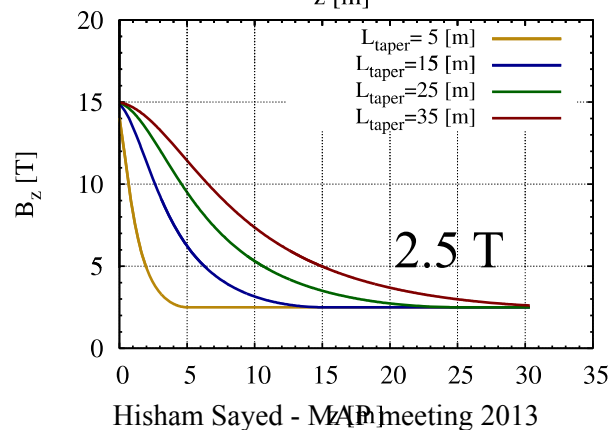
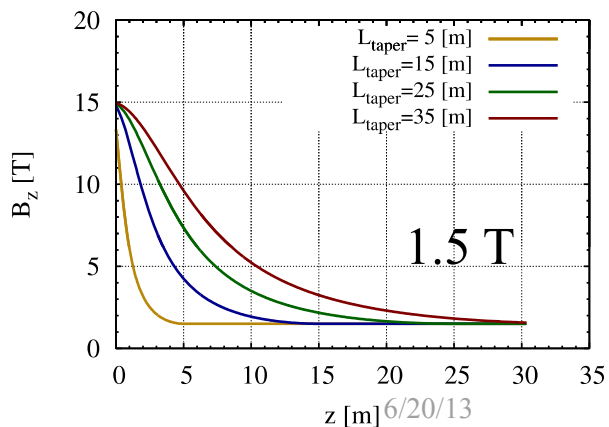
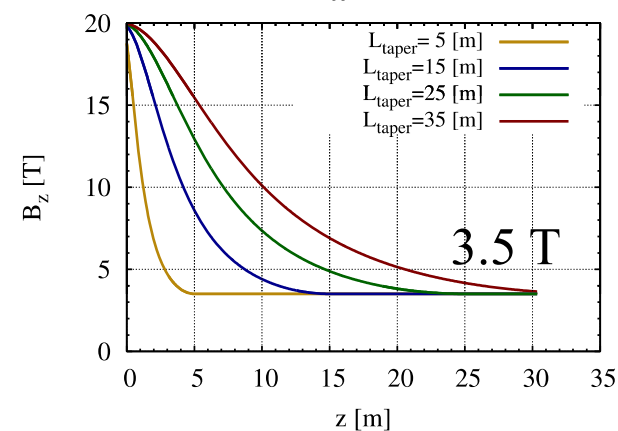
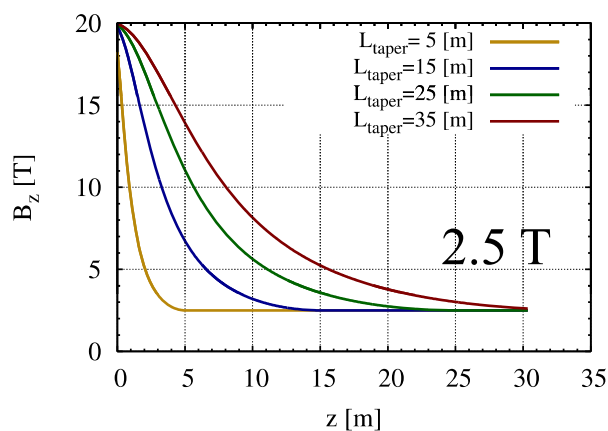
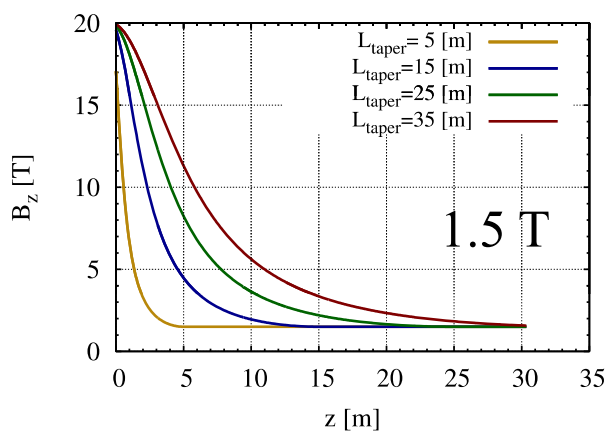
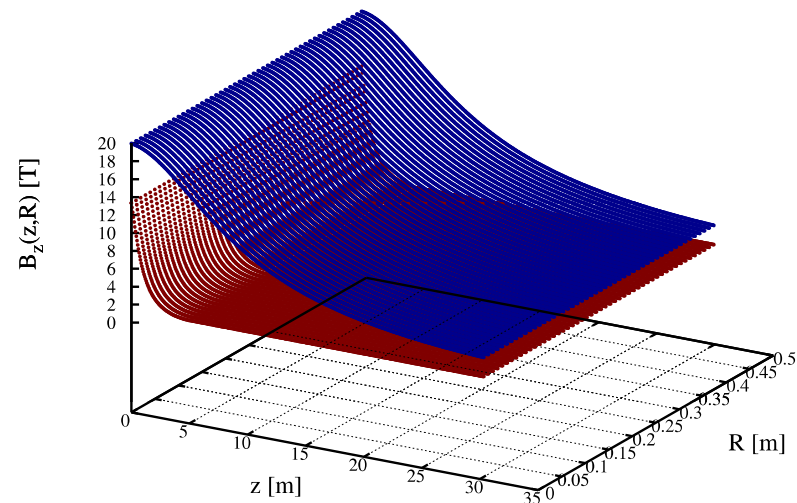

MARS SIMULATIONS & TRANSMISSION

MARS1510 Simulation:
Counting muons at 50 m with K.E. 80-140 MeV

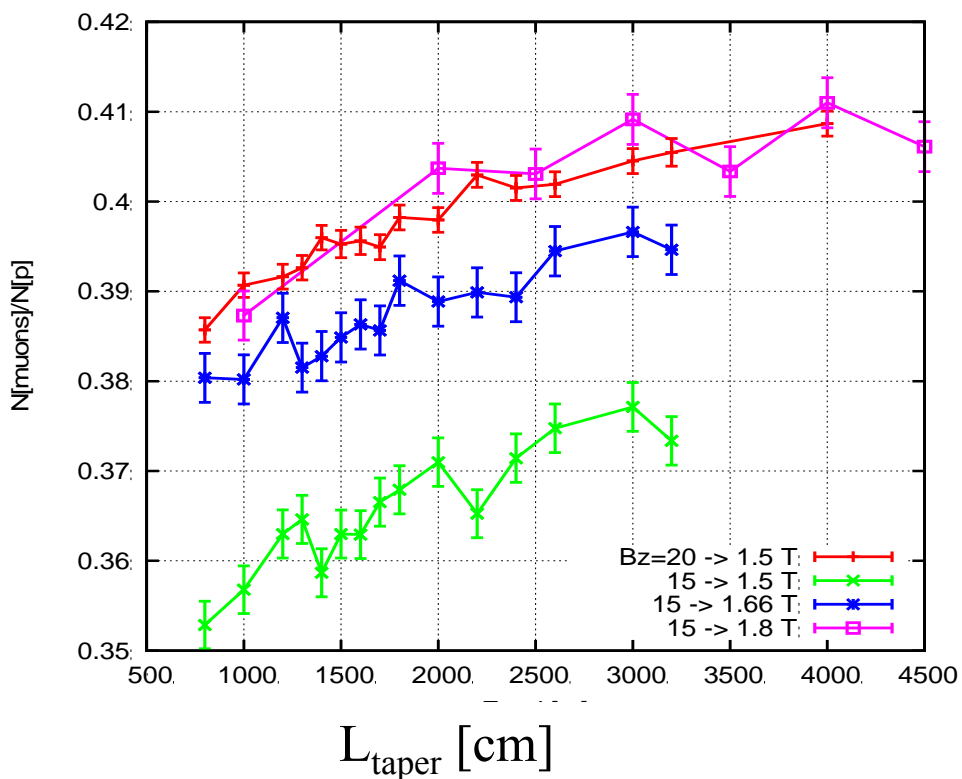
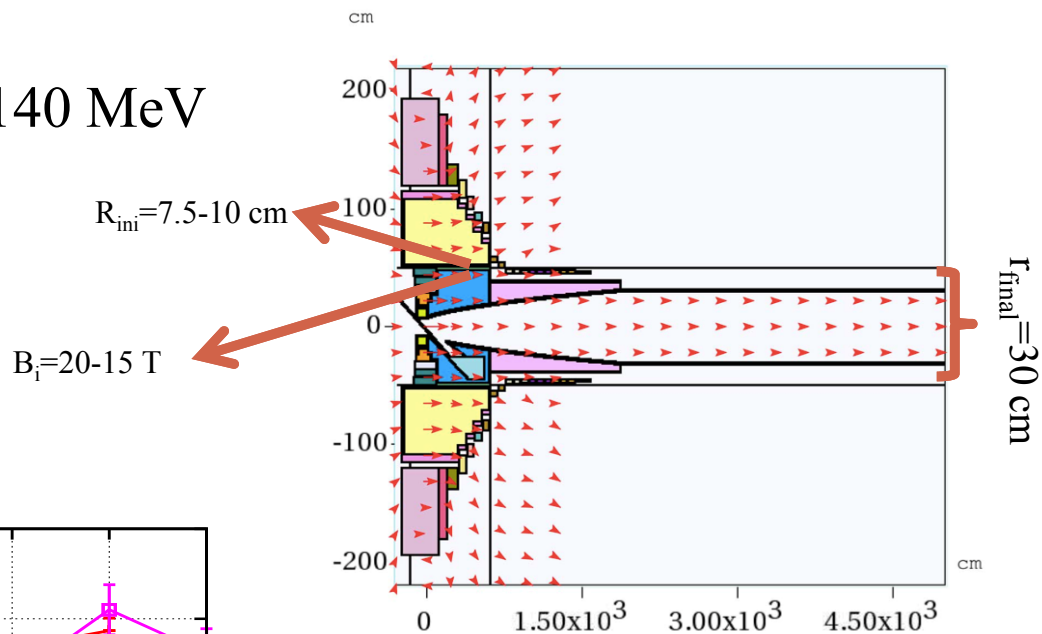

LONGITUDINAL PHASE SPACE DISTRIBUTIONS (SHORT VERSUS LONG TAPER)

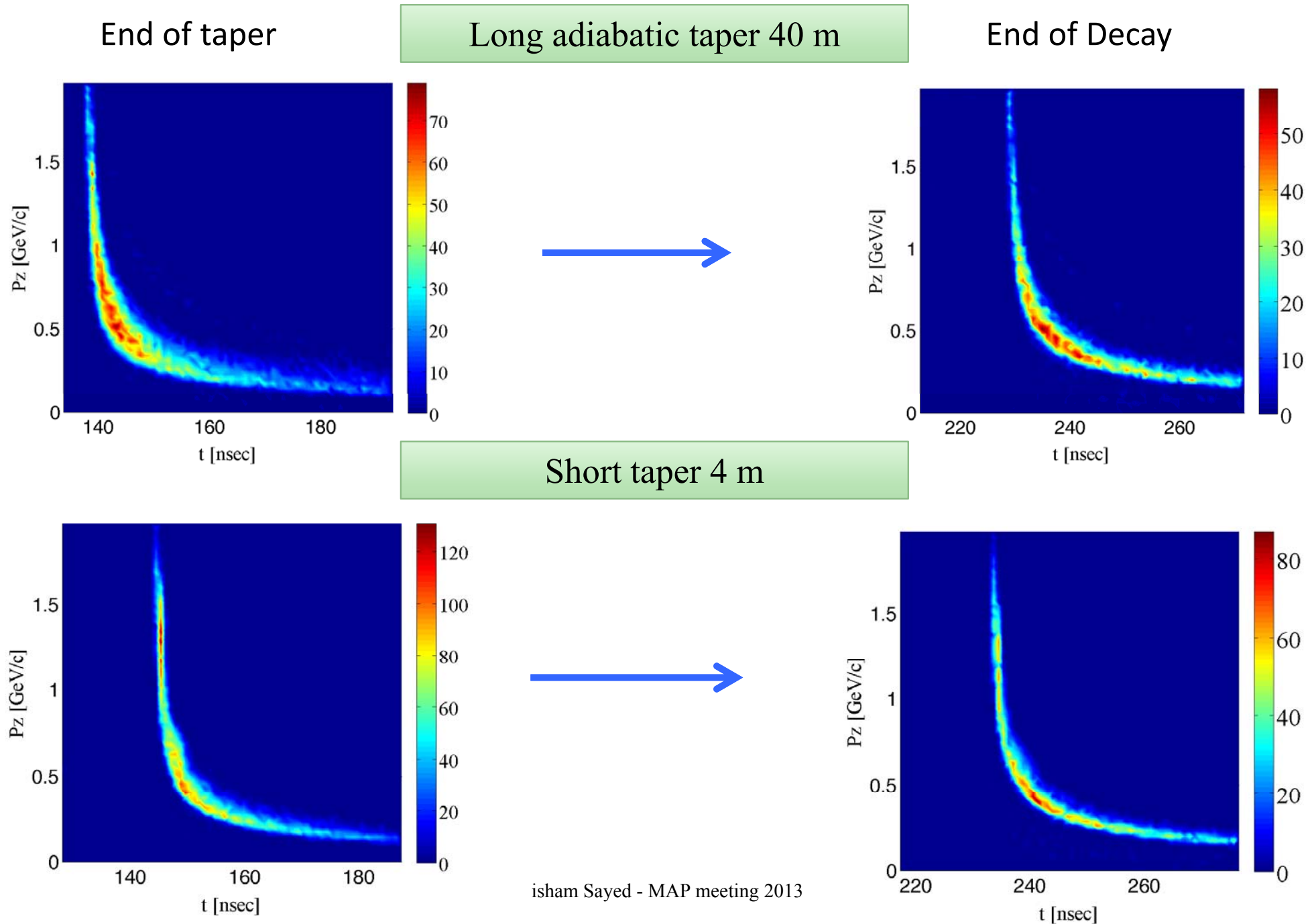

PHASE SPACE DISTRIBUTIONS (SHORT VERSUS LONG TAPER)

T-Pz Correlations at end of decay channel

Long Solenoid taper:

- More particles
- More dispersed (misses the buncher acceptance windows)

Short Solenoid taper:

more condensed distributions that fits more particles within the buncher acceptance windows

Long Taper

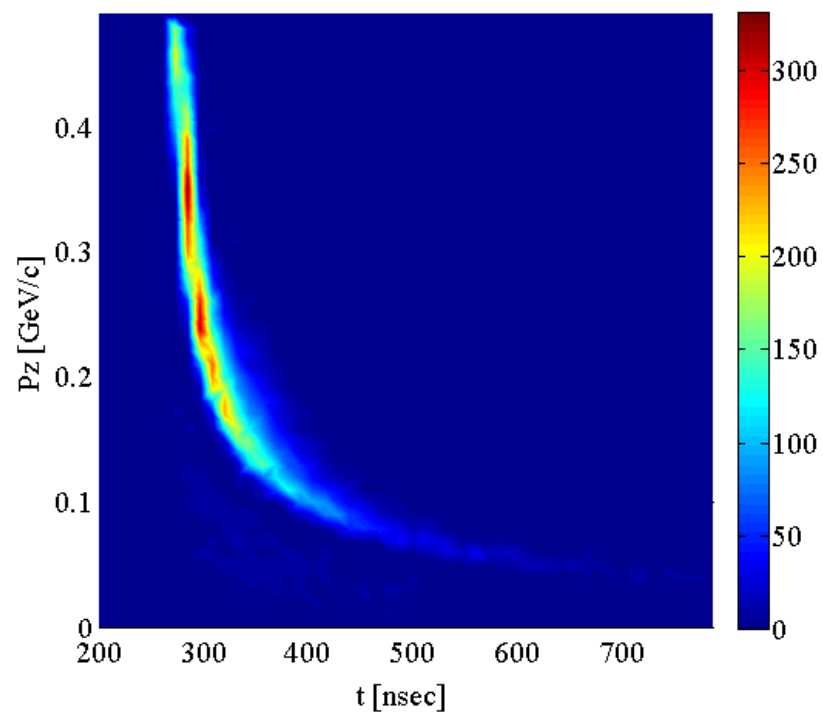

Short Taper

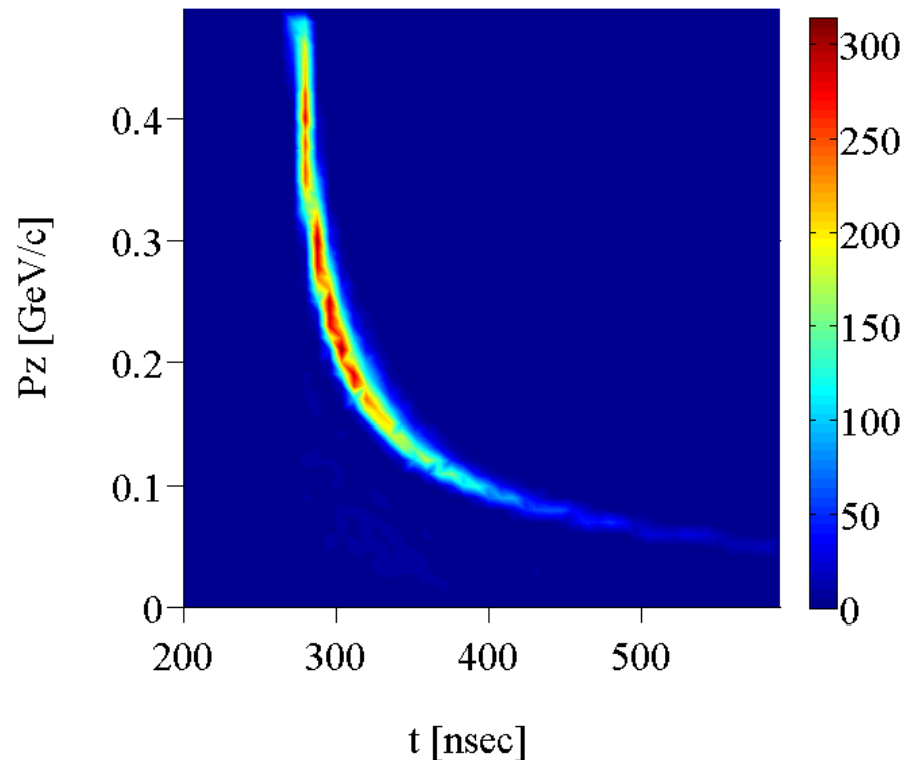

PHASE SPACE DISTRIBUTIONS (SHORT VERSUS LONG TAPER)

T-Pz phase space at end of decay channel

Long Taper 40 m

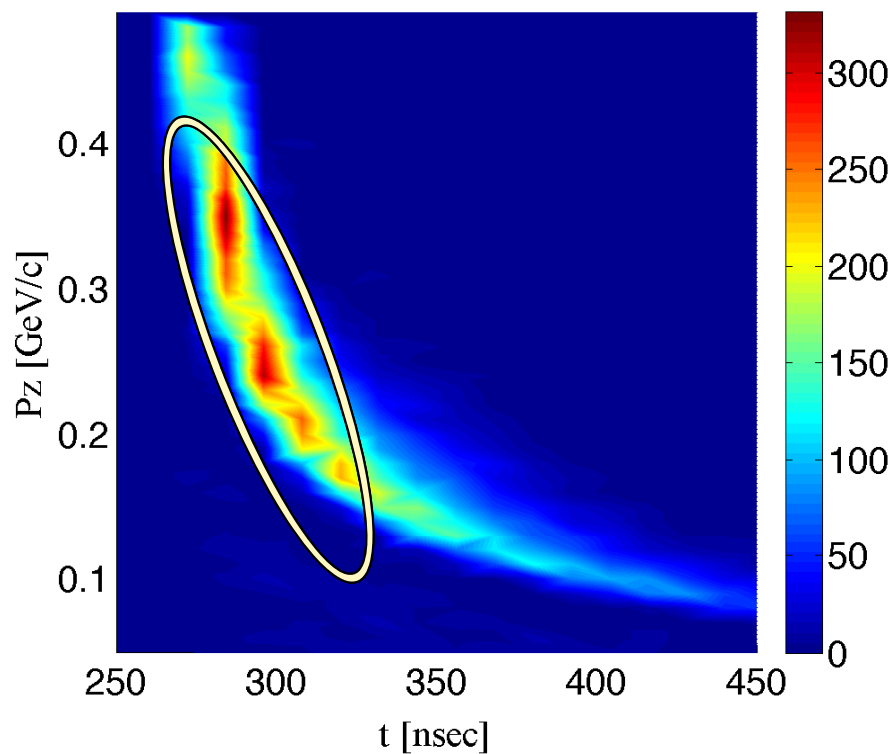

Short Taper 4 m

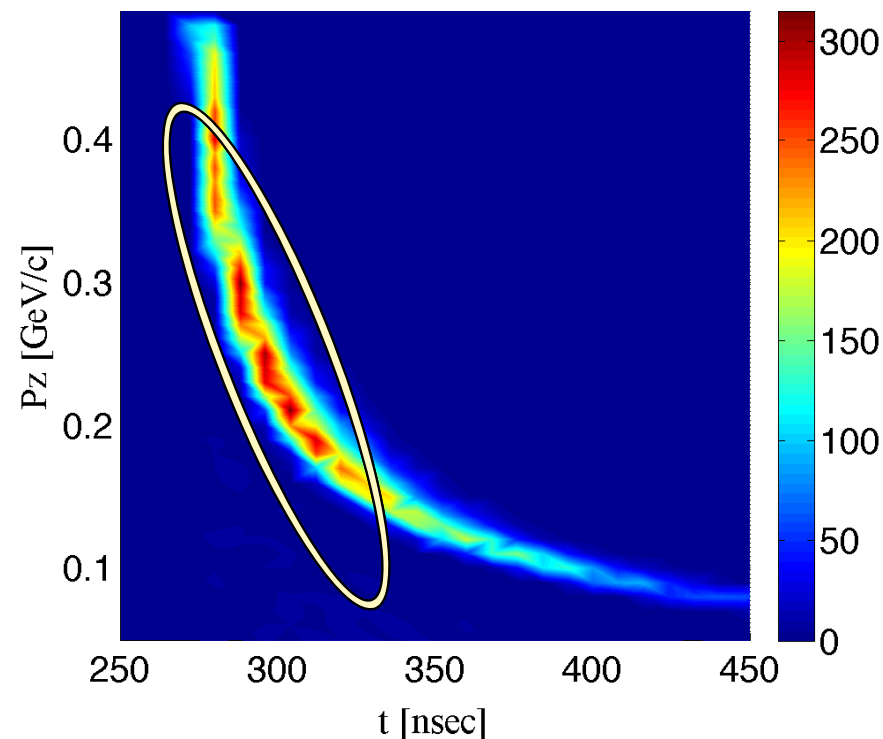

Long Solenoid taper:

- More particles
- More dispersed (misses the buncher acceptance windows)

Short Solenoid taper:

- Higher density t-pz distribution
- Fits more particles within the acceptance of buncher/rotator

PHASE SPACE - SHORT VERSUS LONG TAPER

T-Pz Correlations at end of decay channel of good particles

Bz=20-1.5 z=50 m.

Green: Initial distribution of good particles which were bunched and cooled in 4D cooling channel

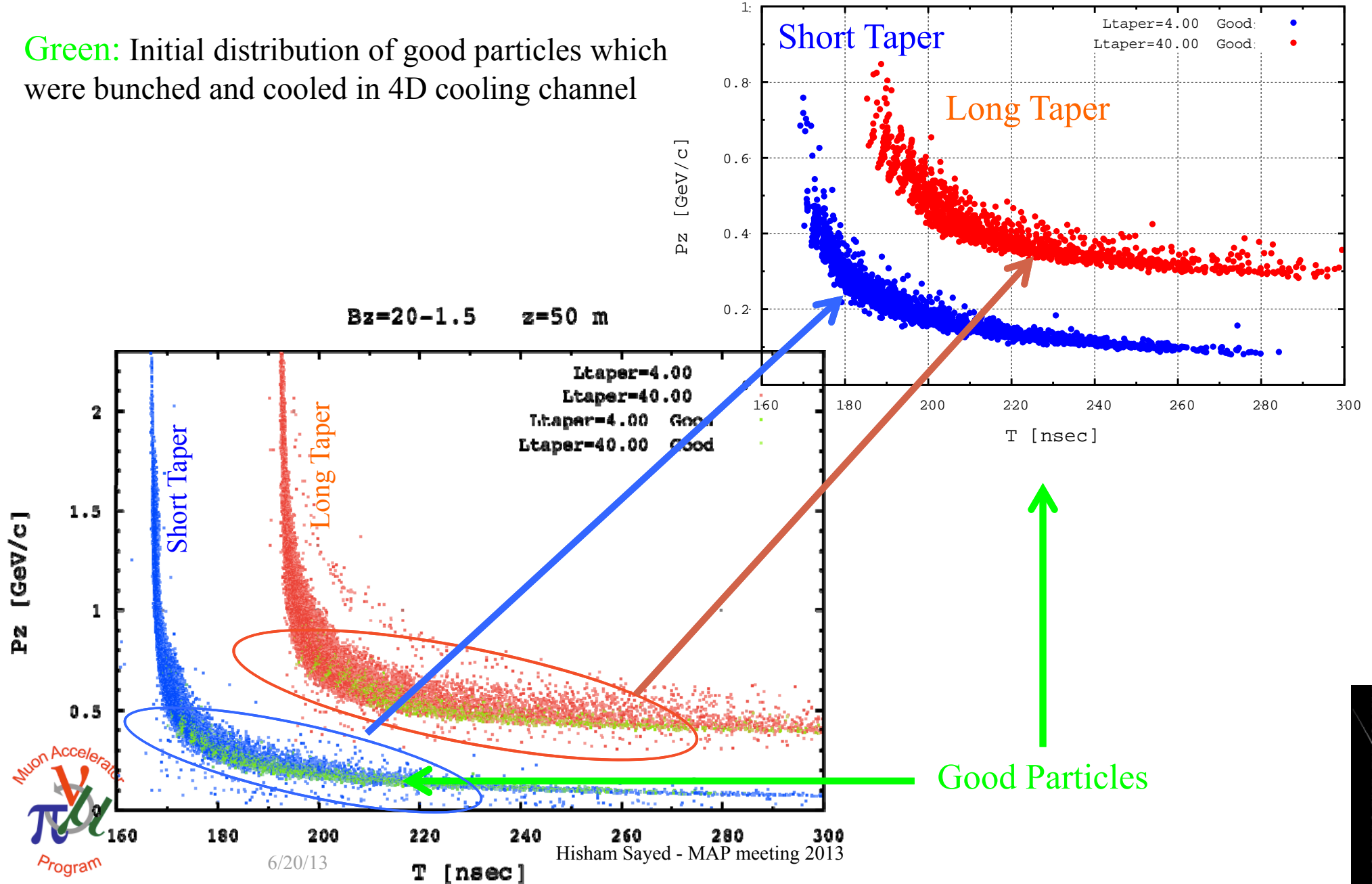

6/20/13

Hisham Sayed - MAP meeting 2013



PERFORMANCE DEPENDENCE ON TIME OF FLIGHT (RF PHASE)

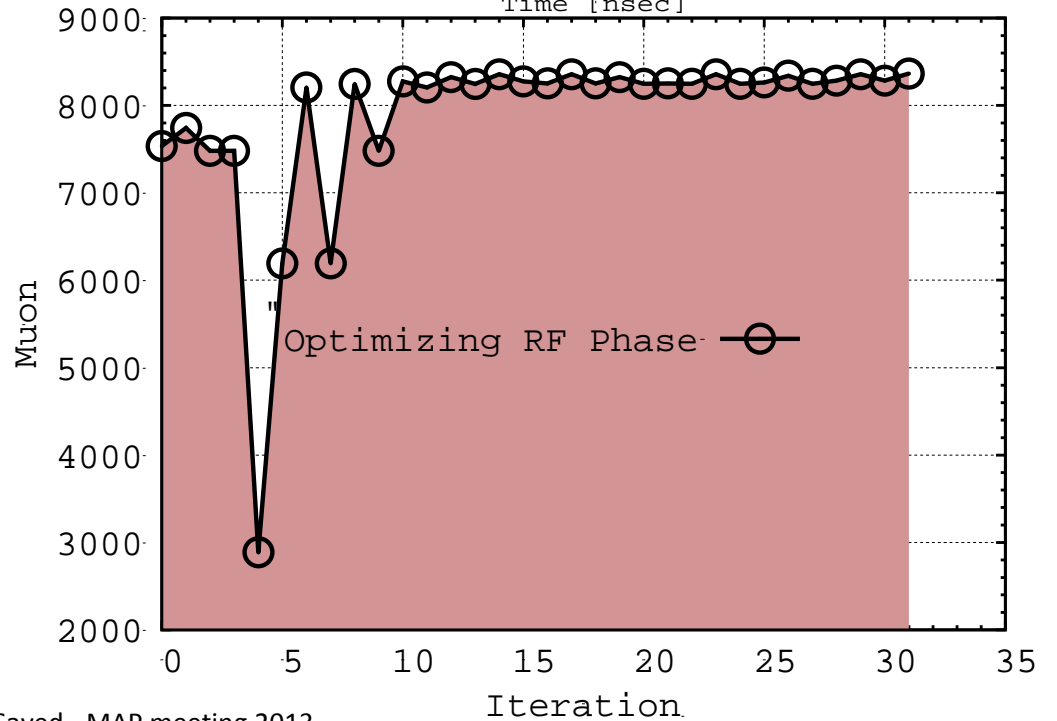
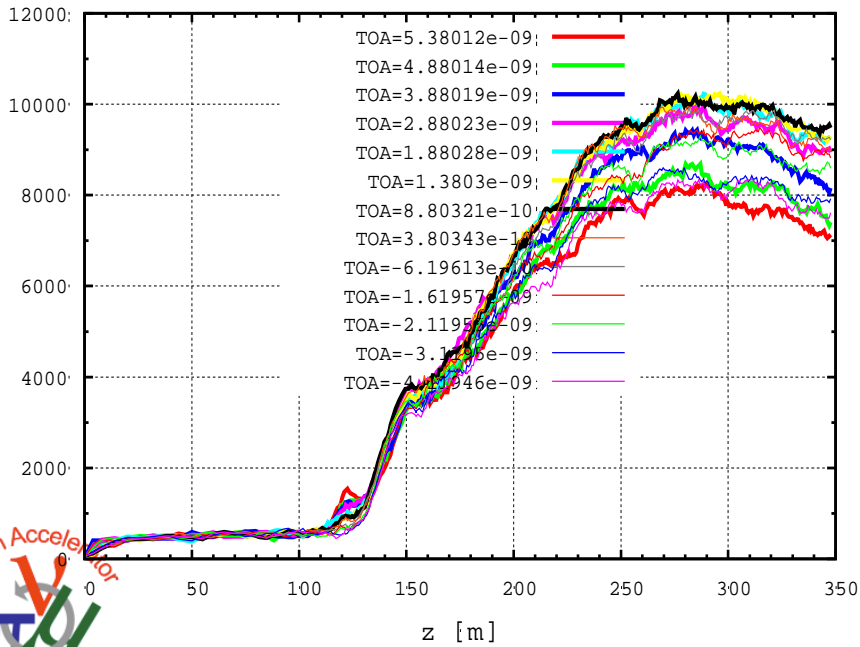
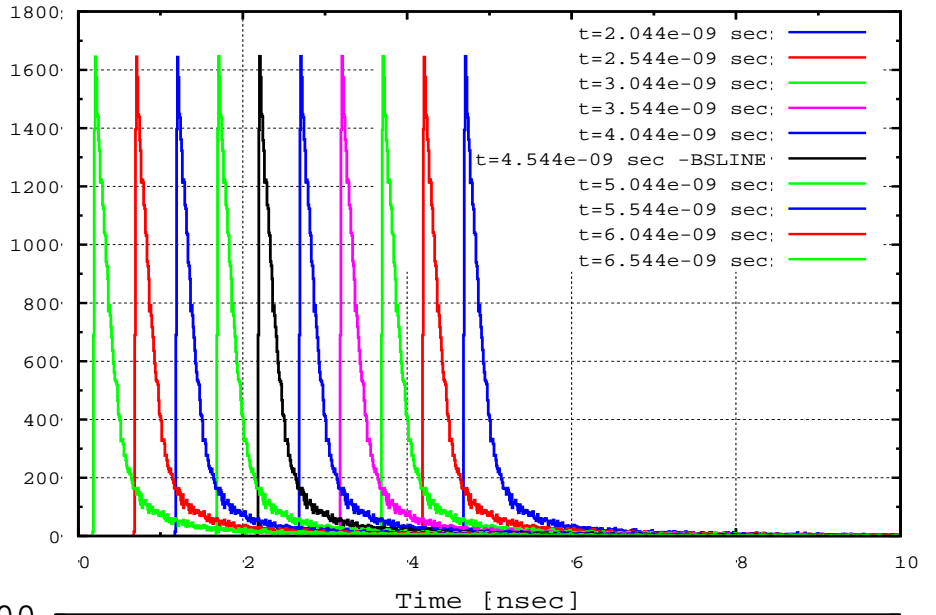
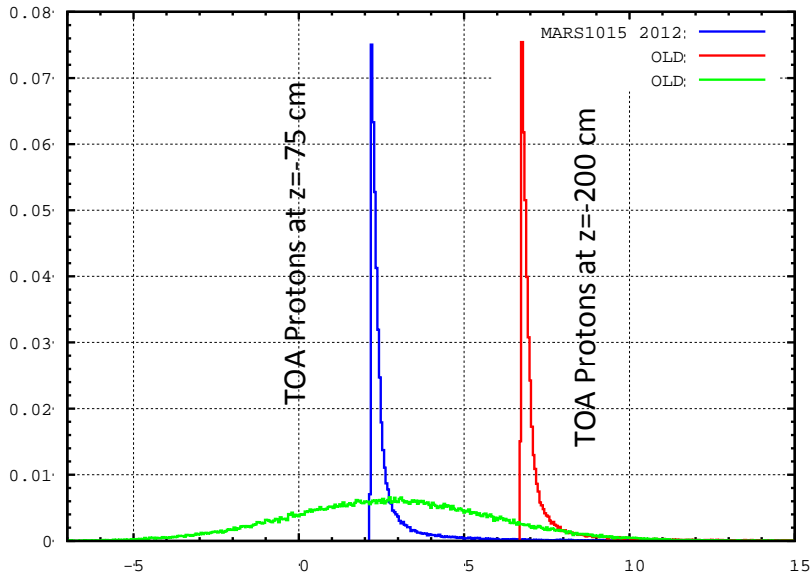

6/20/13

Hisham Sayed - MAP meeting 2013



FRONT END PERFORMANCE

Using baseline cooling section
(140 cooling cell)

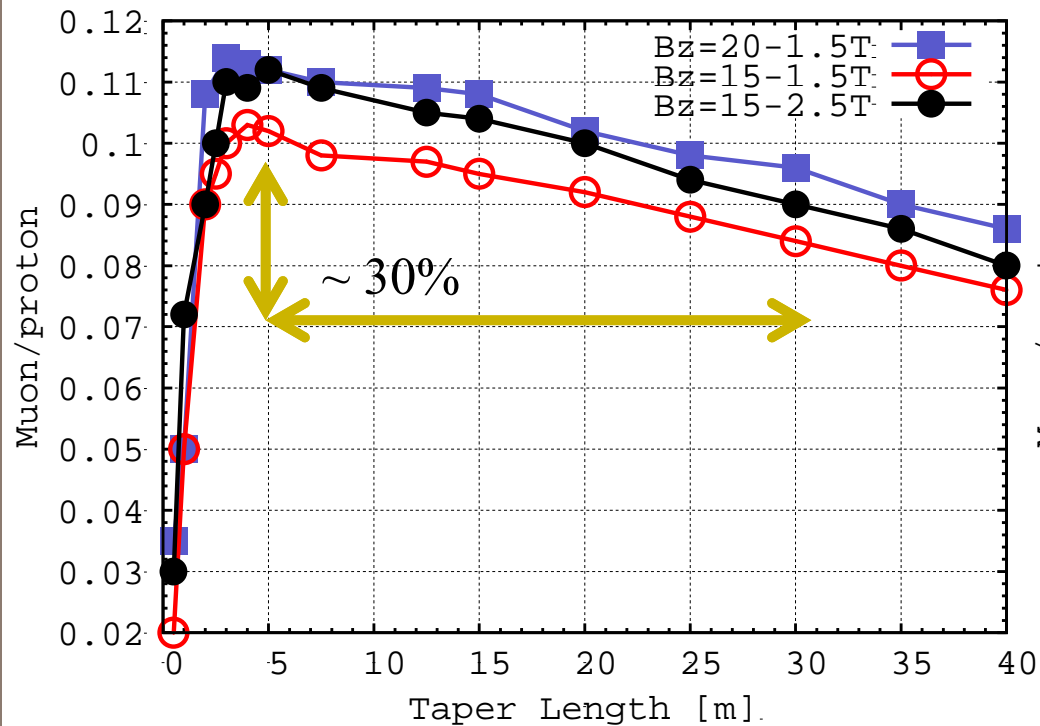

Using longer cooling section
(200 Cooling cell)

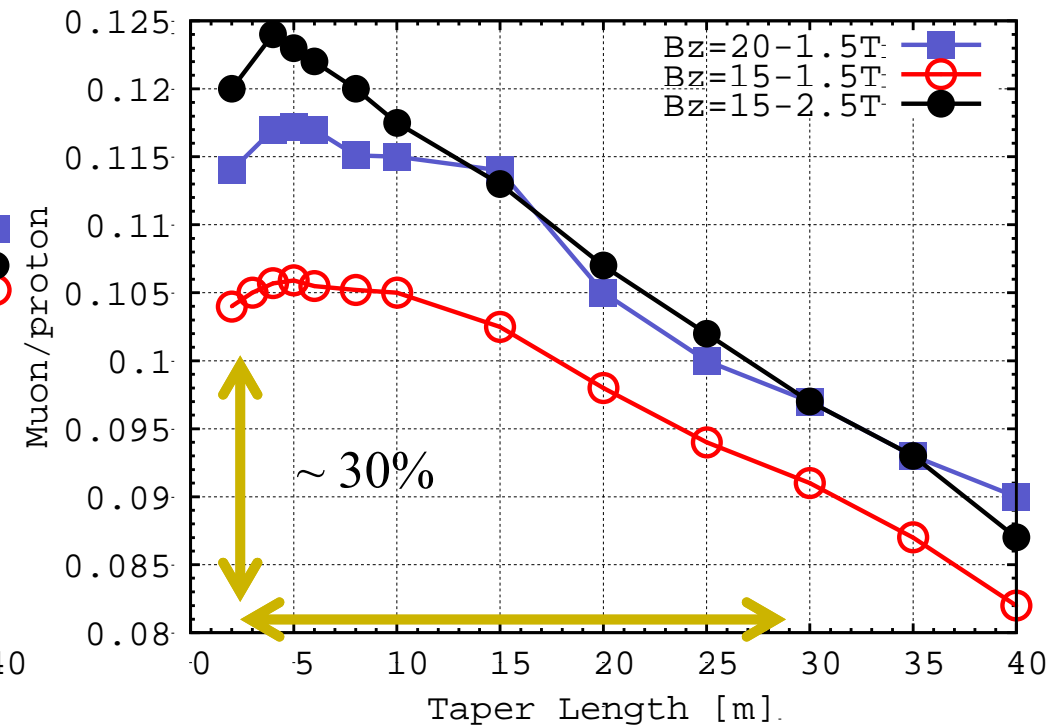

High statistics tracking of Muons through the front end

FRONT END PERFORMANCE

Using longer cooling section
(200 Cooling cell)

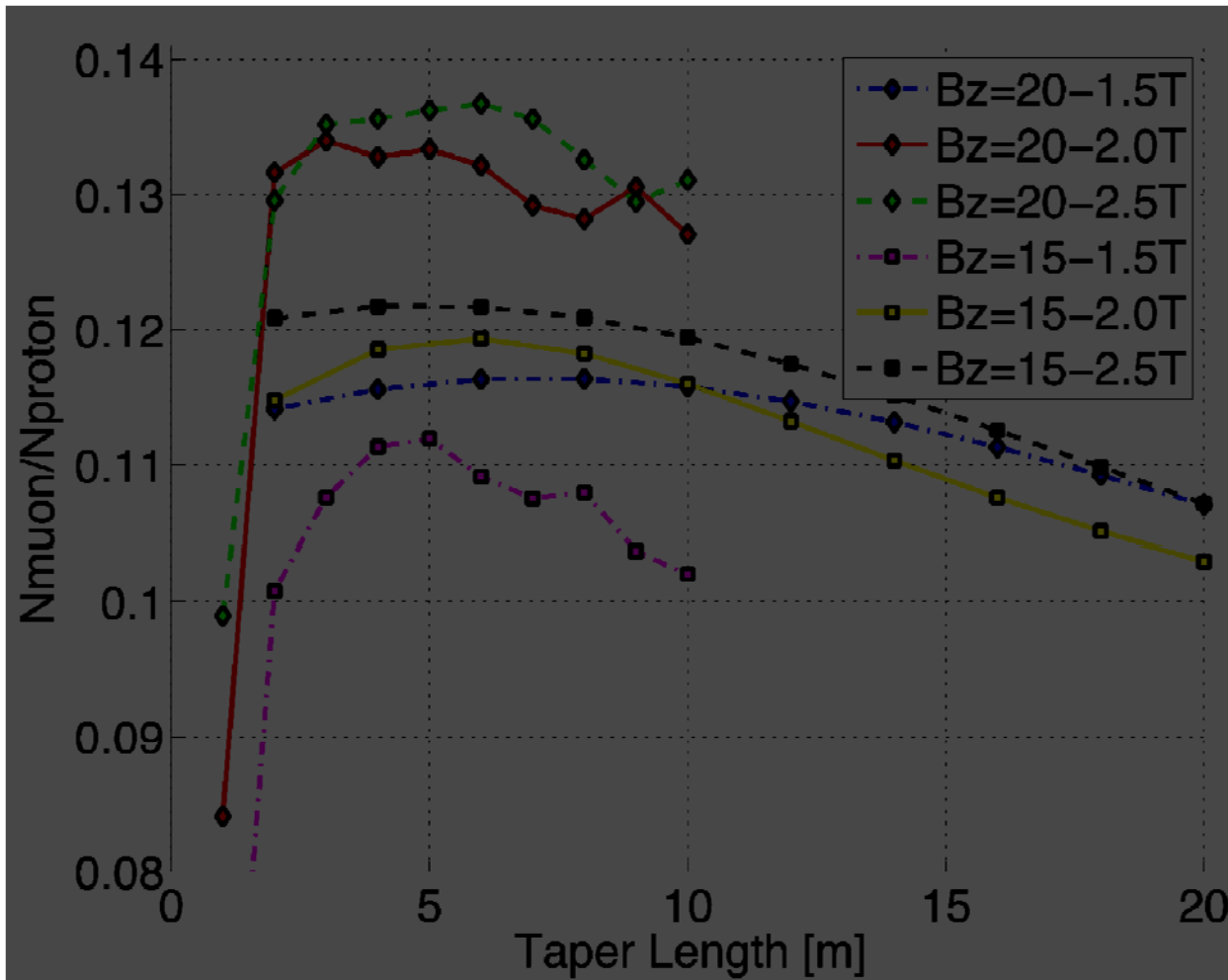

High statistics tracking of Muons through the front end

MUON YIELD VERSUS END FIELD & BUNCH LENGTH

Muon yield versus end field

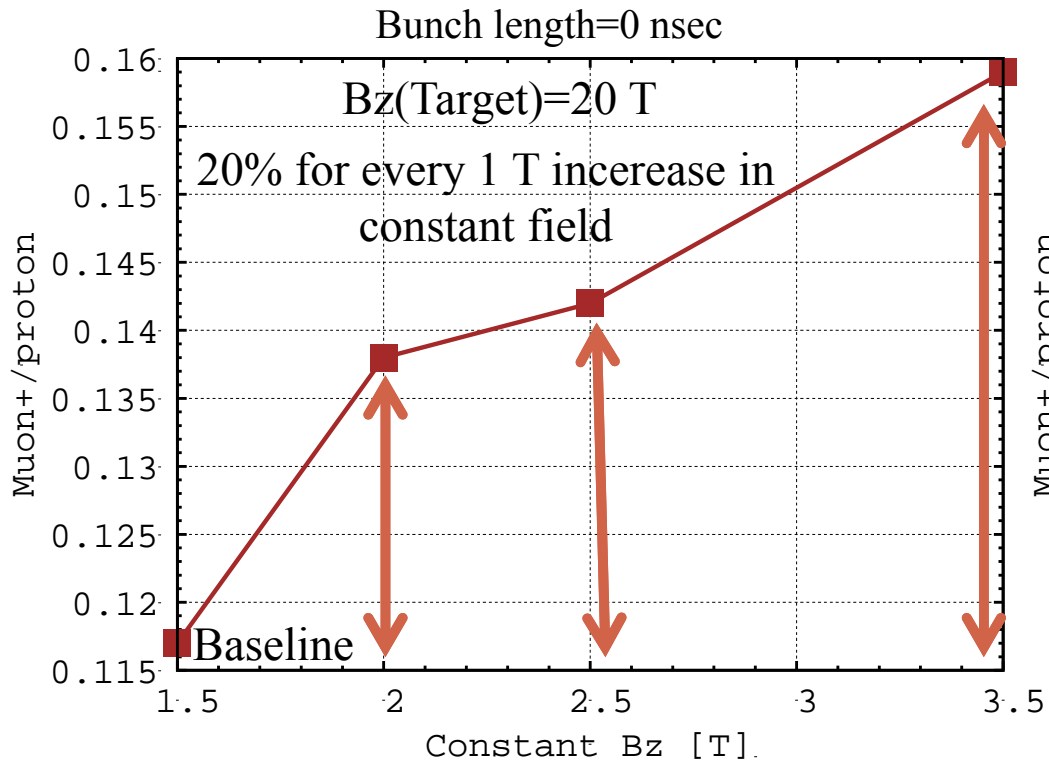

Performance of FE as function of Constant solenoid field in Decay Channel – Buncher – Rotator (matched to +/- 2.8 T ionization cooling channel)

Muon yield versus Proton Bunch Length

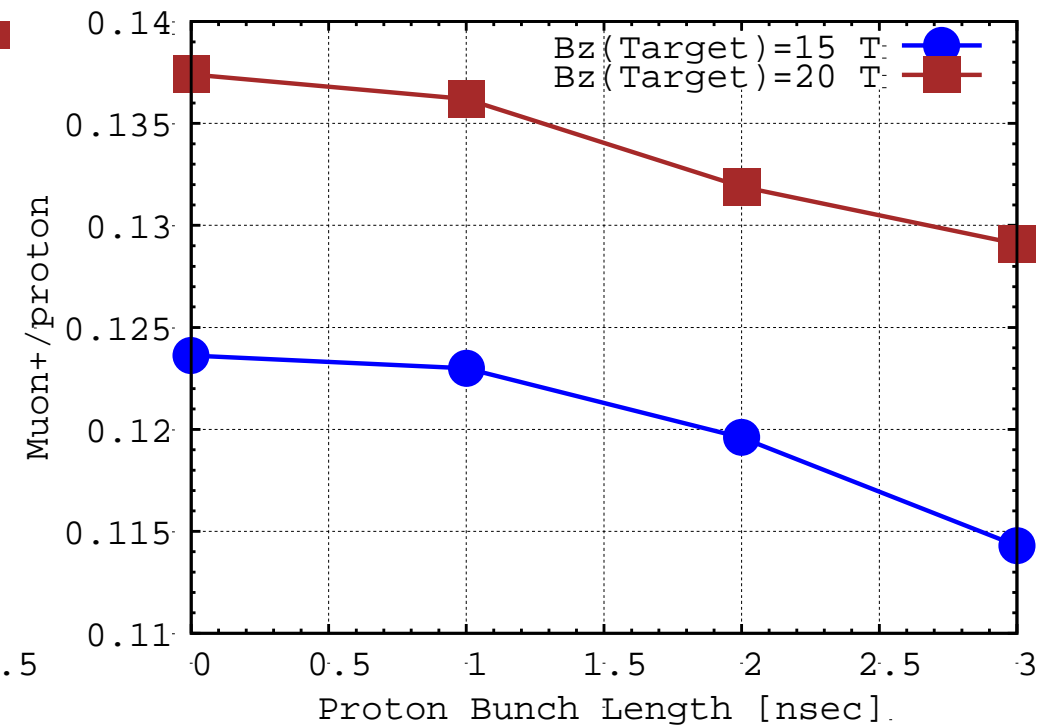

~ 3% loss per 1 nsec increase in bunch length

NEW SHORT TARGET CAPTURE REALISTIC MAGNET (WEGGEL)

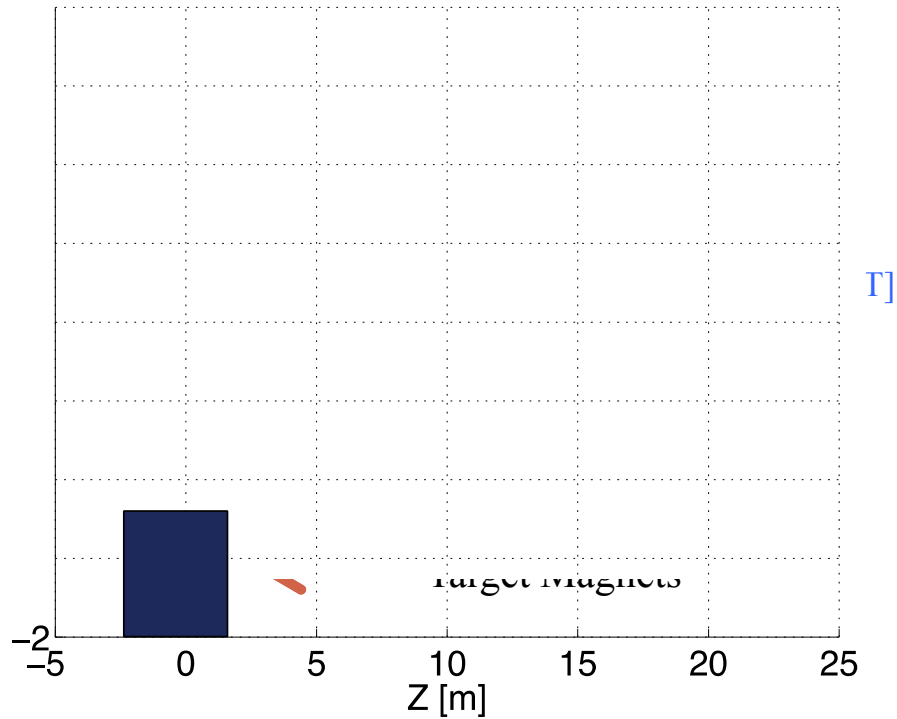

➔ Muon Target Capture Magnet
Short Taper length = 7 m- B=20-1.5 T

➔ Muon Target Capture Magnet
Short Taper length = 5 m- B=20-2.5 T

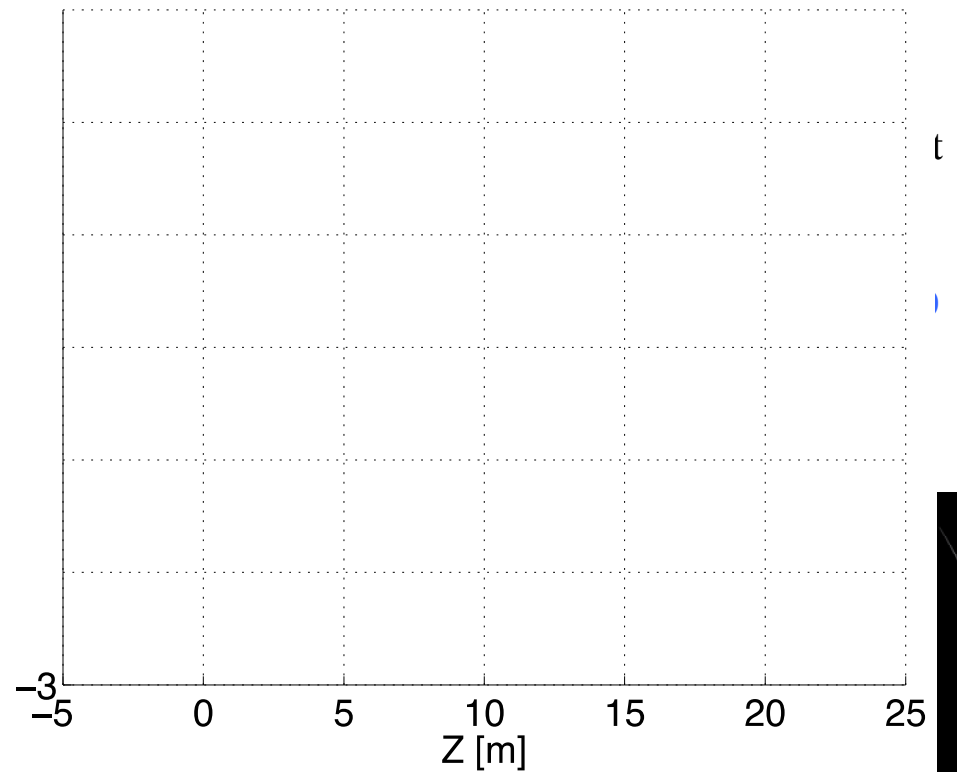

7/25/2013

Hisham Sayed BNL



NEW SHORT TARGET CAPTURE MAGNET (WEGGEL)

Muon Target Short Taper Magnet taper length =7 m- B=20-1.5 & 2.5 T

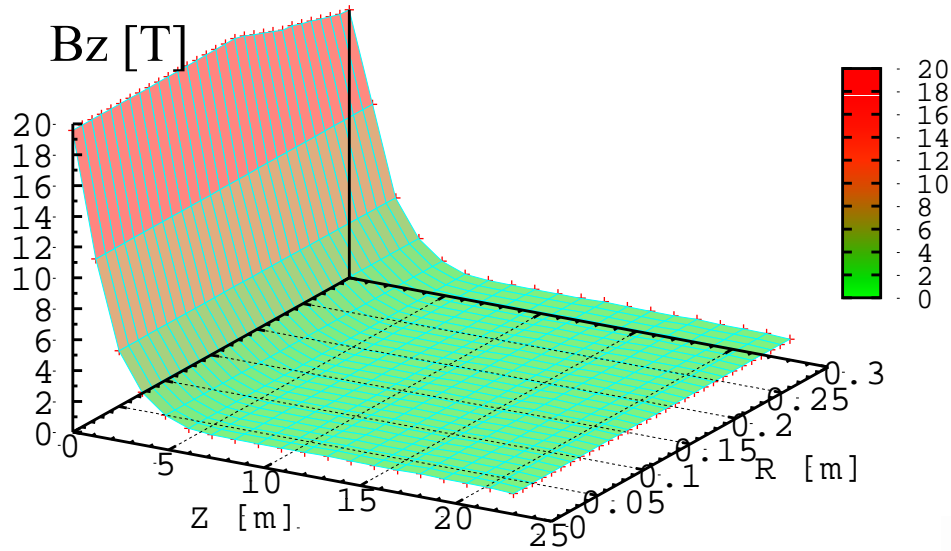

Target SC Magnets Field Map calculated from realistic coils

Engineering (V. Grave)
IDS120_20-1.5T7m2+5 Cryo 1

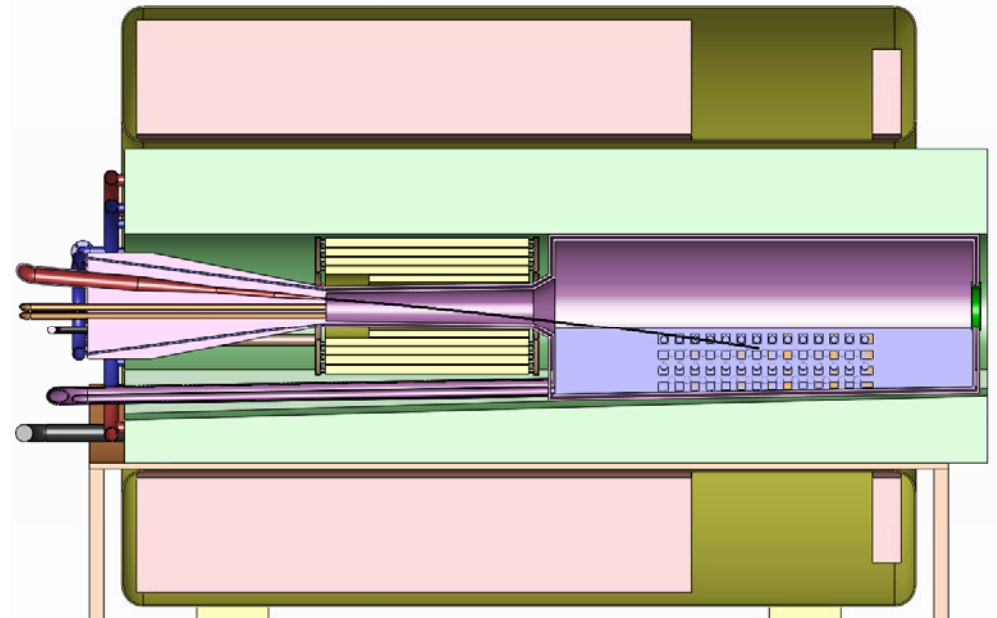

NEW DECAY CHANNEL REALISTIC MAGNET (WEGGEL)

- The pions produced in the target decay to muons in a Decay Channel (50 m)
- Three superconducting coils (5-m-long) $B_z(r=0) \sim 1.5$ or 2.5 T solenoid field.
- Suppress stop bands in the momentum transmission.

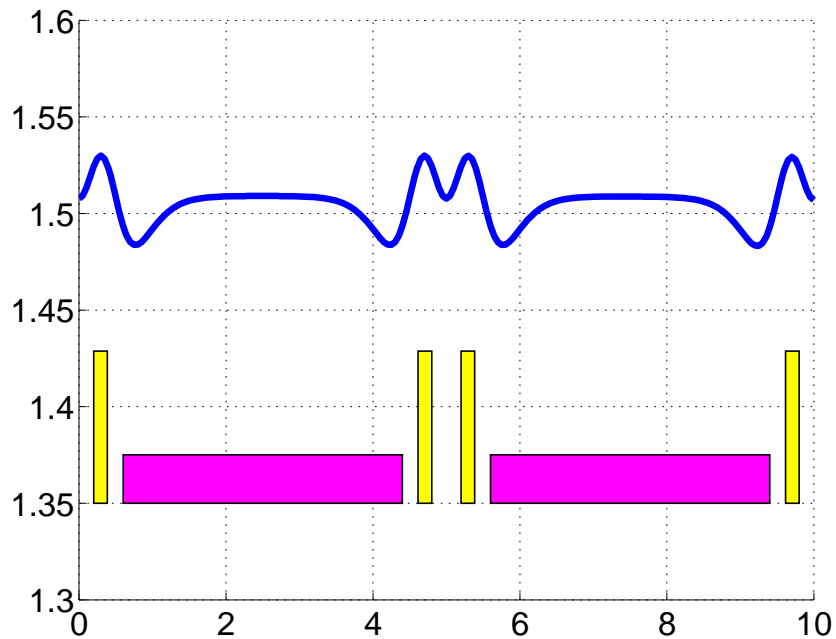

Axial-field profile of two Decay-Channel modules

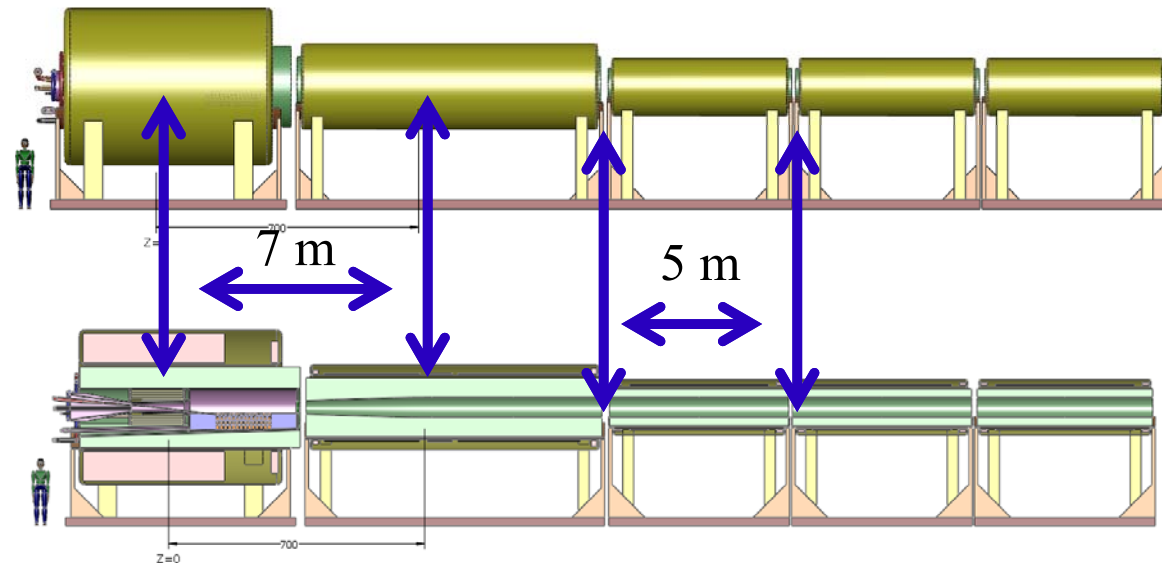

IDS120L20-1.5T 7m

Magnet	Length [m]	Inner R [m]	Outer R [m]	J [A/mm ²]
1	0.19	0.6	0.68	47.18
2	3.8	0.6	0.63	40.00
3	0.19	0.6	0.68	47.18

REALISTIC COIL BASED DECAY CHANNEL SOLENOID STOP BAND STUDY

Suppression of stop bands in the Decay Channel:

Tracking muons through decay channel 10 cells (50 m) optimize magnet design for best performance

Transmission:	
Constant 1.5 Solenoid Field	%67
IDS120L20to1.5T7m	%62
Modified IDS120L20to1.5T7m	%66

IDS120L20to1.5T7m

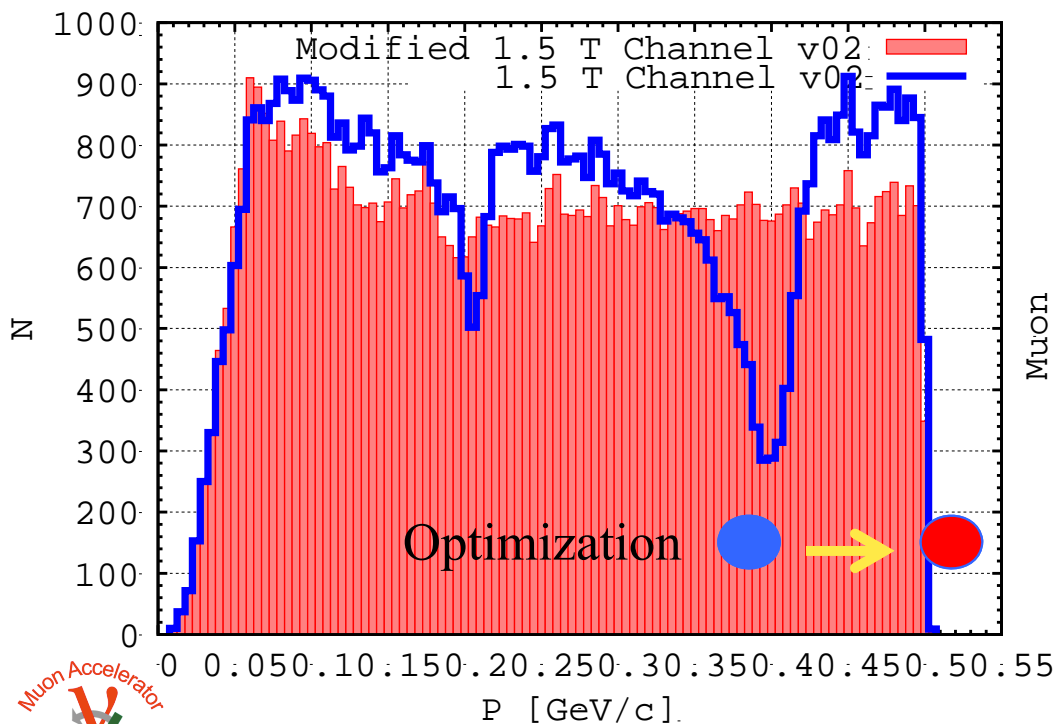

IDS120L20to1.5T7m

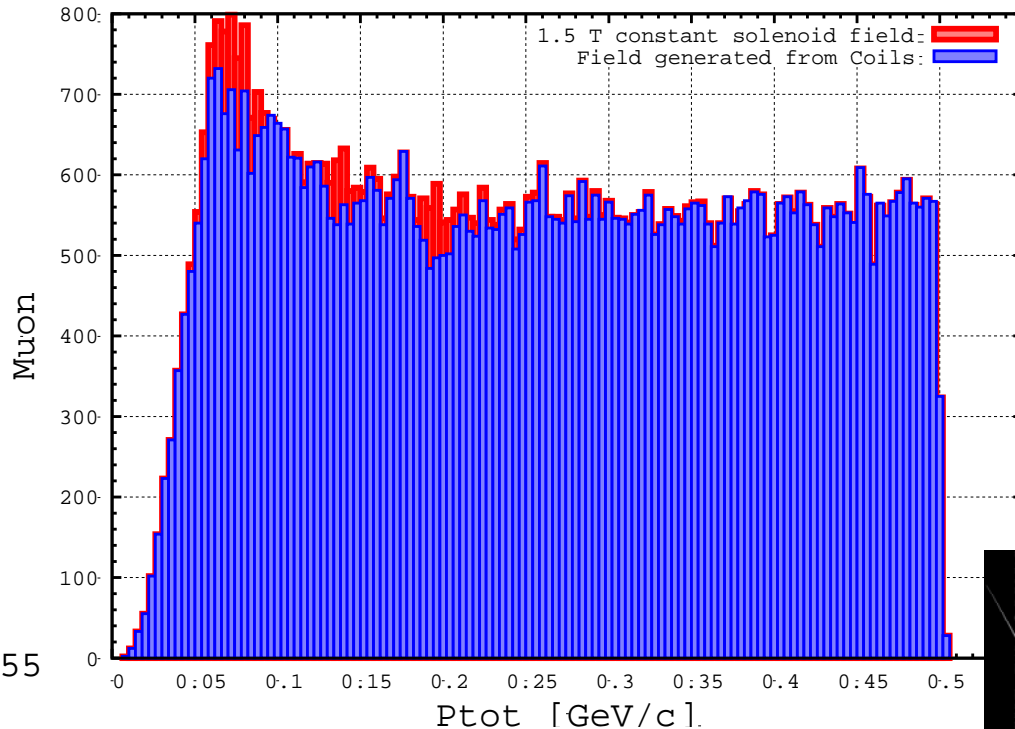

CONCLUSION & SUMMARY

1- Target Solenoid parameters that affect the particle Capture & Transmission at target or after cooling

Initial peak Field – Taper length – End Field

2- Impact:

Short taper preserves the longitudinal phase-space → muons can be captured efficiently in the buncher-phase rotation sections and more muons at the end of cooling.

The maximum yield requires taper length of 7-5 m for all cases (20-15T) (1.5-3.5T) for any bunch length.

3- Final constant end field increases the yield by 20% for every 1 T increase in the field beyond the 1.5 T baseline

4- Initial proton bunch length influence the muon/proton yield at the end of the cooling channel
~ 3% reduction per 1 nsec increase in bunch length.

5- Realistic Coil design.