

Cooling Design of Shielding at MOMENT

Jianfei Tong, Qingnian Xu, YuanYe, Binzhou, Tianjiao Liang

August 11, 2015

Institute of High Energy Physics, CAS



Outline

1. Introduction
2. Heat Deposition Calculation
3. Cooling Structure Design & CFD Analysis

2.1 Heat deposition: Calculation Model of Fluka

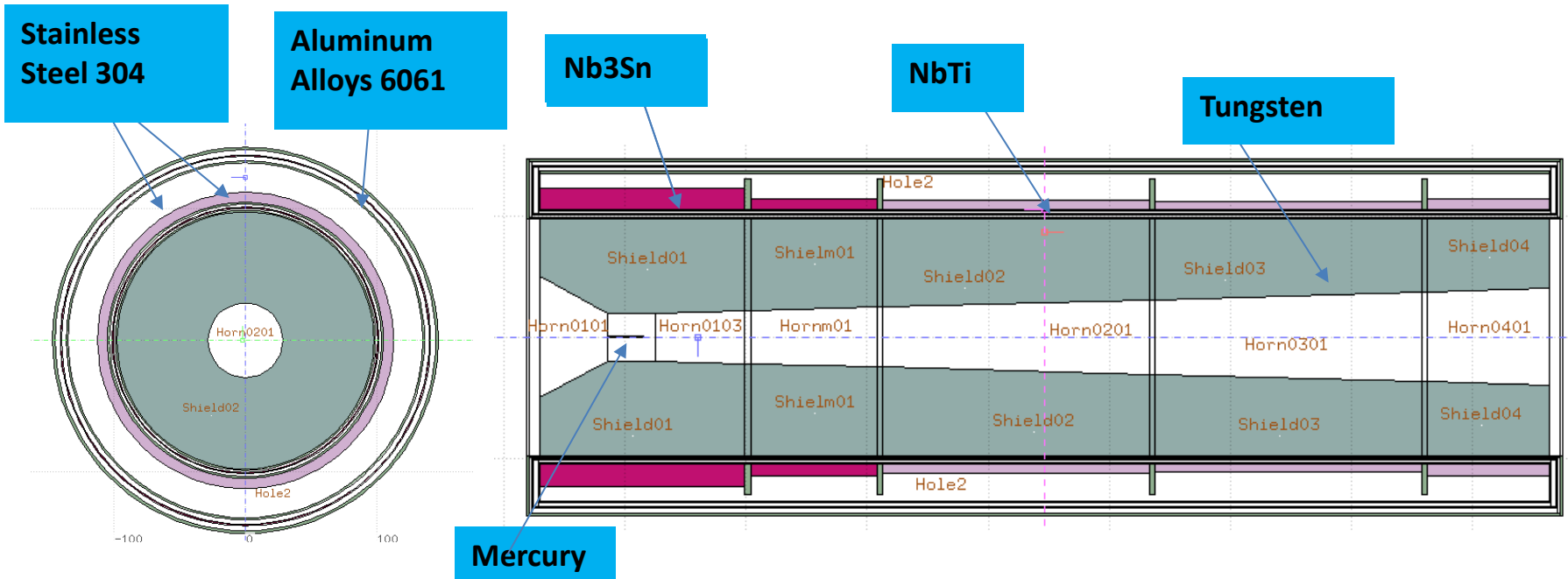

Stainless steel 304: Fe 0.6775, Si 0.01, Mn 0.02, Cr 0.19, Ni 0.0925, N 0.01.

**Aluminum Alloys 6061: Al 0.9725, Si 0.006, Cu 0.002, Mg 0.01, Zn 0.0025,
Mn 0.0015, Ti 0.0015, Cr 0.002, Fe 0.0035.**

Nb3Sn: Nb 0.482, Cu 0.518.

**NbTi conductor: polyimide 0.079 (polyimide C6H11ON, Density 1.41 g/cc),
Al 0.731, Cu 0.09, NbTi 0.1**

Mercury: Density 13.534 g/cc

Tungsten: Density 19.3 g/cc

2.2 Heat deposition: Results

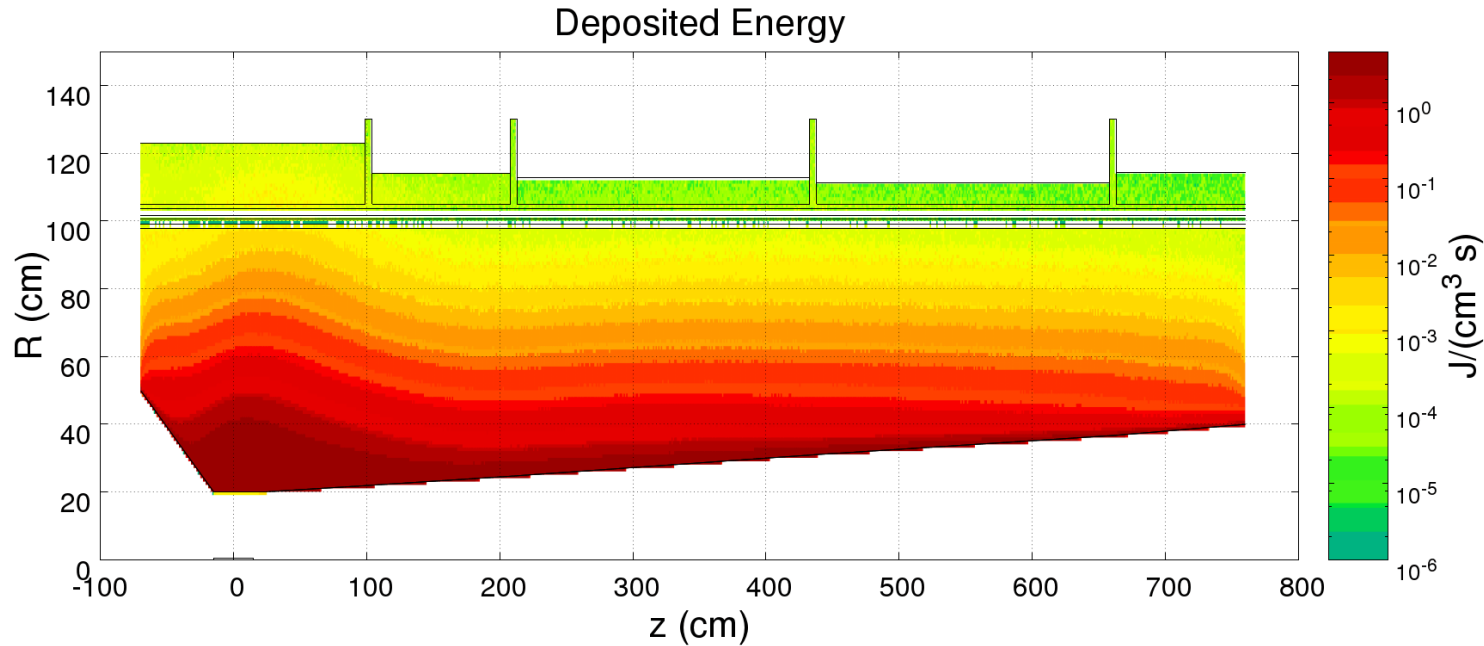

Heat deposition for Proton beam power = 15 MW

Proton: 1.5 GeV, 10 mA

Target: Hg Length=300 mm, R=5 mm

Shielding: Tungsten

Heat load on Shielding: 9.9 MW

Max volumetric heat source= $2.2 \times 10^8 [W m^{-3}]$

3.1 Cooling Structure Design Criterion

1. For the shielding material density should be as high as possible, which reduce the heat load on superconducting magnets, the total volume of cooling channel can reduce the density of shielding and should be as small as possible;
2. It's not a good choice of cooling channel face to magnet, or along the radius direction, for the particle jet effect; The coolant passing through the shielding from front to rear also can prevent the irradiation damage on magnets;
3. Multiple rows of Mini-Channel with reasonable size can increase the heat transfer area and prevent decreasing the density too much. For the possessing difficulty of the tungsten, the channel should be as simple as possible;
4. For the high volumetric heat in shielding, the cooling channel should be designed to keep the shielding in demand especially near the target.

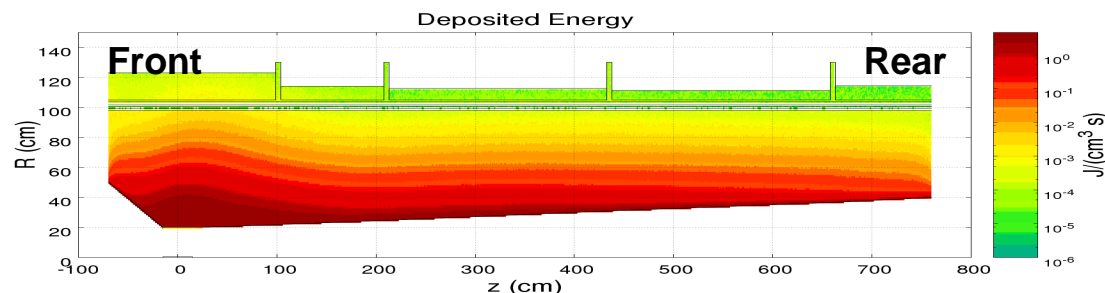

3.2 Coolant choice

1. Water : good choice, inexpensive, high thermal conductivity, high material density, tungsten has to be clad by tantalum
2. Helium : alternative choice, expensive, no new nuclide, tungsten no need clad by tantalum
3. Liquid metal (difficulty to deal with new generation of nuclides)

	Heat Conduitivity (W /m-K)	Special Heat Capacity (J/kg-K)	Visousity (Pa/s)	Density (kg/m ³)
Water	0.6069	4181.7	8.899e-4	997
Helium@1atm 300K	0.1415	5240	1.86e-05	0.179
Helium@3Mpa 300K	0.158	5191	2.01e-05	4.78

Water: Max velocity 5 m/s; Goal: max temperature of water below 150 °C (keep in liquid phase), max temperature of tungsten below 800°C

Helium : Max velocity 100 m/s; Goal: max temperature below 800°C

3.3 Cooling Structure design

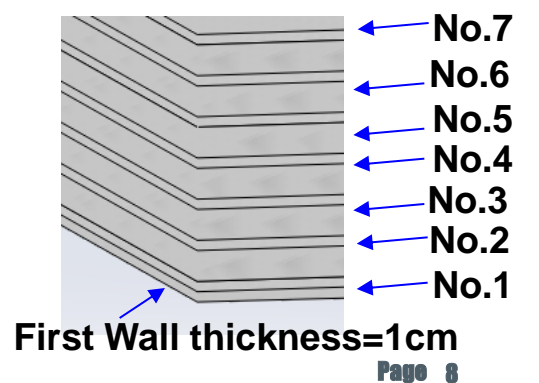
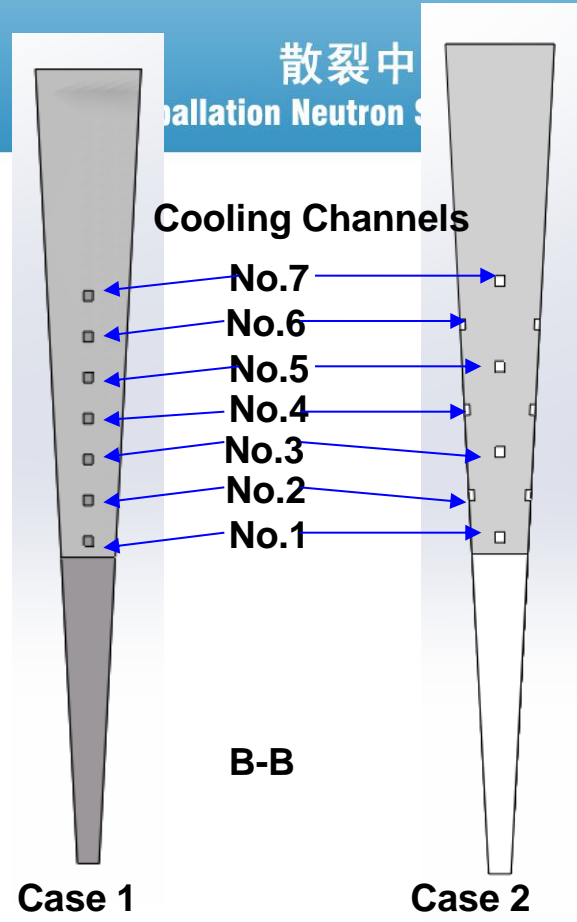
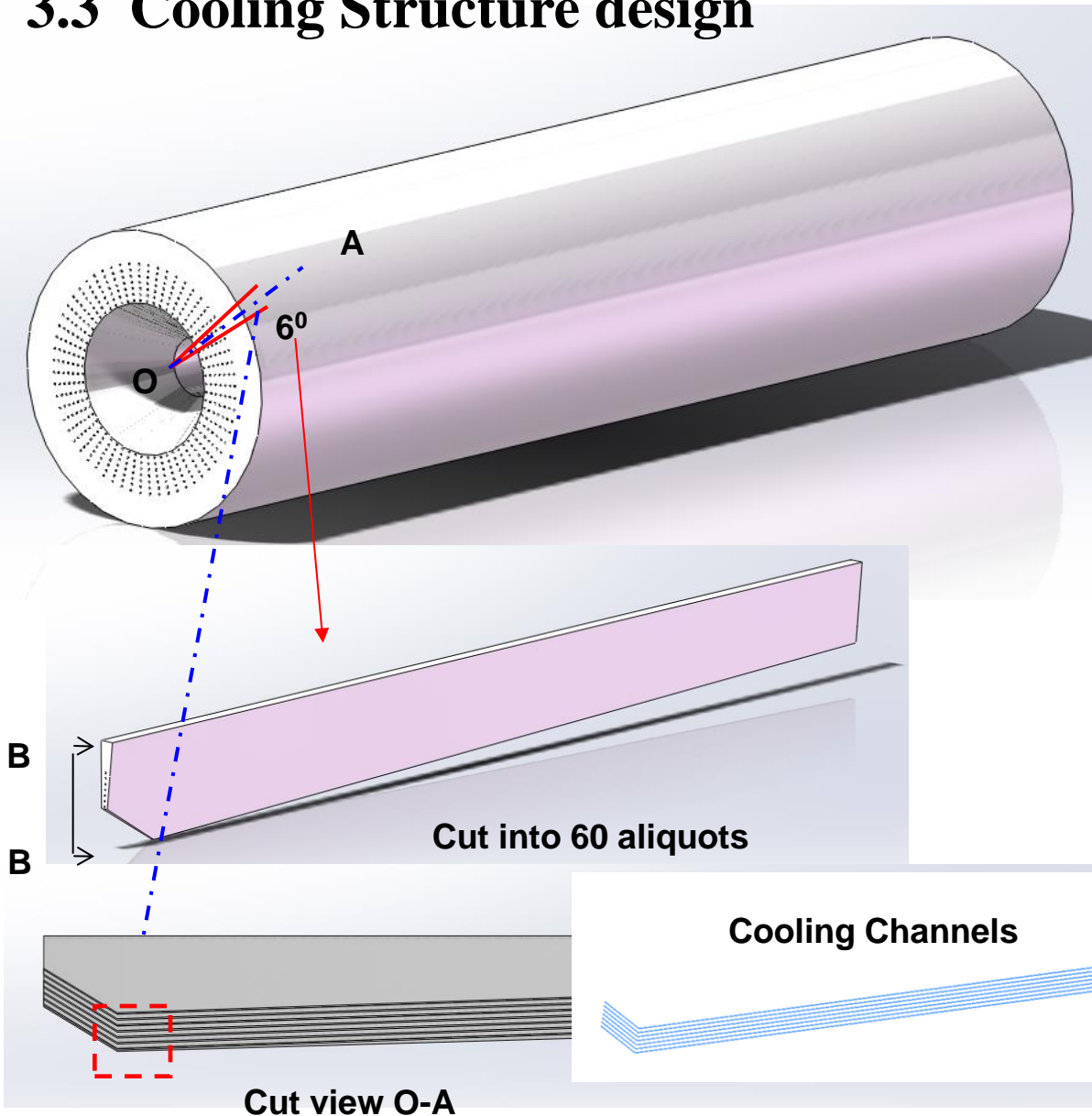

3.4 Government Equation & Calculation Software

$$\frac{\partial \rho}{\partial t} + \nabla \cdot (\rho U) = 0$$

$$\frac{\partial \rho U}{\partial t} + \nabla \cdot (\rho U \otimes U) - \nabla \cdot (\mu_{\text{eff}} \nabla U) = -\nabla P + \nabla \cdot (\mu_{\text{eff}} \nabla U)^T$$

$$\frac{\partial \rho h_{\text{tot}}}{\partial t} - \frac{\partial p}{\partial t} + \nabla \cdot (\rho U h_{\text{tot}}) = \nabla \cdot (\lambda \nabla T) + S_E$$

Finite Volume Method

Software: Ansys CFX

S_E heat source

$$\frac{\partial \rho k}{\partial t} + \nabla \cdot (\rho U k) = P_k - \beta^* \rho \omega k + \nabla \cdot [(\mu + \mu_t / \sigma_k) \nabla k]$$

$$\frac{\partial \rho \omega}{\partial t} + \bar{u}_j \frac{\partial \rho \omega}{\partial x_j} = \alpha_1 \frac{\omega}{k} P_k - \rho \beta \omega^2 + 2(1 - F_1) \rho \frac{\sigma_{\omega 2}}{\omega} \frac{\partial k}{\partial x_j} \frac{\partial \omega}{\partial x_j} + \frac{\partial}{\partial x_j} \left[(\mu + \mu_t / \sigma_w) \frac{\partial k}{\partial x_j} \right]$$

$$F_1 = \tanh \left\{ \min \left[\max \left(2 \frac{\sqrt{k}}{0.99 \omega y}, \frac{500 \mu}{y^2 \omega} \right), \frac{4 \sigma_{\omega 2} k}{CD_{kw} y^2} \right] \right\}^2$$

$$v_t = \frac{\alpha_1 k}{\max(\alpha_1 \omega, \Omega F_2)} \quad F_2 = \tanh \left[\max \left(2 \frac{\sqrt{k}}{0.99 \omega y}, \frac{500 \mu}{y^2 \omega} \right) \right]^2$$

$$P_k = \mu S^2 \quad S = \sqrt{2 S_{ij} S_{ij}} \quad S_{ij} = \frac{1}{2} \left(\frac{\partial U_i}{\partial x_j} + \frac{\partial U_j}{\partial x_i} \right) \quad \Omega = \sqrt{2 \Omega_{ij} \Omega_{ij}} \quad \Omega_{ij} = \frac{1}{2} \left(\frac{\partial U_i}{\partial x_j} - \frac{\partial U_j}{\partial x_i} \right)$$

$$\beta^* = 0.09 \quad \alpha = 5/9, \beta = 3/40 \quad \sigma_k = \sigma_w = 2 \quad \sigma_{k2} = 1 \quad \sigma_{\omega 2} = 0.856 \quad \beta_2 = 0.0828$$

$$\text{Wall: } k = 0 \quad \omega = 10 \frac{6\nu}{\beta y_1^2}$$

3.5 Calculation Model in CFX

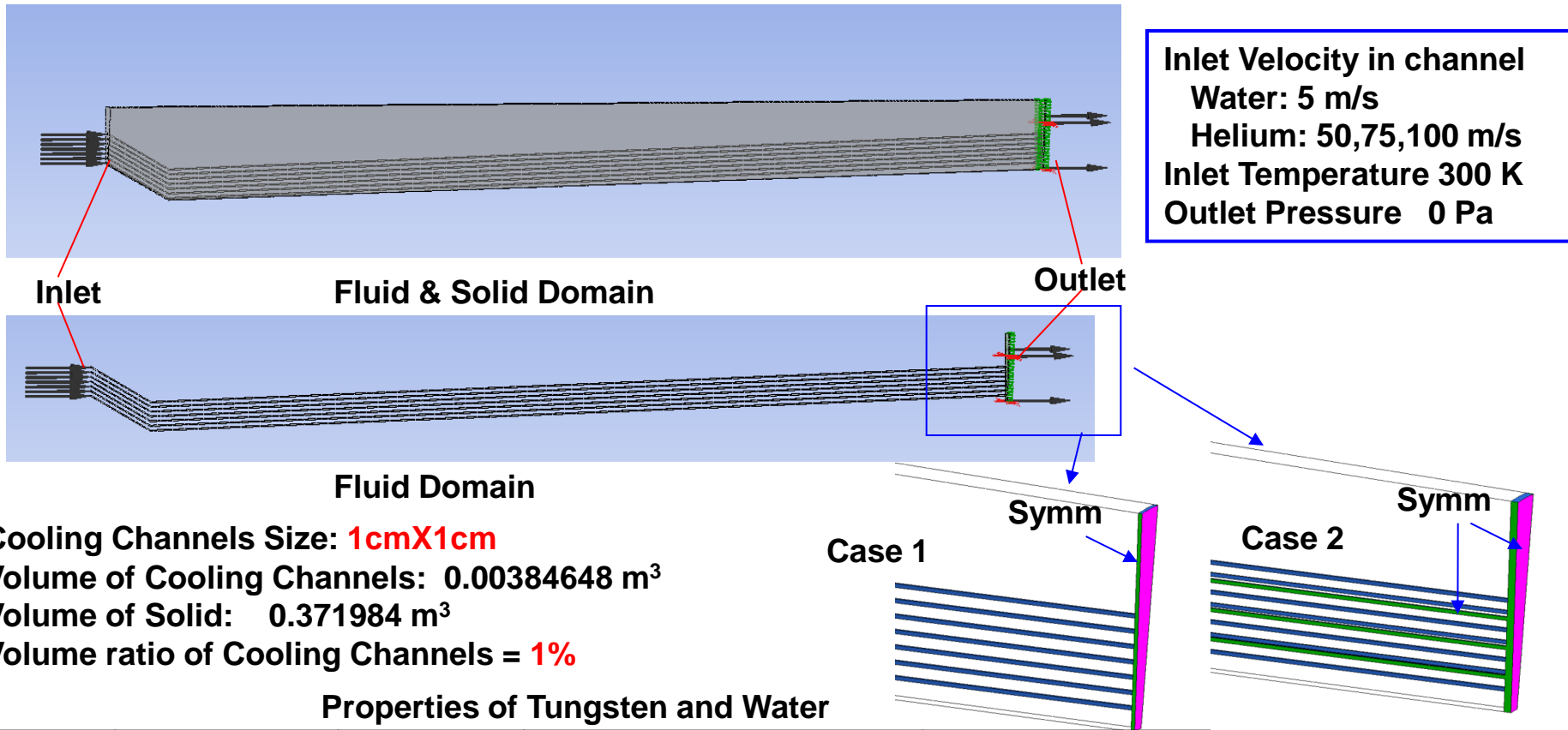

	Heat capacity (J/kg K)	Density (Kg/m ³)	Thermal Conductivity (W/m K)	Viscosity (Kg/m s)
Tungsten	134	19000	120	
Water	4181	997	0.6069	8.8×10 ⁻⁶

3.6 Heat source in CFX

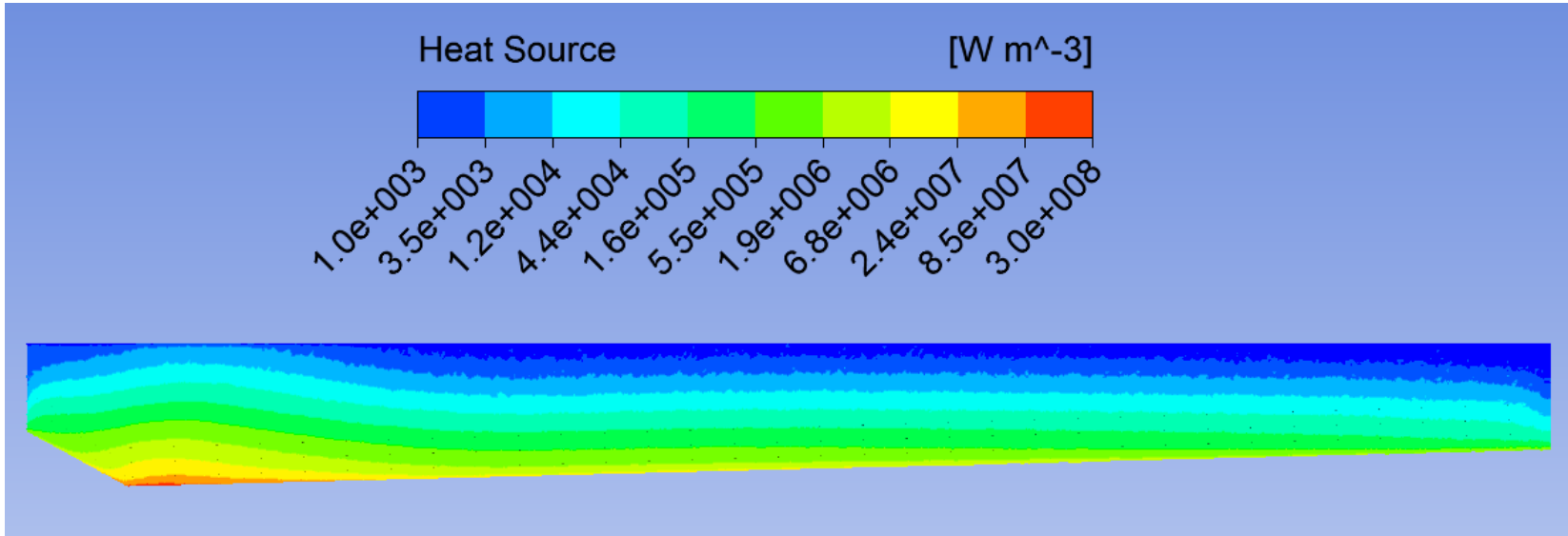

Heat load of shielding @Beam Power= 165053W*60=9.9MW
Max volumetric heat source=2.2x10⁸ W m⁻³

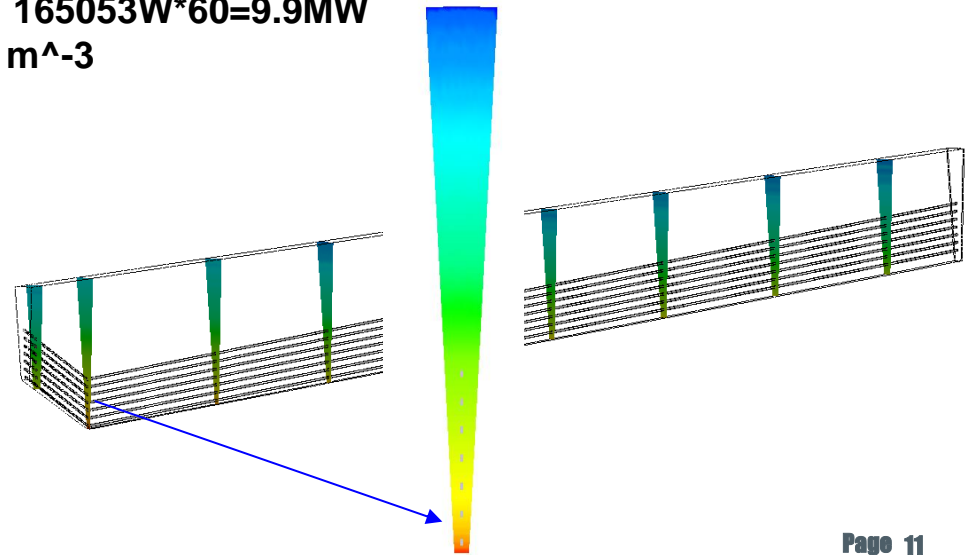
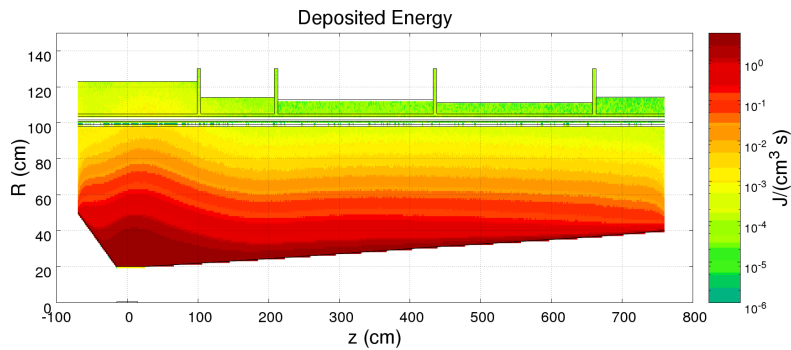

3.7 Results: case 1, water, 5 m/s

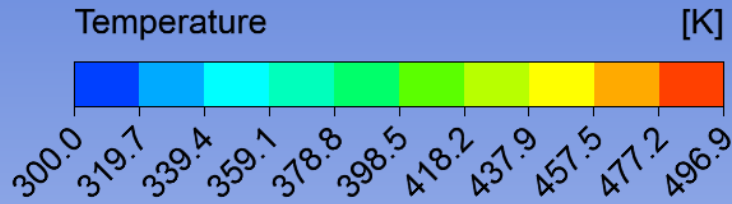

Pressure Drop= 0.8 MPa

Outlet T=311.7 K $\Delta T=11.7$ K

Mass flow rate= $7 \times 997 \text{ kg/m}^3 \times 5 \text{ m/s} \times 0.0001 \text{ cm}^2 = 3.49 \text{ kg/s}$

Total mass flow rate @ Shielding= $206 \text{ kg/s} = 744 \text{ m}^3/\text{h}$

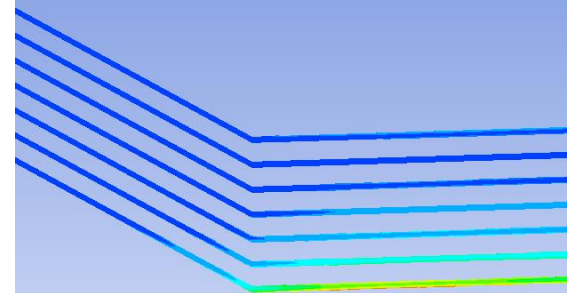
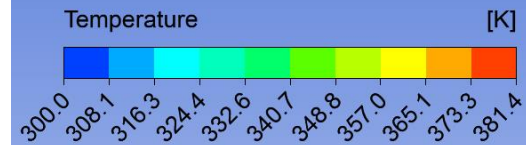

3.8 Properties of Helium

Density @300 K against Pressure

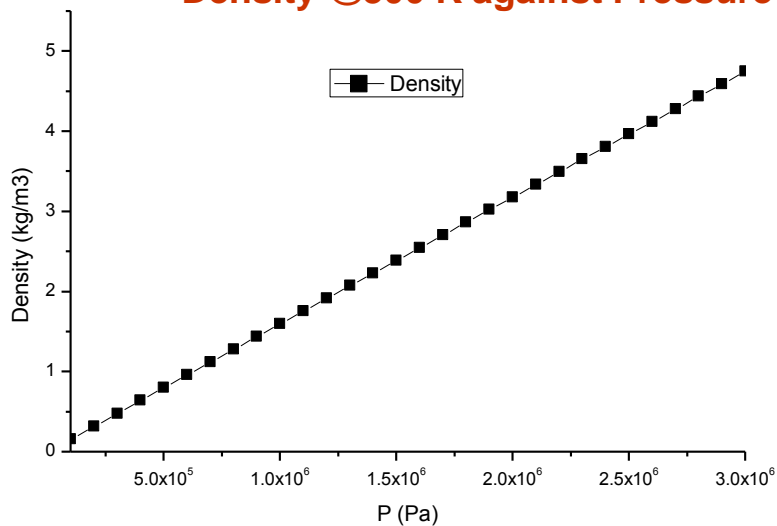

Density @3 Mpa against Temperature

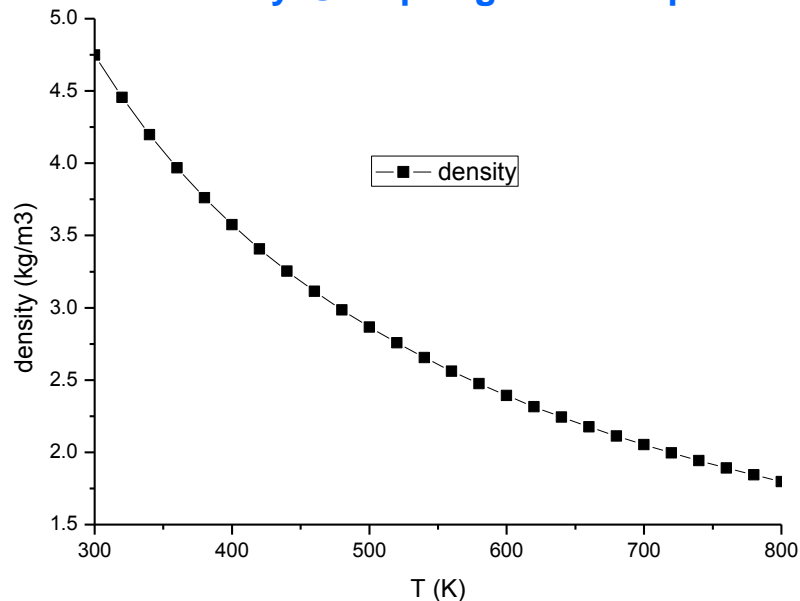

Special Heat Capacity @3 Mpa

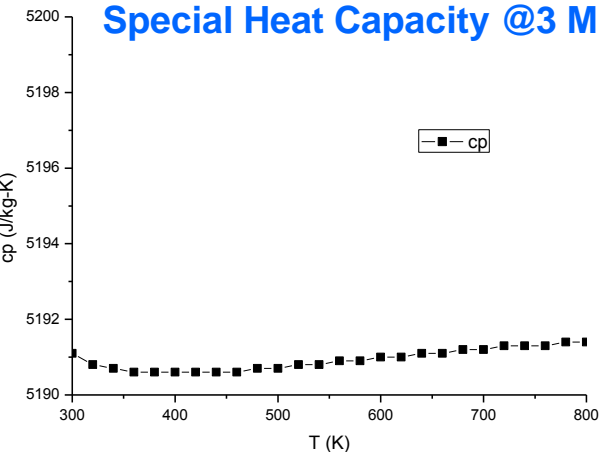

Viscosity @3 Mpa

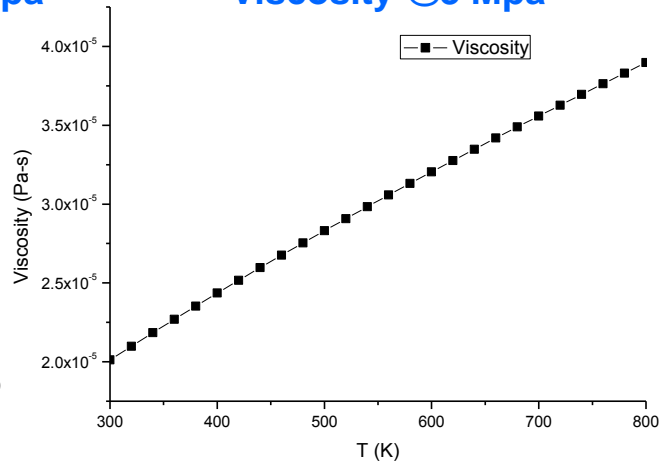

Heat Conductivity @3 Mpa

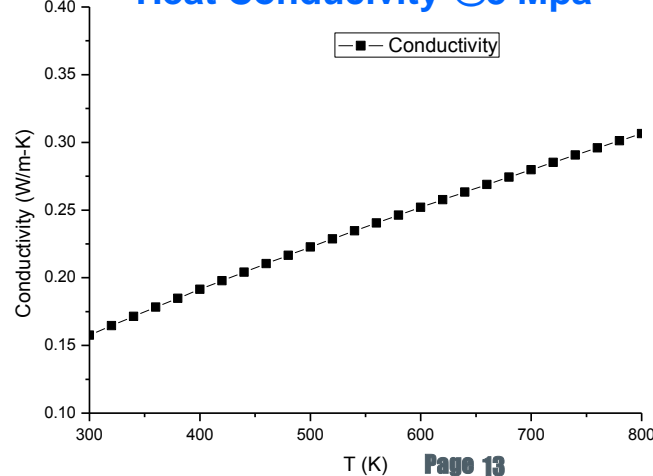

3.9 Comparison of Pressure: case 1, Helium, 100 m/s

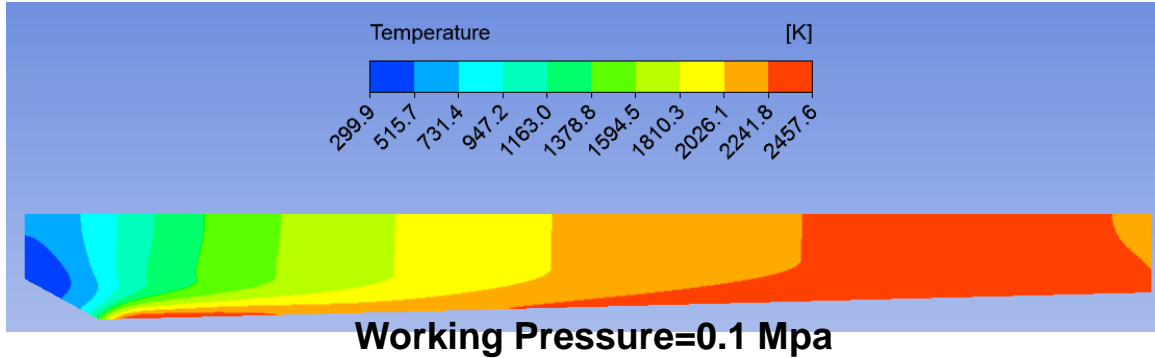

T@outlet=2204.2 K
T@outlet-T@inlet=1904.2 K
Max T=2184.5 °C
Pressure drop=0.04 Mpa

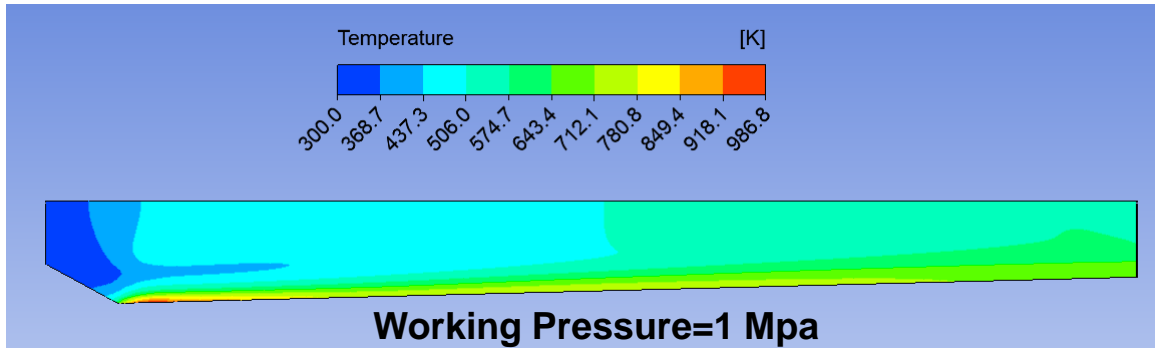

T@outlet=617.5 K
T@outlet-T@inlet=317.5 K
Max T=713.7 °C
Pressure drop=0.48 Mpa

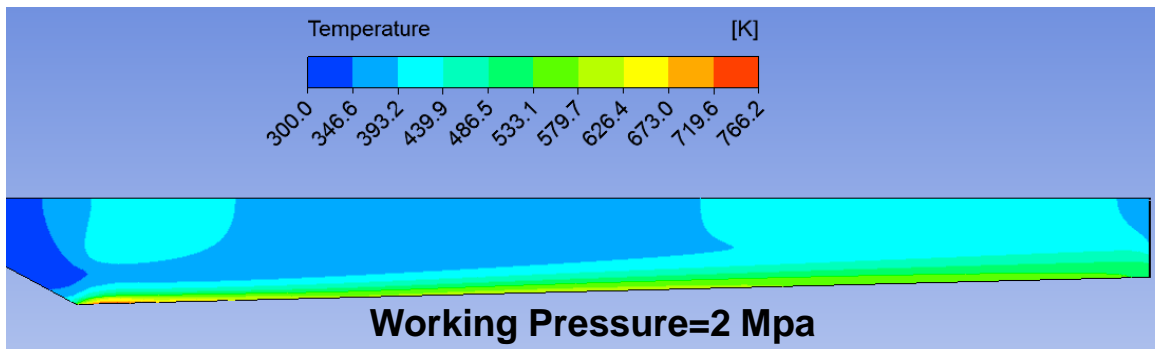

T@outlet=450.4 K
T@outlet-T@inlet=150.5 K
Max T=493.1 °C
Pressure drop=0.83 Mpa

3.10 Comparison of veolicity: case 1, Helium, 3Mpa

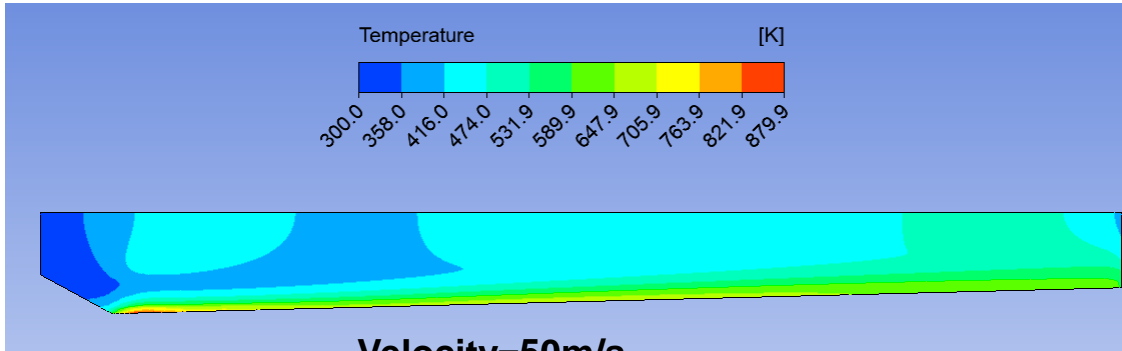

Velocity=50m/s

$T@outlet=519.3[K]$
 $T@outlet-T@inlet=219.3[K]$
 Max T=603 °C
 Pressure drop=0.54Mpa

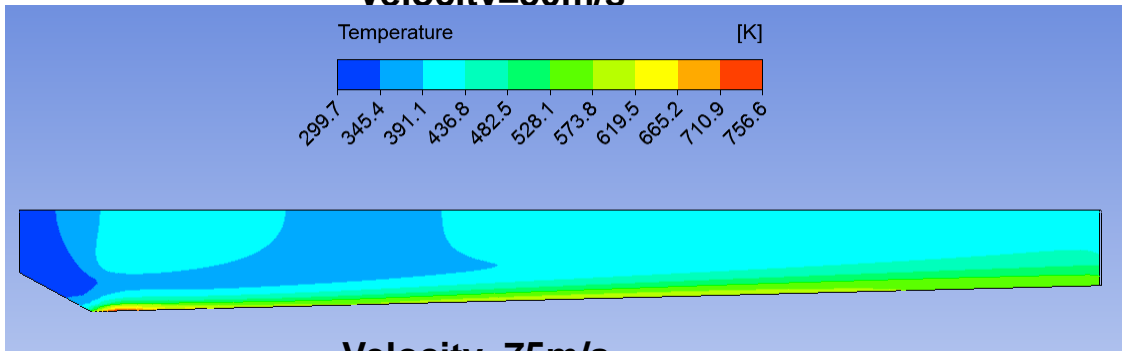

Velocity=75m/s

$T@outlet=479.2[K]$
 $T@outlet-T@inlet=179.3[K]$
 Max T=483 °C
 Pressure drop=1Mpa

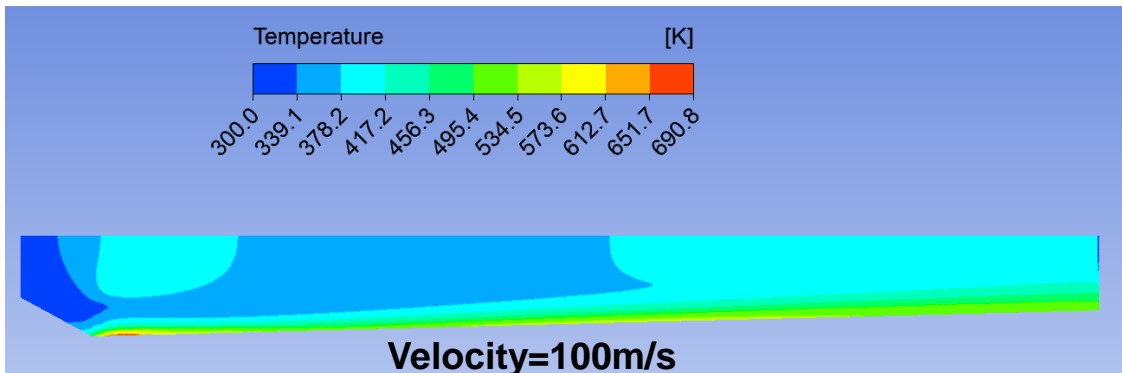

Velocity=100m/s

$T@outlet=428.4[K]$
 $T@outlet-T@inlet=128.4[K]$
 Max T= 418 °C
 Pressure Drop=1.5 Mpa

3.11 Comparison of Case 1 & Case 2: Water, 5m/s

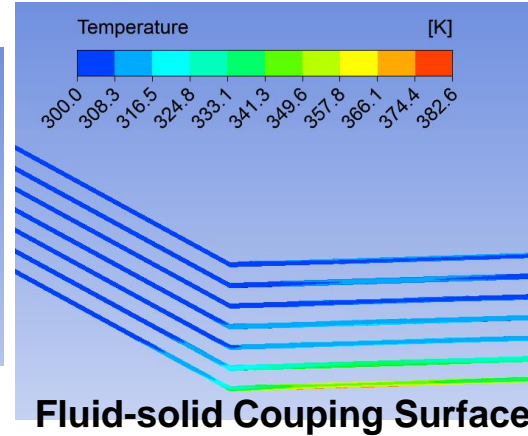
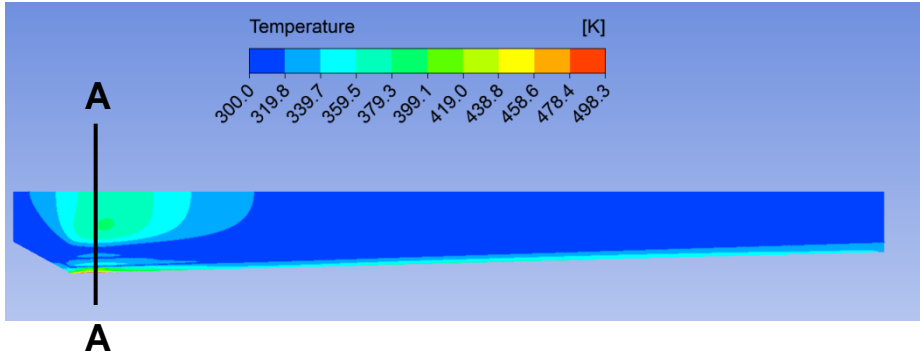

Case 2

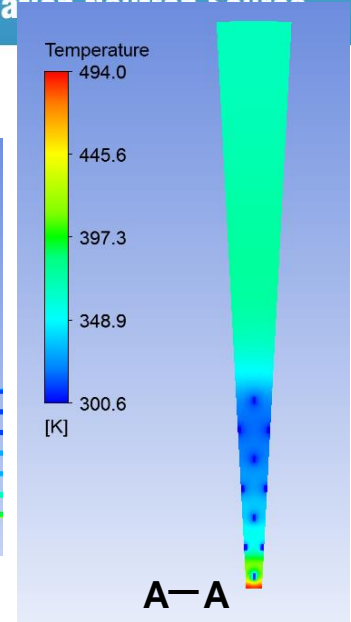

A-A

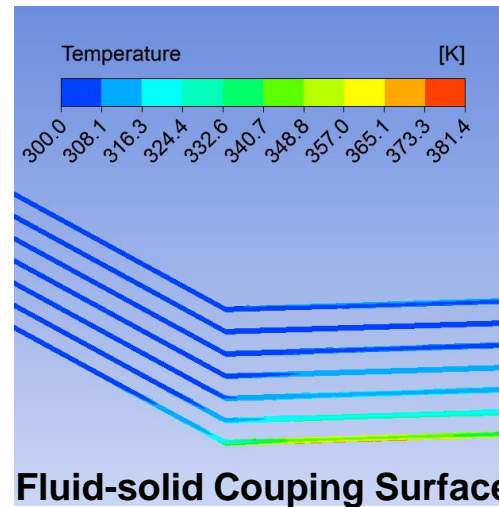

Case 1

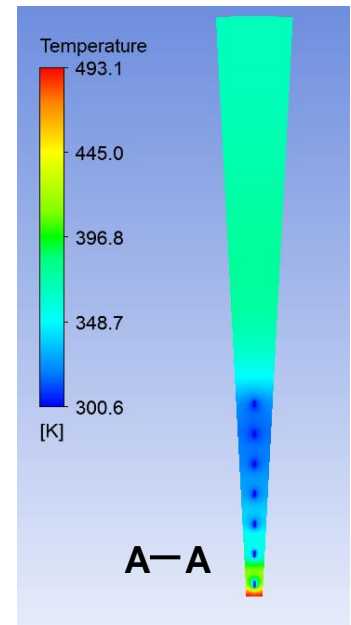

A-A

- For the high heat conductivity of water, the maximum temperature values of shielding and water in Case 1 and Case 2 are nearly same, but the temperature distribution is slightly different.
- The first wall thickness (position of No.1 channel) determines the maximum temperature, in this study, we use 1 cm.

3.12 Comparion of Case 1 & Case 2: Helium, 100m/s, 3Mpa

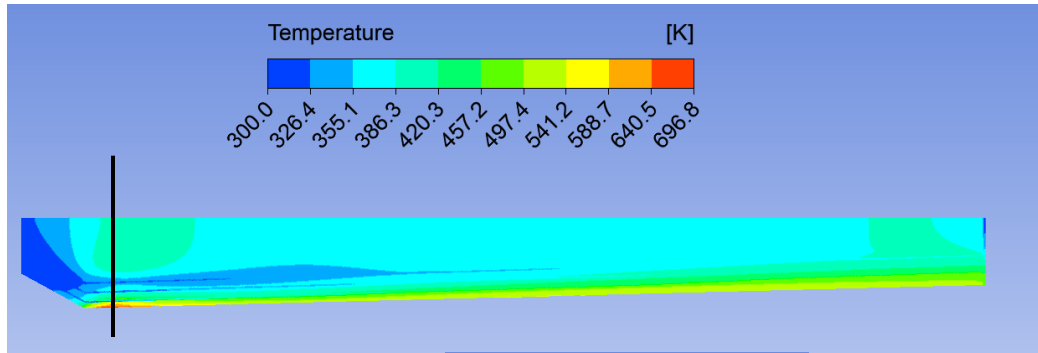

Mass flow rate= 0.29879 [kg s⁻¹]
Total flow rate @Shielding=17.92kg/s

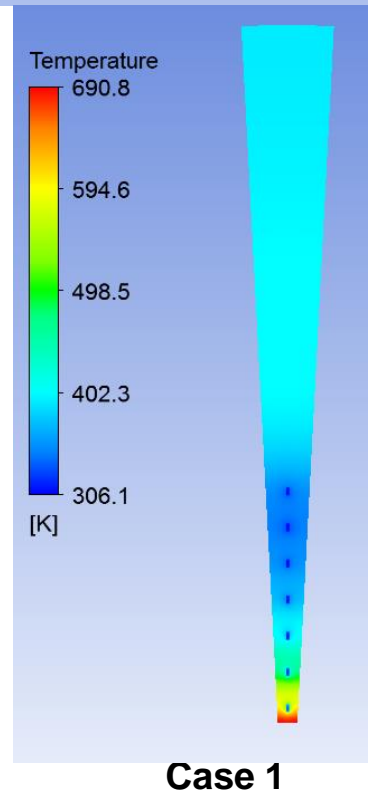
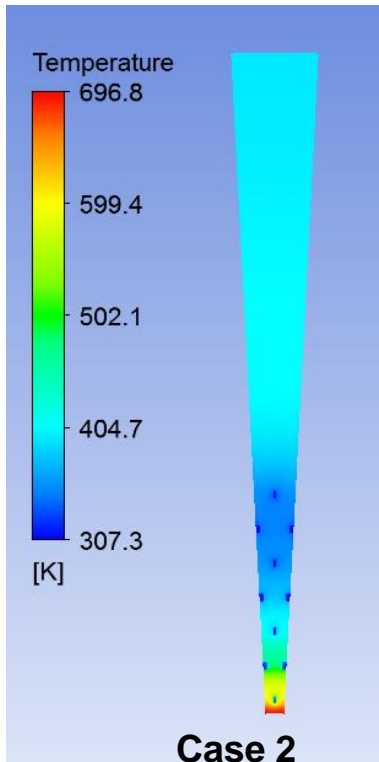

The maximum temperature of shielding in Case 2 is higher than Case 1 at current conditions. The cooling channel distribution effect can not be ignored due to cold helium.

Conclusion

- From the Fluka calculation, the total heat load of shielding is about 10 MW and the maximum volumetric heat is above 100 W/cc , which is a challenge work for cooling design .
- Multiple Rows of Mini-Channel(MRMC), the shape of which is like a fold line to remove the highest volumetric heat, with reasonable channel size(1 cmX1 cm) and first wall thickness(1 cm), and the cooling direction of channel from front to rear, are preliminary ideals in the cooling structure design, and can minimize irradiation damage to magnets.
- For the corrosion in high temperature, tungsten should be clad with tantalum, and the coolant water should be kept in single phase, the velocity should be very high.
- With MRMC and low first wall thickness, helium is a good coolant choice with high pressure and high velocity.
- Different channel distributions with constant first wall thickness has a different effects on the maximum temperature of shielding based due to the coolant thermal properties.
- It is possible to remove the high heat load and high volumetric heat on shielding at MOMENT using water or high pressure helium with MRMC.

Thank you for your attention