

# Displacement Damage and Gas Production Data for ESS Structural Materials

*U. Fischer, A. Yu. Konobeyev, M. Majerle<sup>(\*)</sup>, P. Vladimirov, B. Weinhorst*

Karlsruhe Institute of Technology

*(\*) Nuclear Physics Institute, Rez, CR (permanent address)*

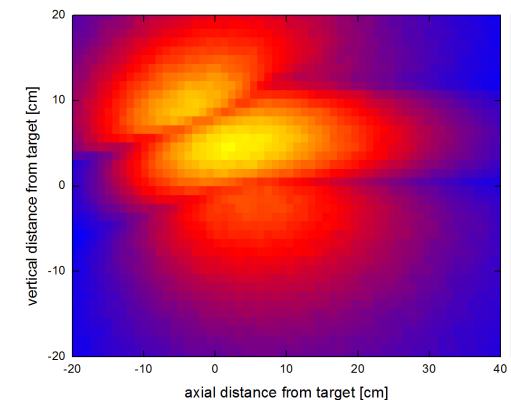
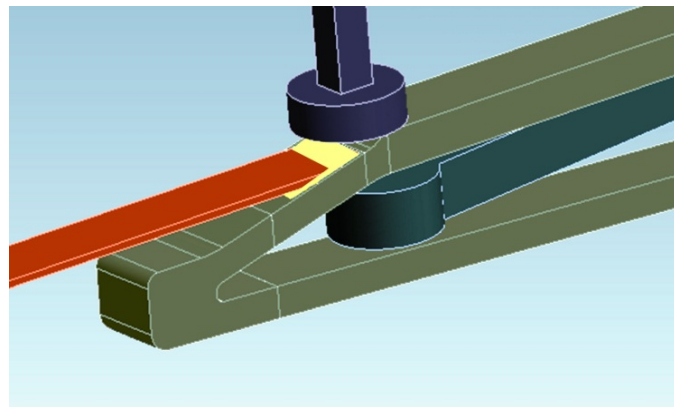
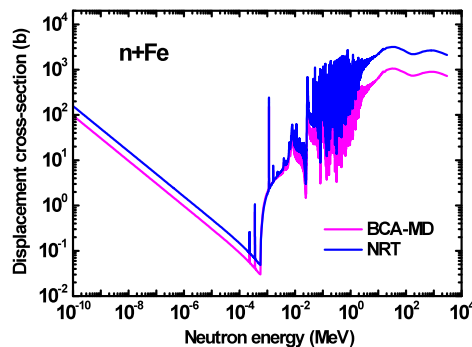

# Content

- Background
- Data evaluation methodology (KIT)
- Displacement damage and gas production cross-section data
- Fe, Cr, Ni & others for n & p induced reactions up to 3 GeV
- Application to ESS windowless liquid metal target
- Conclusions

# Background

- ESS target and structural materials subjected to intense neutron and proton irradiation
- Materials properties deteriorated due to displacement damages and gas generation
- Very few data available for materials and energy range relevant to ESS
- Evaluation effort at KIT for providing data of n & p induced reactions up to 3 GeV
- Focus on Fe, Cr & Ni

# Displacement damage cross-section

$$\sigma_d(E_p) = \sum_T \int_{E_d}^{T_i^{\max}} \frac{d\sigma(E_p, Z_T, A_T, Z_i, A_i)}{dT_i} \eta(T) N_{\text{NRT}}(T_i, Z_T, A_T, Z_i, A_i) dT_i$$

$d\sigma/dT$  : recoil energy distribution

$E_d$  : effective threshold displacement energy

Defect production efficiency  $\eta(T) = \frac{N_D}{N_{\text{NRT}}}$

$N_D(T)$  : number of Frenkel pairs produced by PKA (MD, BCA, experiment)

---

*MD = Molecular Dynamics*  
*BCA = Binary Collision Approximation*

# NRT model

*M.J.Norgett, M.T.Robinson, I.M.Torrens, Nucl. Eng. Des. 33 (1975), 50*

Number of defects produced by PKA

$$N_{\text{NRT}}(T) = \frac{0.8}{2E_d} T_{\text{dam}}$$

T: PKA energy

$$T_{\text{dam}}(T) = \frac{T}{1 + k \left( 3.4008 \varepsilon^{1/6} + 0.40244 \varepsilon^{3/4} + \varepsilon \right)}$$

Available experimental data and MD simulations show pronounced differences with NRT predictions

Typical  $\eta(T)$  values: 0.5 (Al), 0.3 (Fe), 0.3 (Cu)

# Defect production calculation – KIT approach

Combined BCA-MD approach for the calculation of the number of stable displacements in atom lattices

Transition from BCA to MD at “critical” kinetic energy  
( $T_{\text{crit}}$ )

$T < T_{\text{crit}}$  : MD  
 $T > T_{\text{crit}}$  : BCA

$T_{\text{crit}}$  typically between 30 – 60 keV

KIT codes IOTA and CASCADE

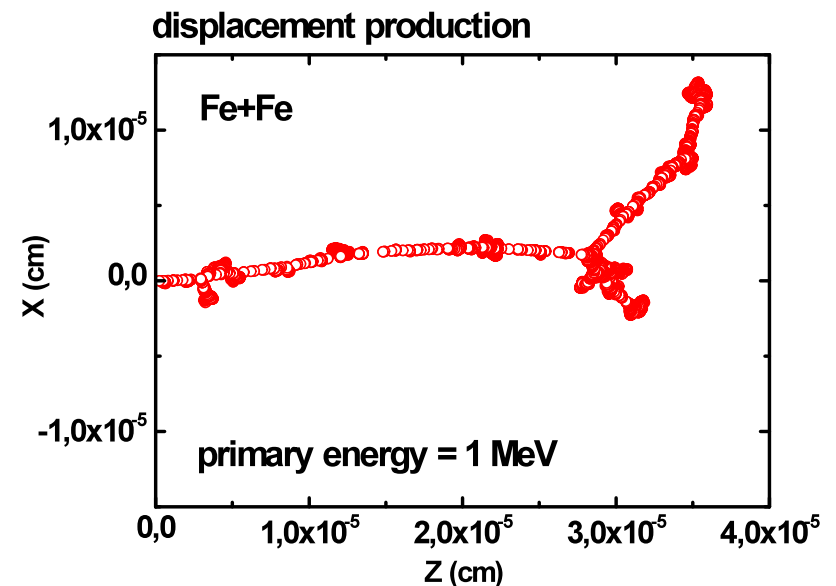

# Example: $N_D/N_{NRT}$ for iron

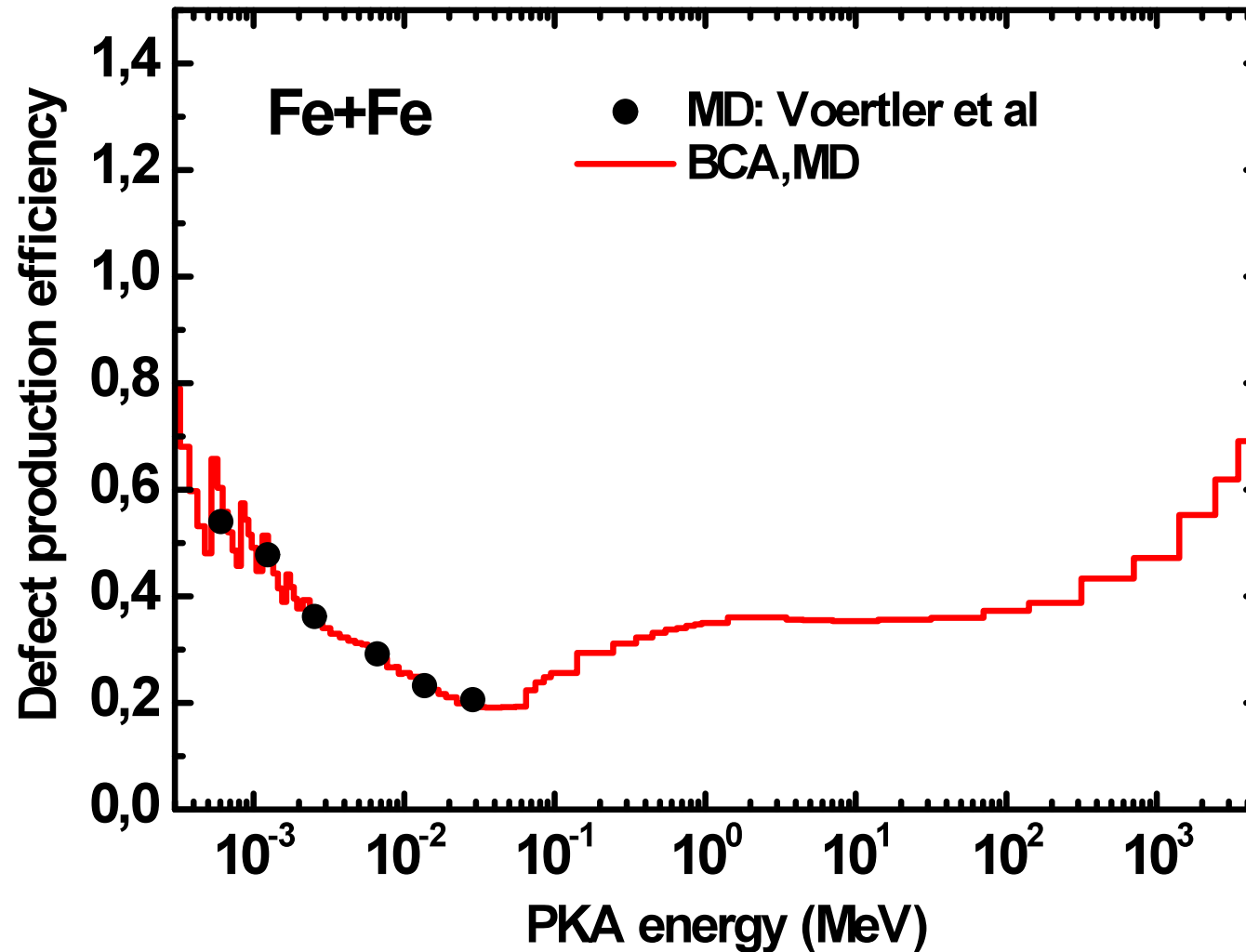

# Nucleon elastic scattering

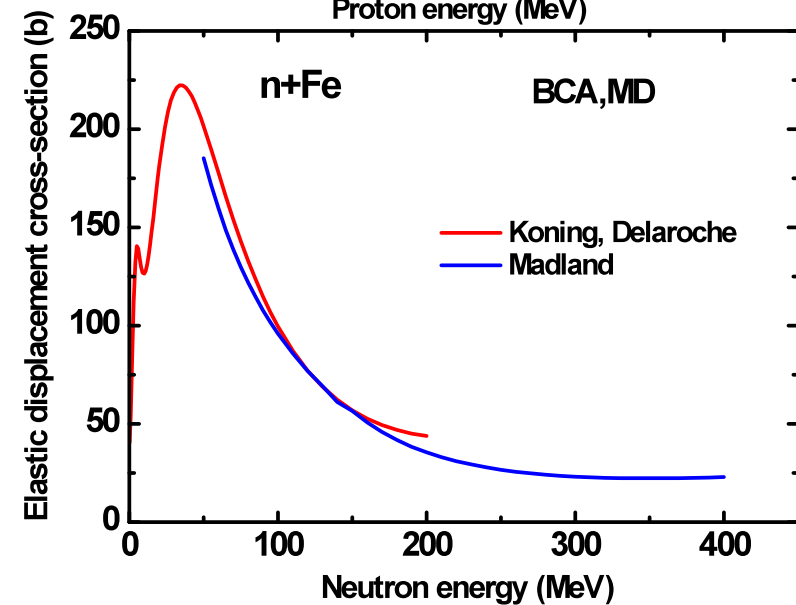
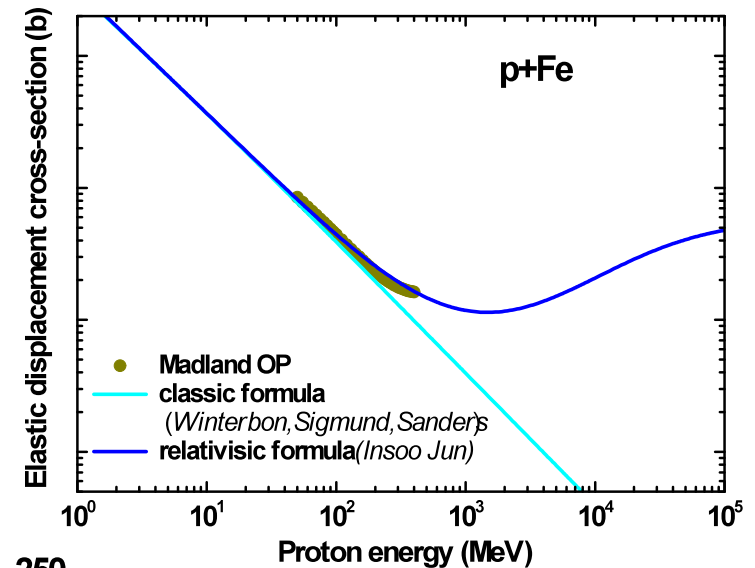
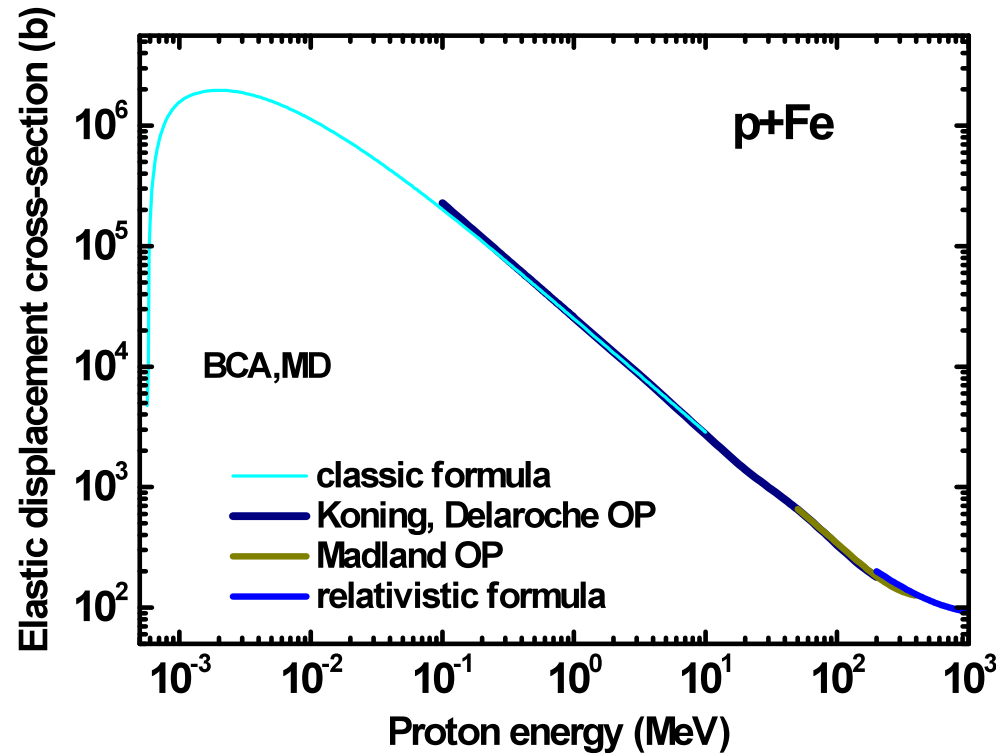

- Optical potentials of Koning, Delaroche and Madland up to 400 MeV
- Relativistic approach above 400 MeV



# Non-elastic scattering

## Different models & codes

MCNPX: INC+PE+EQ

INC: Bertini, ISABEL, CEM03, INCL4

EQ: Dresner, ABLA

CASCADE (JINR, KIT): INC+EQ

DISCA-C (KIT): INC(+clusters)+EQ

TALYS : PE (exciton model) +EQ (H-F)

HMS ALICE : Hybrid model +EQ

GNASH: PE (exciton model) +EQ (H-F)

## Evaluated displacement cross-section :

$$\sigma_{\text{displ}} = \sum_{m=1}^M w_m \sigma_{\text{displ},m}$$

# Non-elastic scattering (cont'd)

Example: Displacement cross-sections (b) for non elastic interactions of 0.6 GeV neutrons and protons with  $^{56}\text{Fe}$ . Calculation of recoil spectra and displacement cross-sections using equally weighted models

Nuclear model	Neutrons	Protons
Bertini/Dresner	807	727
Bertini/ABLA	864	775
ISABEL/Dresner	815	732
ISABEL/ABLA	857	776
CEM03	781	712
INCL4/Dresner	956	849
INCL4/ABLA	1002	894
CASCADE	796	717
DISCA-C	870	786
<b>Average value</b>	<b>861 ± 75</b>	<b>774 ± 62</b>

# Evaluated Fe displacement damage cross-sections up to 3 GeV

Neutron induced

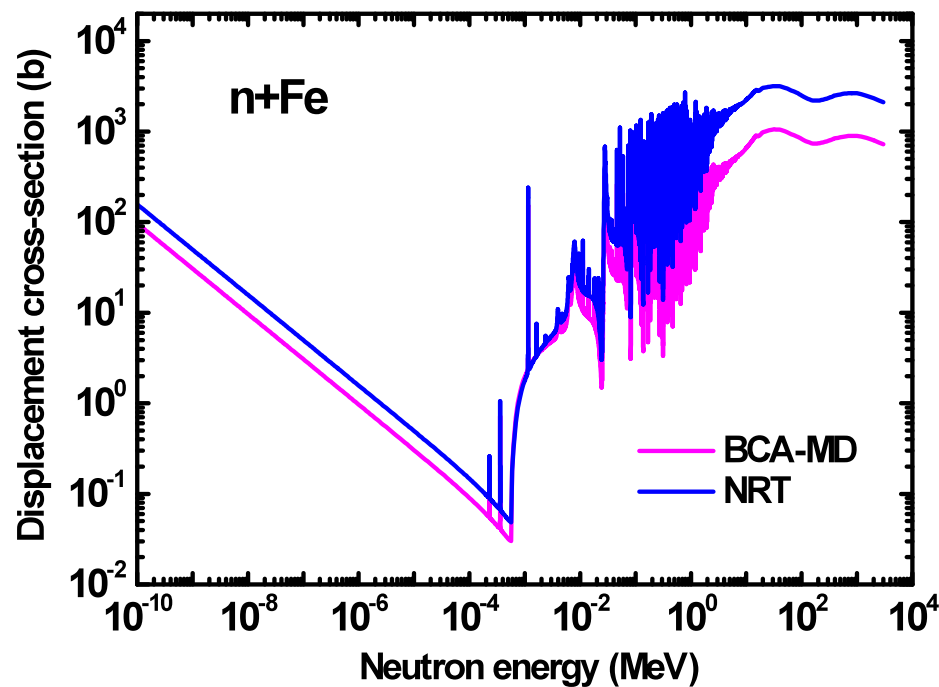

Proton induced

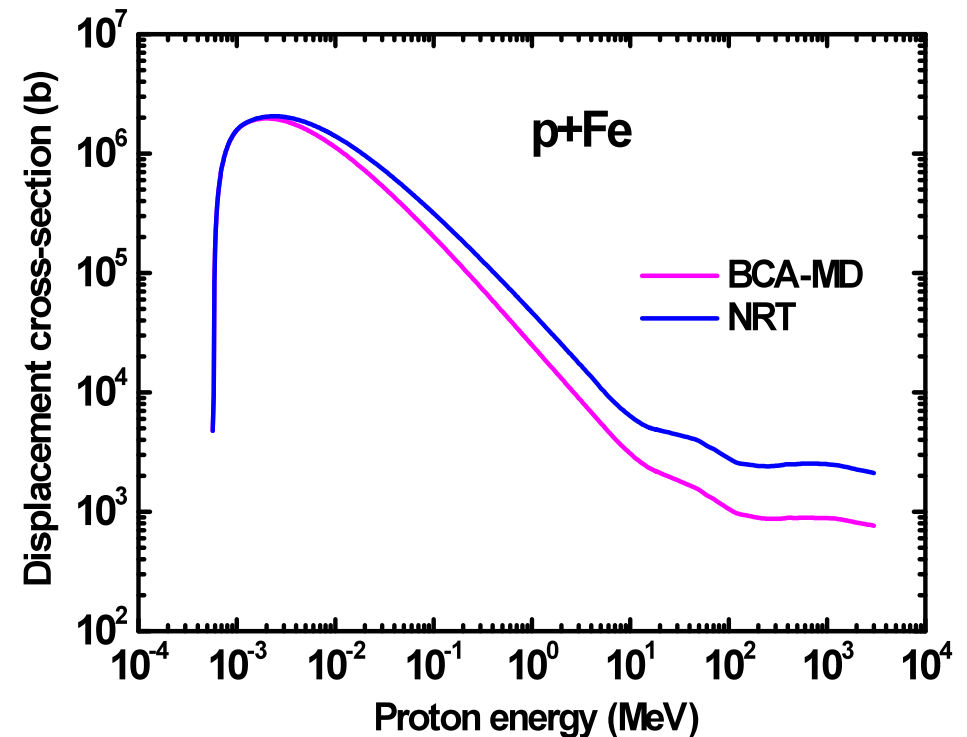

# Evaluated Cr displacement damage cross-sections up to 3 GeV

Neutron induced

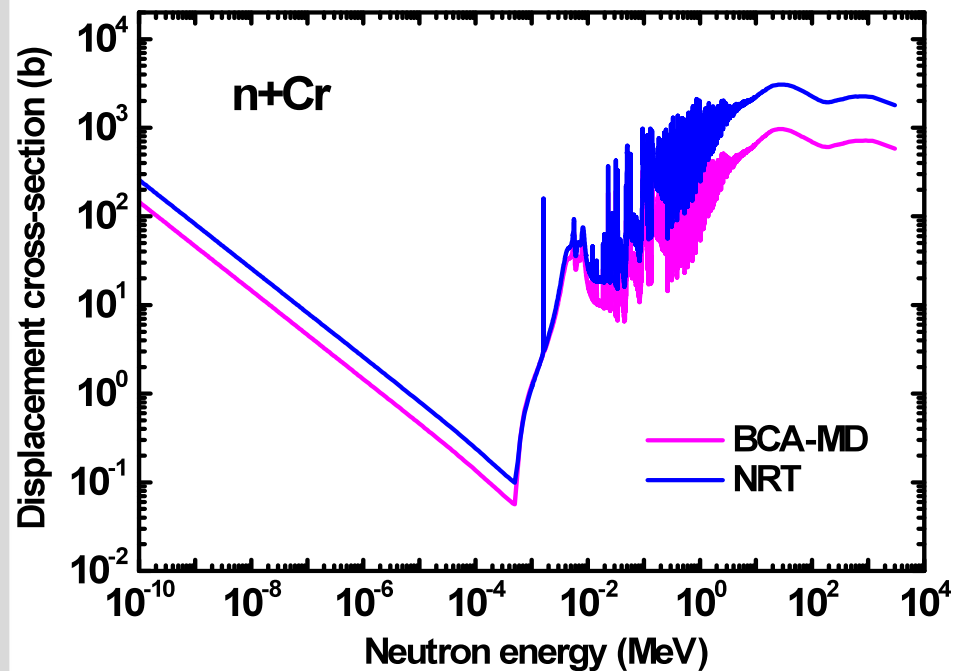

Proton induced

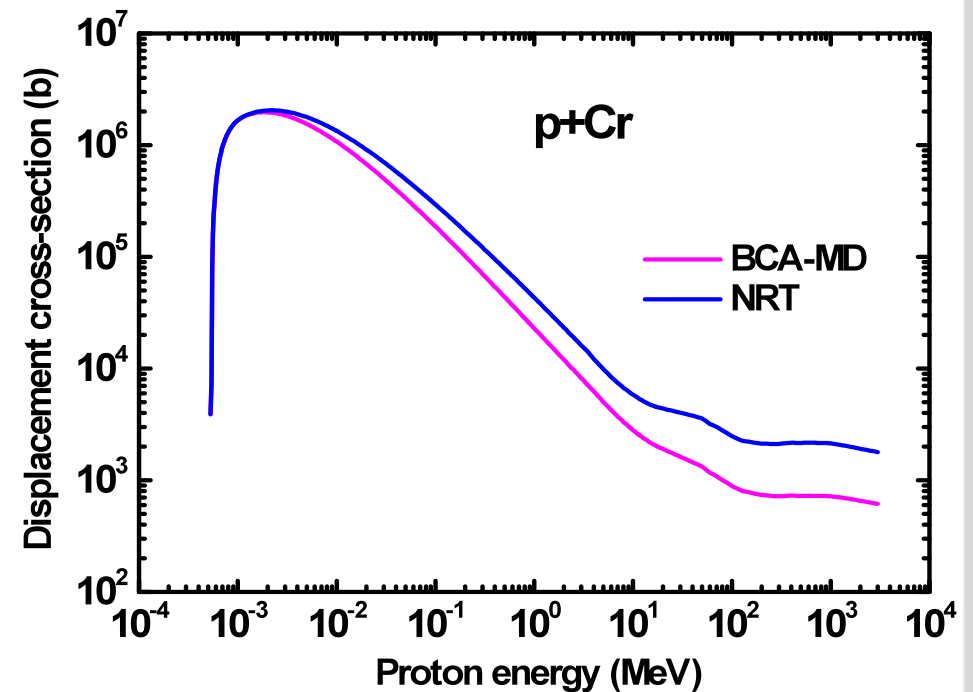

# Evaluated Ni displacement damage cross-sections up to 3 GeV

Neutron induced

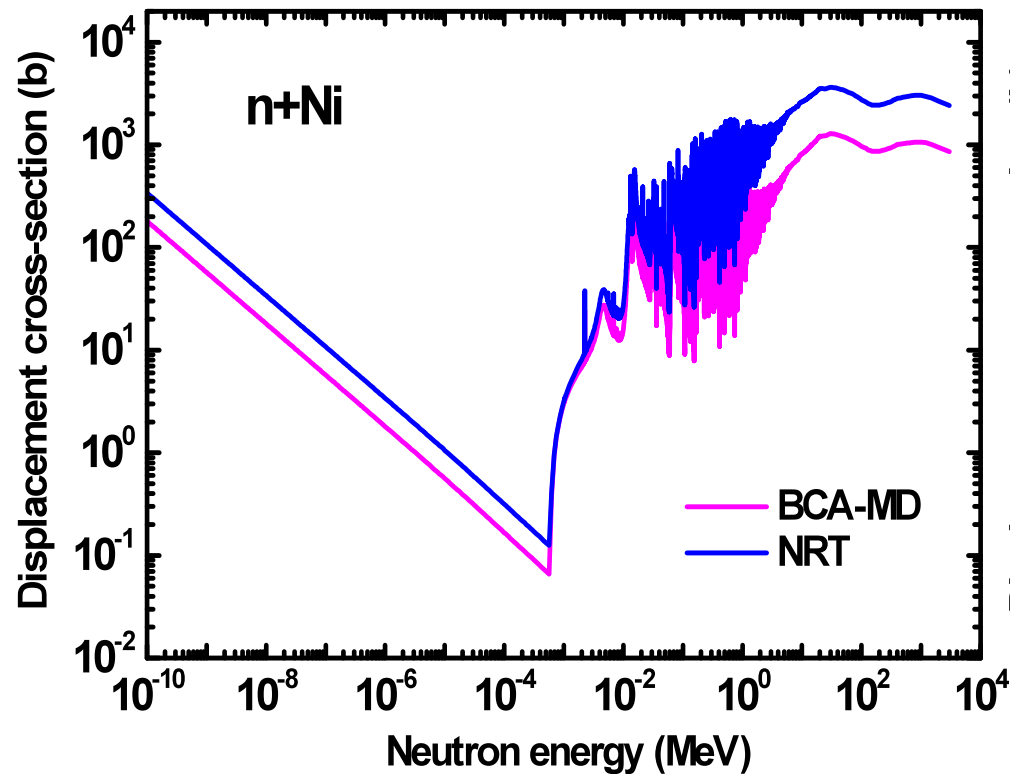

Proton induced

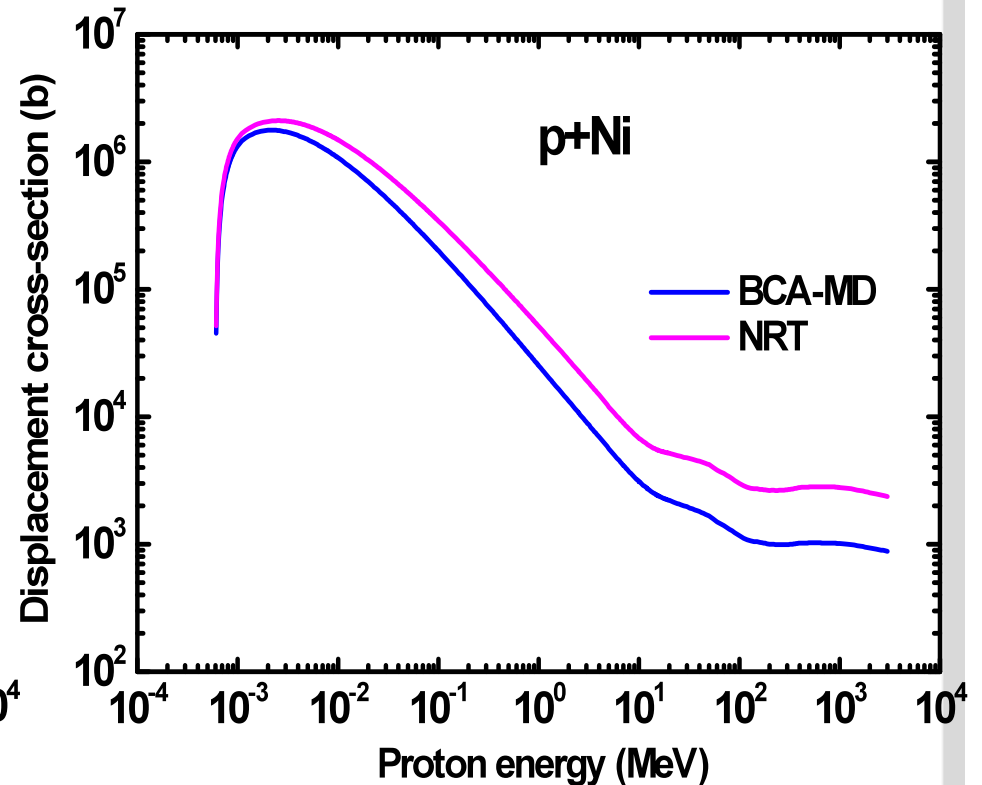

# Gas production cross-sections

## Proton-, deuteron-, triton, $^3\text{He}$ -, $^4\text{He}$ - production

### Experimental data

EXFOR, JINR compilation (1972), and more

### (p,x) reactions

Fe, Ni: 24 measurements

Cr: K.Goebel et al, CERN (1964)

### Data correction

Cutoff energy: Bertrand F.E., Peelle R.W. (1973)

Spectrum: Herbach C.-M. et al (2006)

# Calculations

ALICE/ASH (KIT) : GDH(+non-equilibrium cluster emission) +EQ

TALYS (NRG): PE exciton model +EQ (H-F)

DISCA-C (KIT): INC(+clusters)+EQ

CASCADE (JINR, KIT): INC(+improved coalescence model) +EQ

MCNPX models: for illustration purposes only

## Evaluation ...

**... comes later**

# MCNPX model calculations

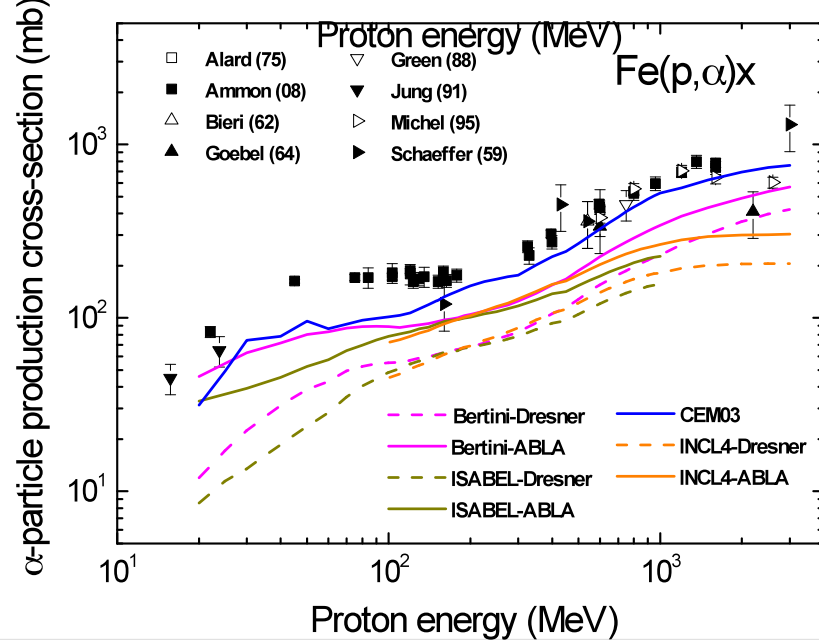
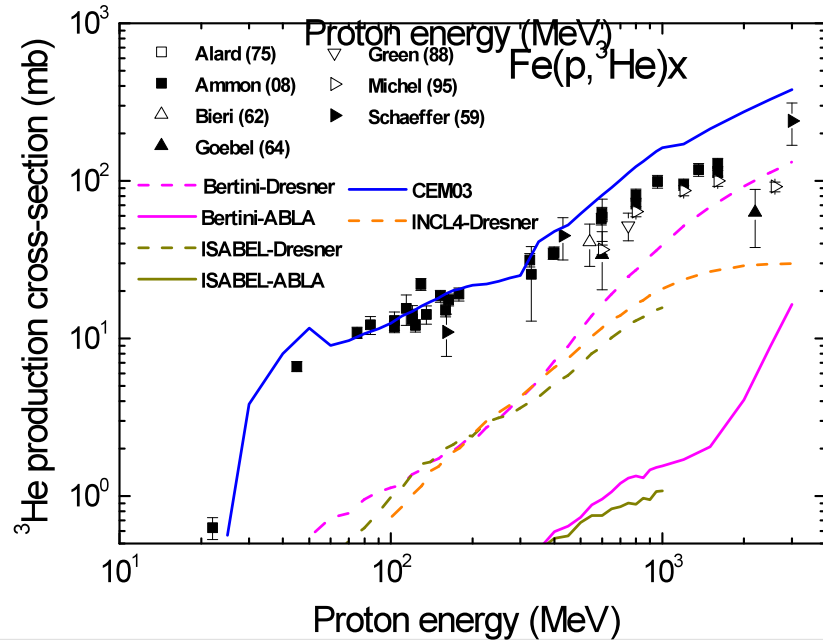
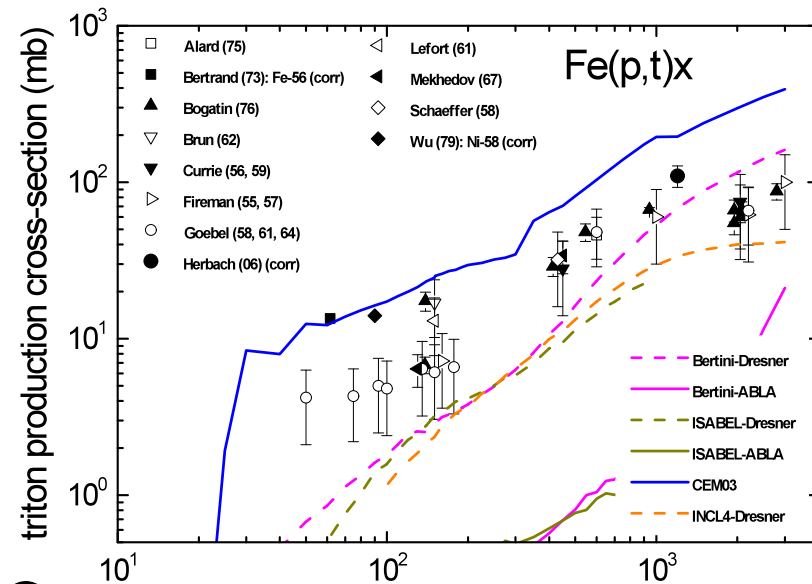
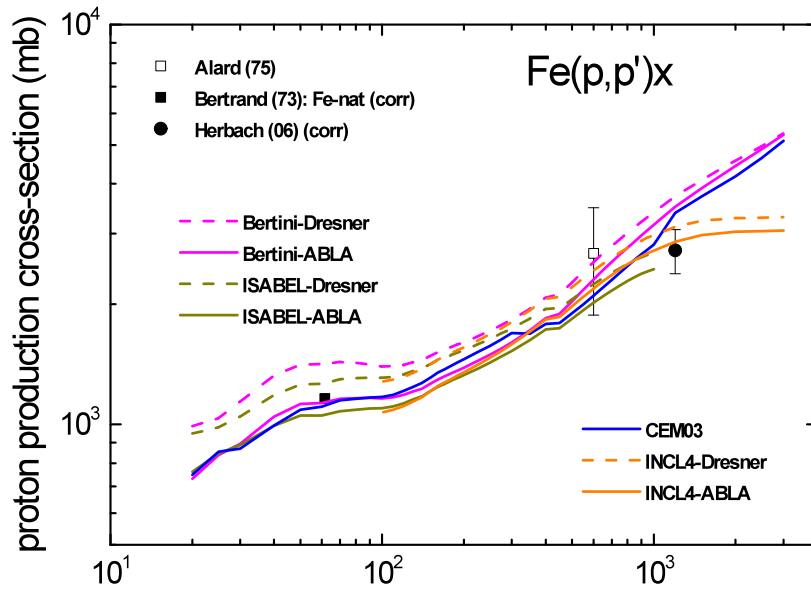



# Examples of available evaluations and model calculations

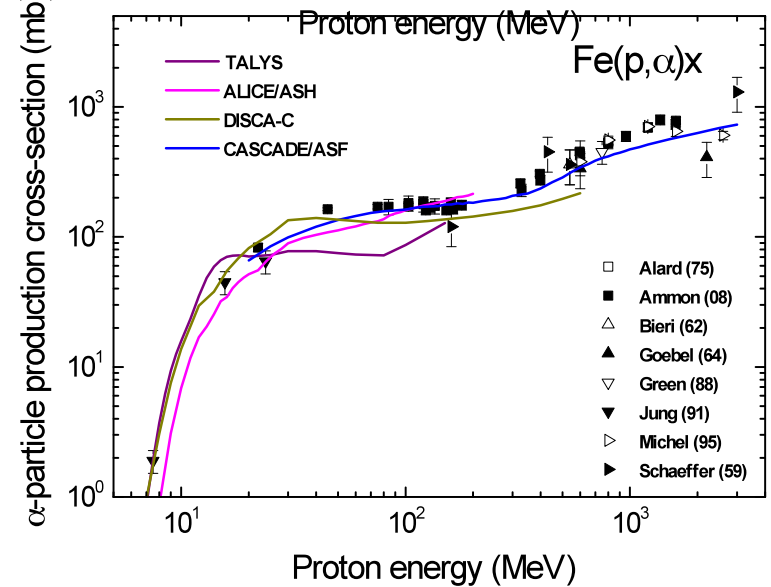
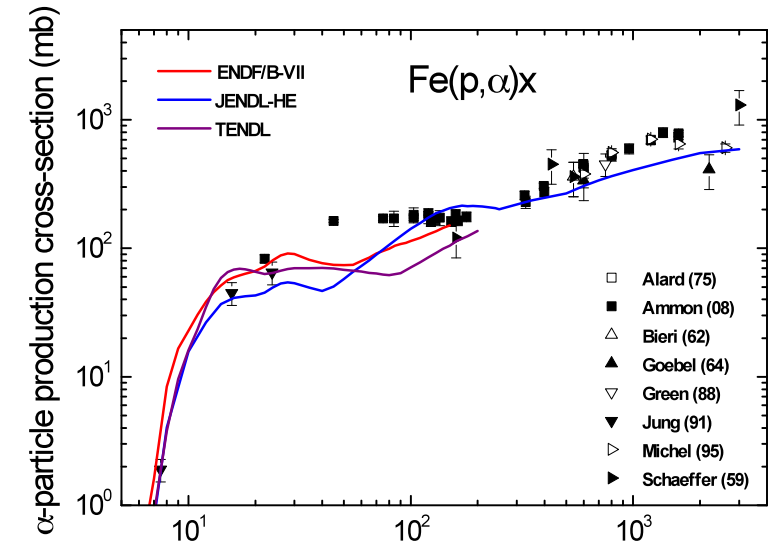
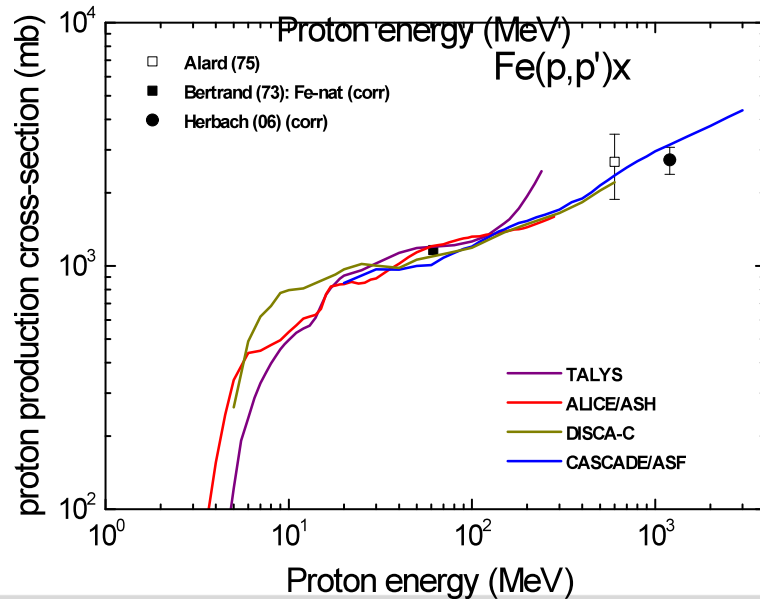
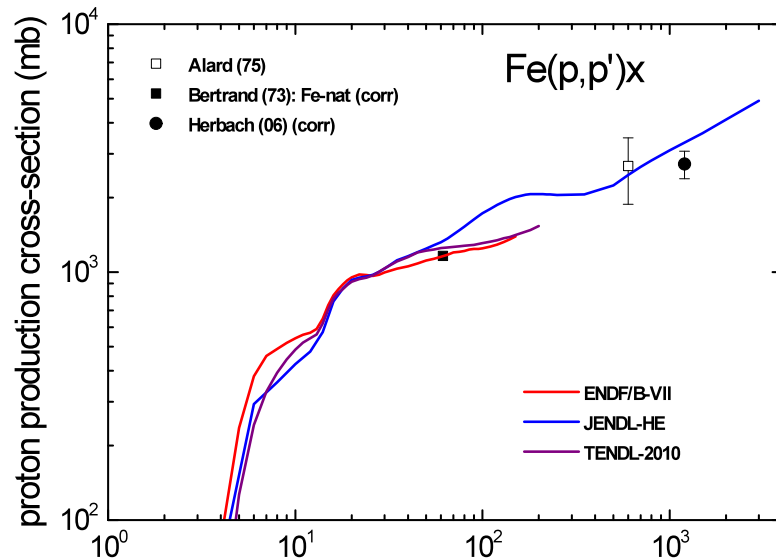

# More model calculations ...

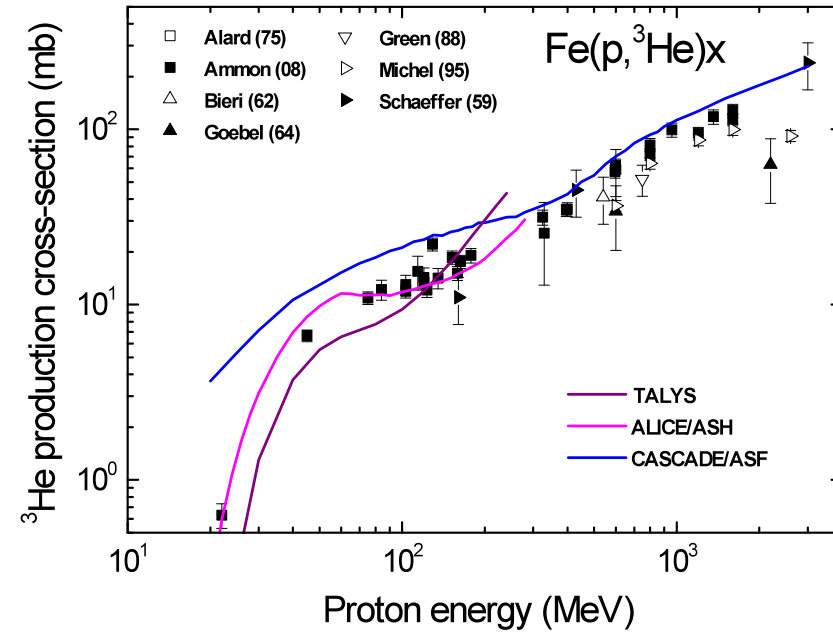
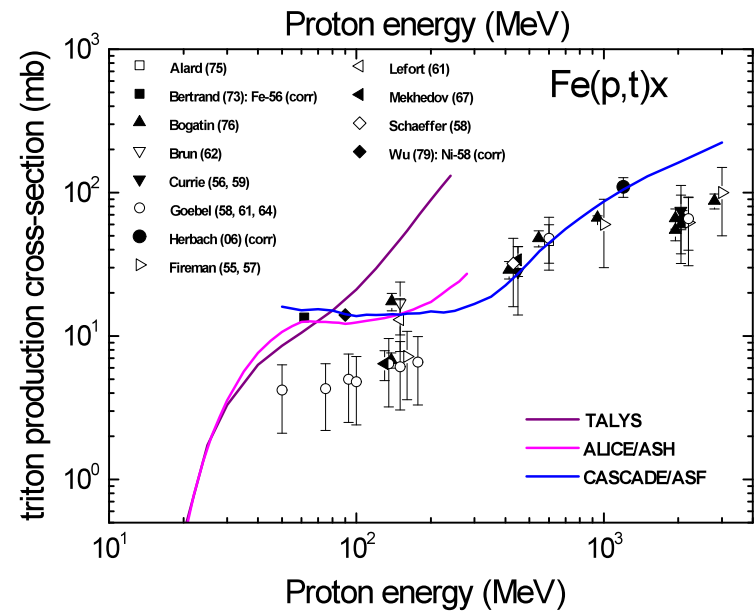
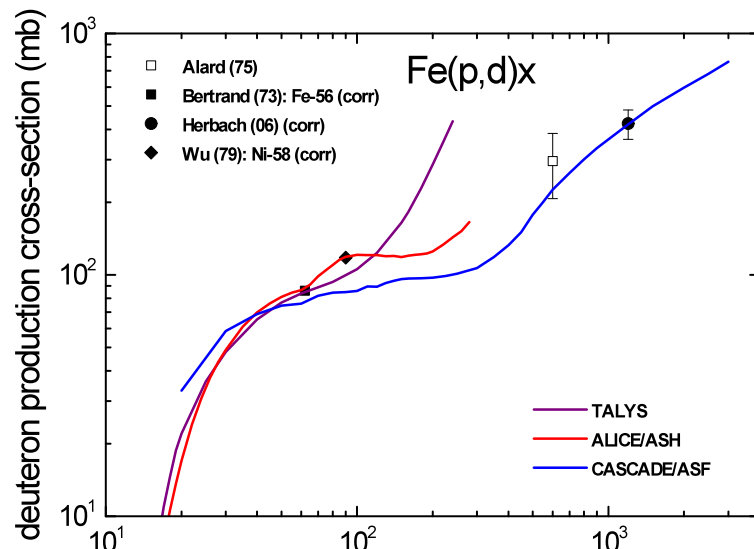

# KIT evaluated cross-section data

## I. Theoretical data

ALICE/ASH, CASCADE

TALYS: up to several MeV

## II: Experimental data

## III. Evaluated data = final data

BEKED code system (KIT)

Uncertainties & co-variance information

Generalised Least Square Method (GLSM) +

Unified Monte Carlo (UMC) of D. L. Smith.

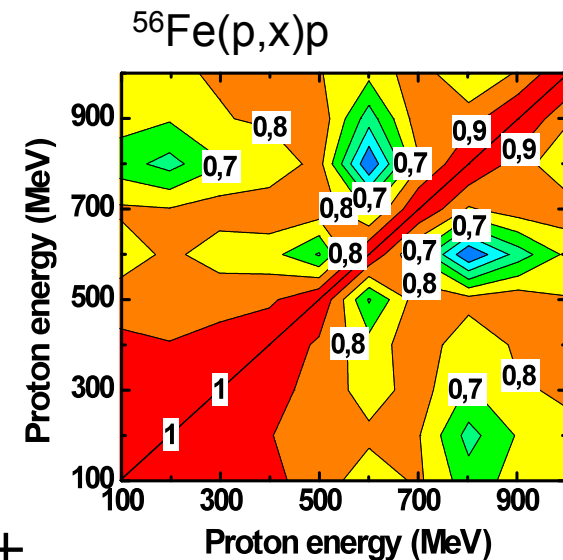

# KIT evaluated data - examples

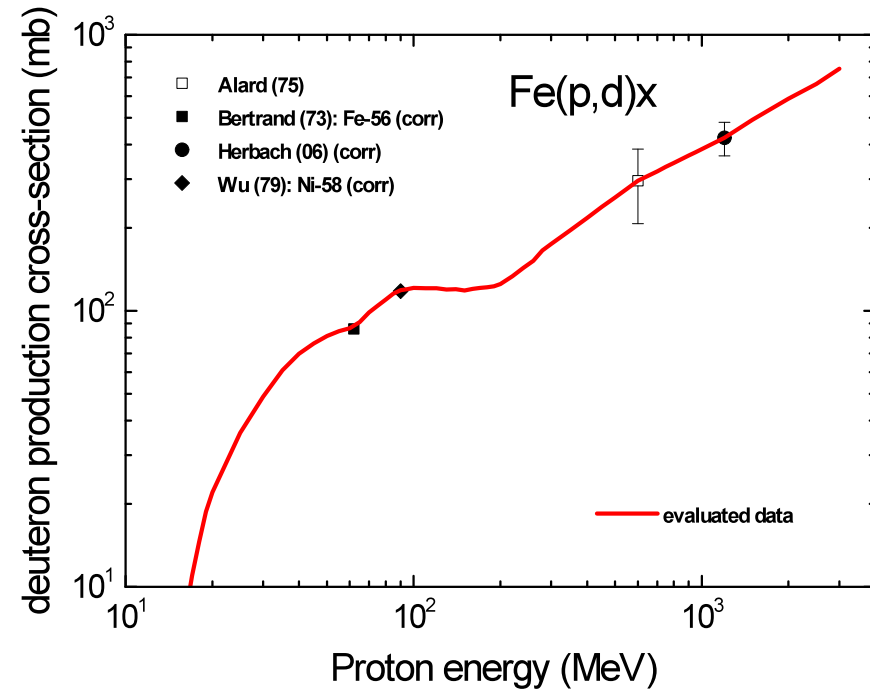
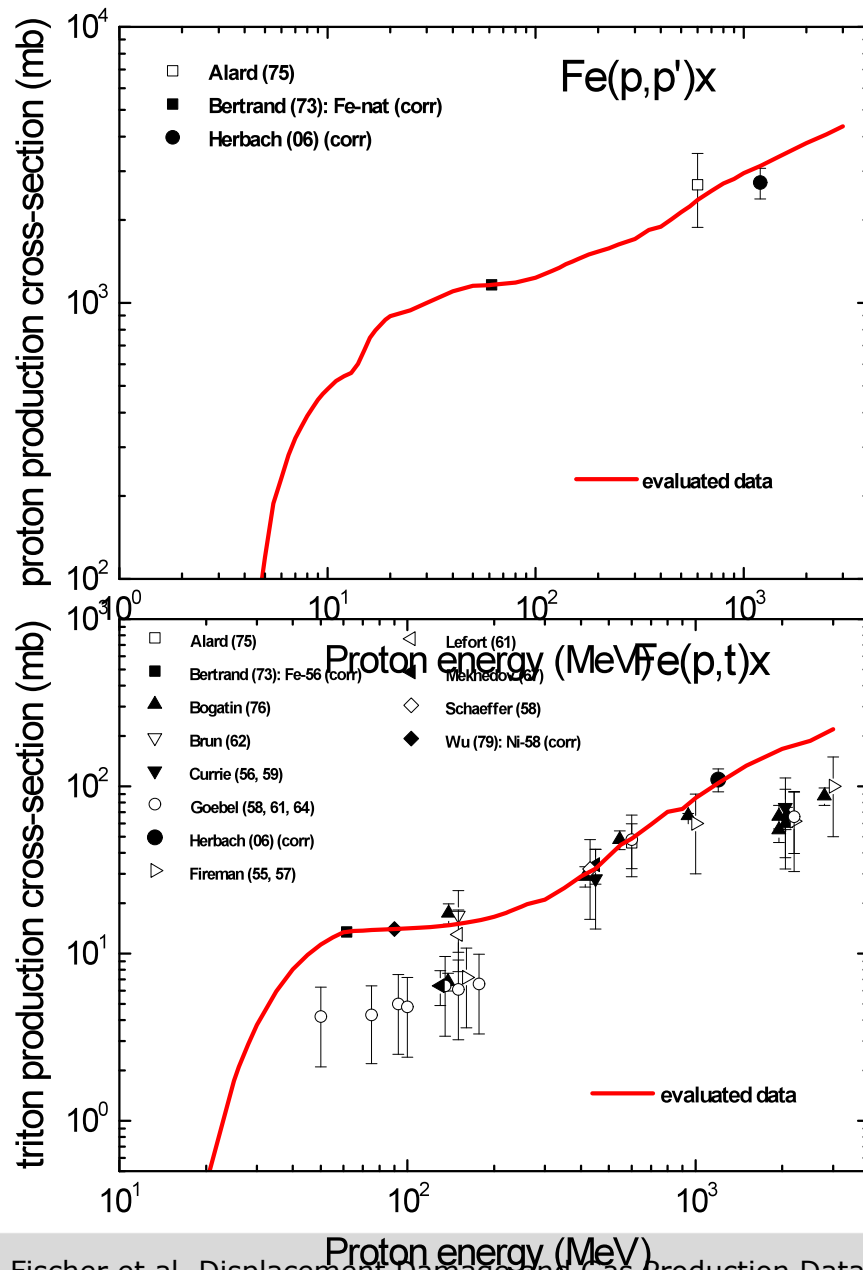

# KIT evaluated data – examples (cont'd)

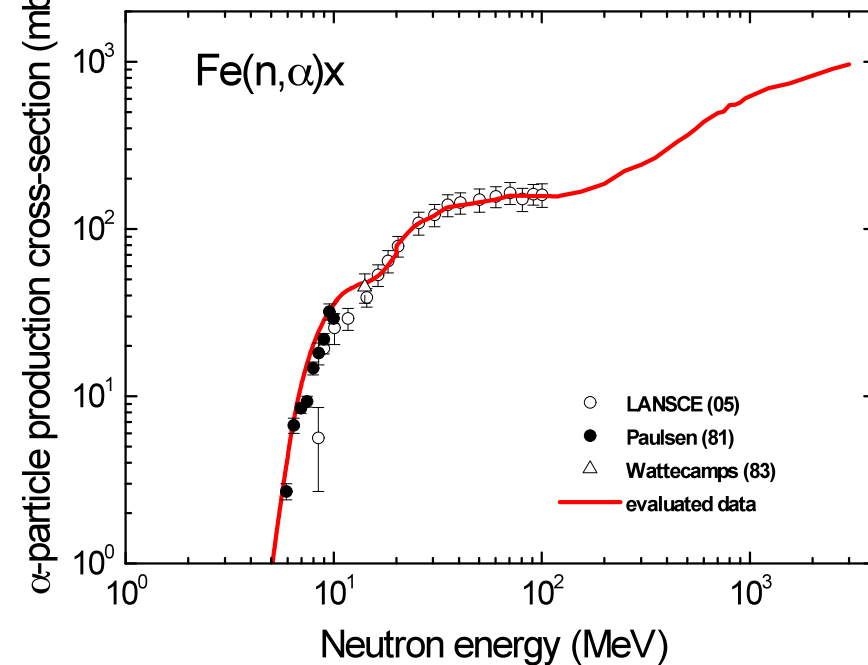
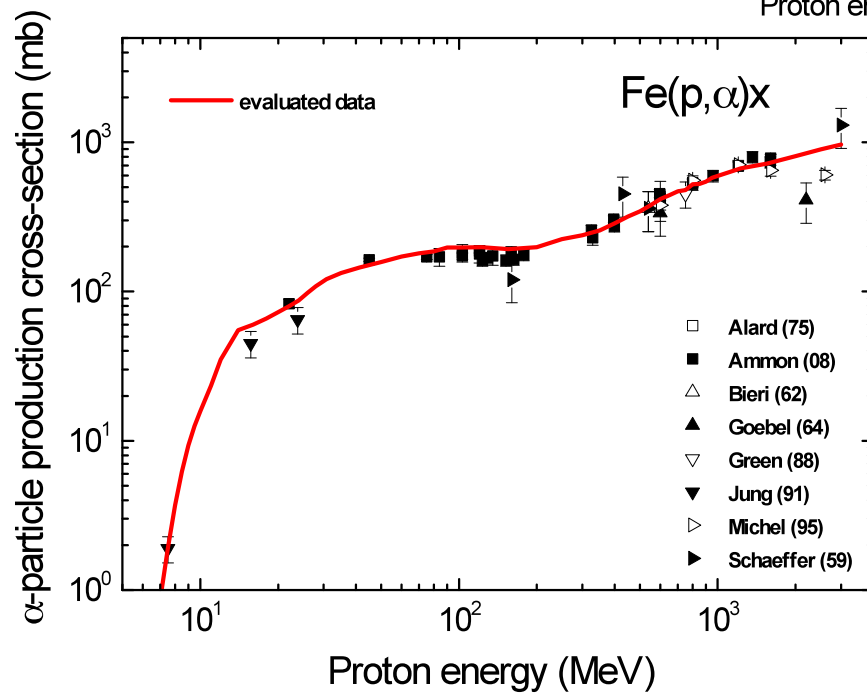
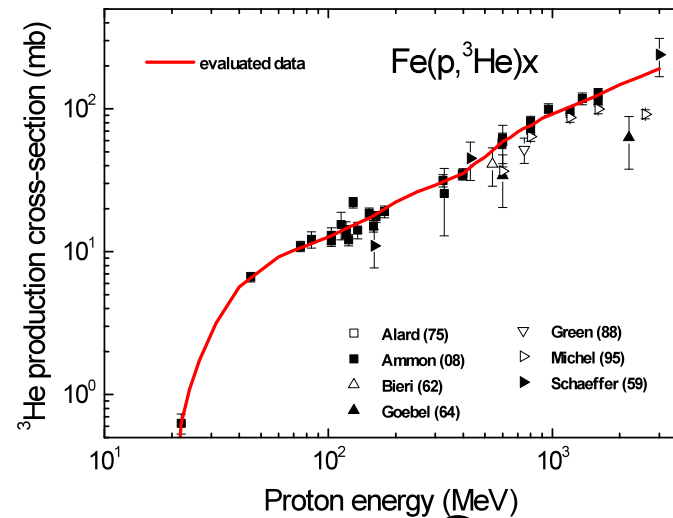

# KIT evaluated data files

- Neutron & proton data up to 3 GeV
- Fe, Cr, Ni + Al, Zr, Cu, W
- Data files in standard ENDF-6 format
- Gas production cross-sections for p-, d-, t-,  $^3\text{He}$ ,  $^4\text{He}$  (MT=203-207)
- Displacement cross-sections for BCA-MD (MT=900) and NRT (MT=901)
- Data files can be processed into ACE format for direct use with MCNPX(\*)

---

(\*) *p data require patch or secondary input*

# Windowless Liquid Metal Target Design for ESS

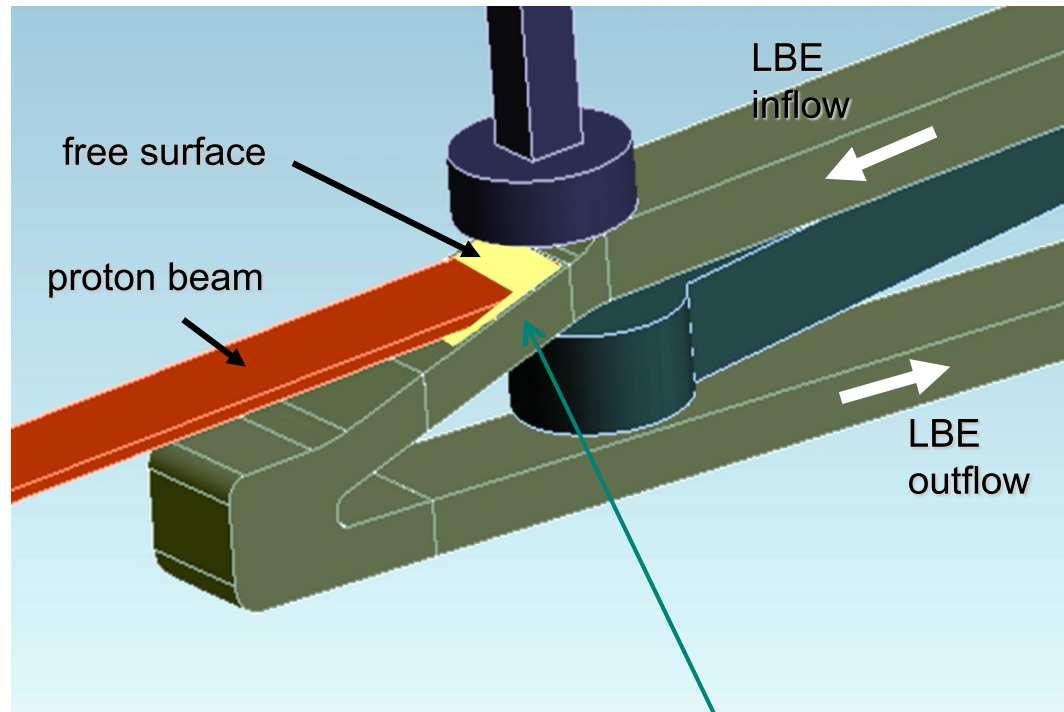

SS-316 structure walls

See A. Class et al, Windowless liquid metal target concept for ESS, this workshop

- Proton beams impinges liquid metal at  $15^\circ$  inclination angle
- No direct interaction of proton beam and solid structures
- Radiation damage to structure walls due to neutron irradiation

# Neutronics calculations

- MCNPX, Version 2.7a, using CEM cascade model
- Source: Proton beam  $E_p=2500$  MeV with Gaussian profile incident at  $15^\circ$  on PbBi free surface target
- Geometry model: PbBi enclosed in SS-316 steel frame
- Calculations of n-, p-flux, heating, dpa, gas production distributions using mesh tallies
- Use of evaluated dpa & gas production cross-section data for dpa and gas production rates in SS-316
- Typically 10 million source particle histories tracked with fractional standard deviation (FSD) around 1 %.

MCNPX target model

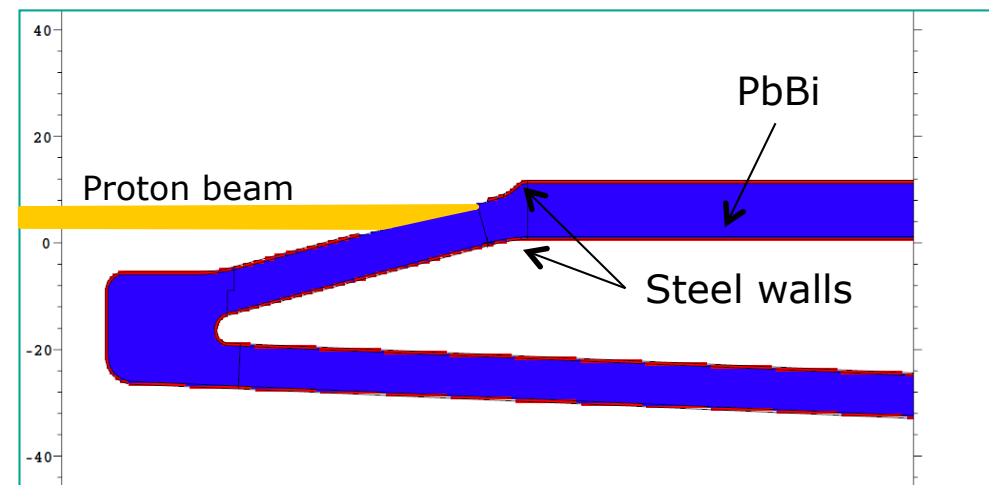



# Neutronics results for target side wall (SS-316)

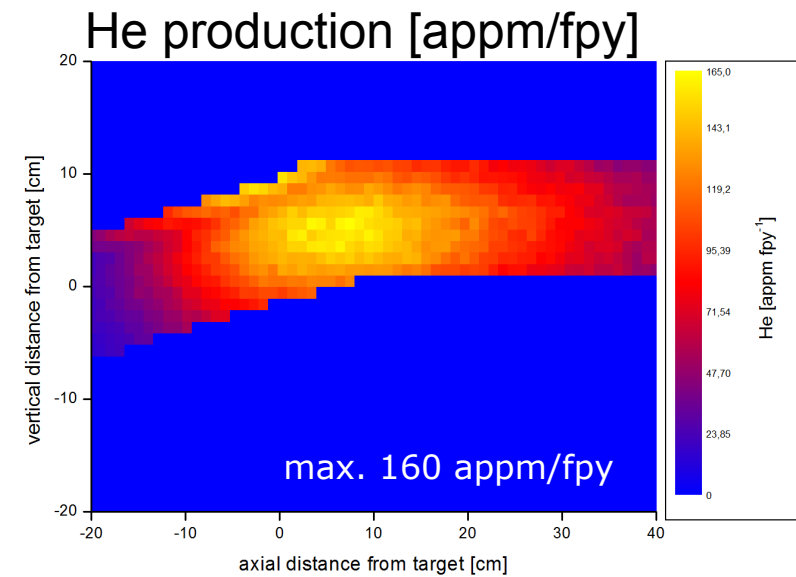
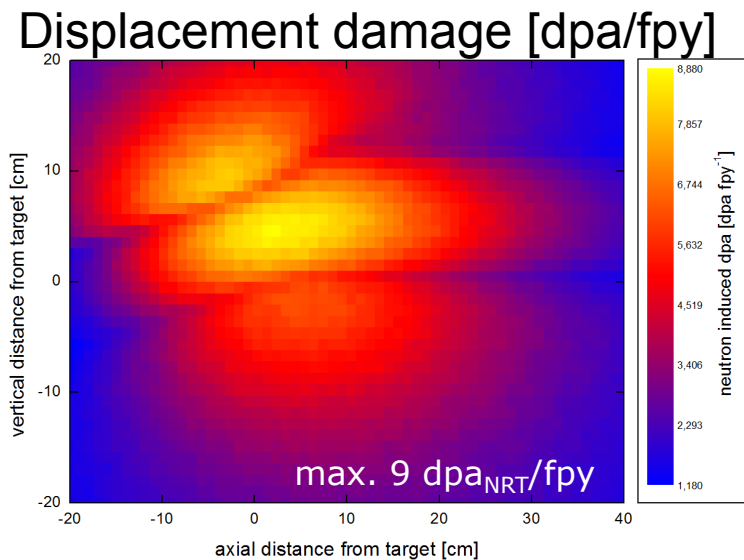
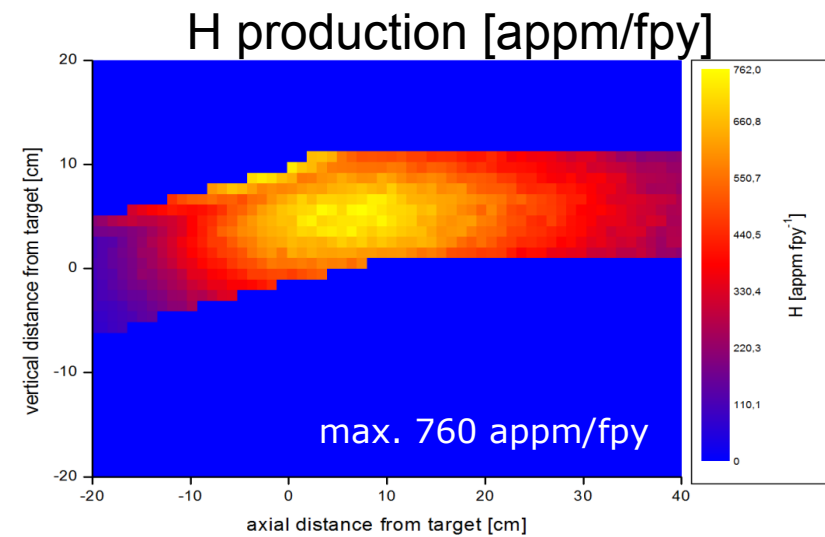
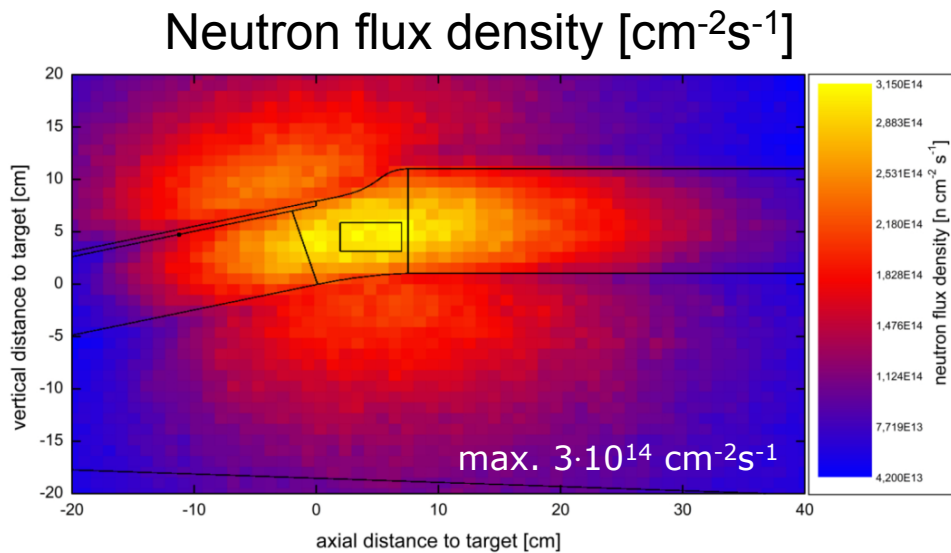

# Neutronics results for bottom wall (SS-316)

## Neutron flux density [ $\text{cm}^{-2}\text{s}^{-1}$ ]

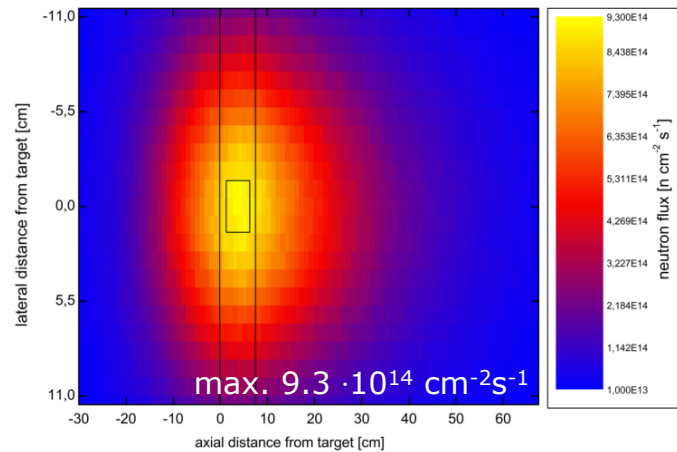

## H production [appm/fpy]

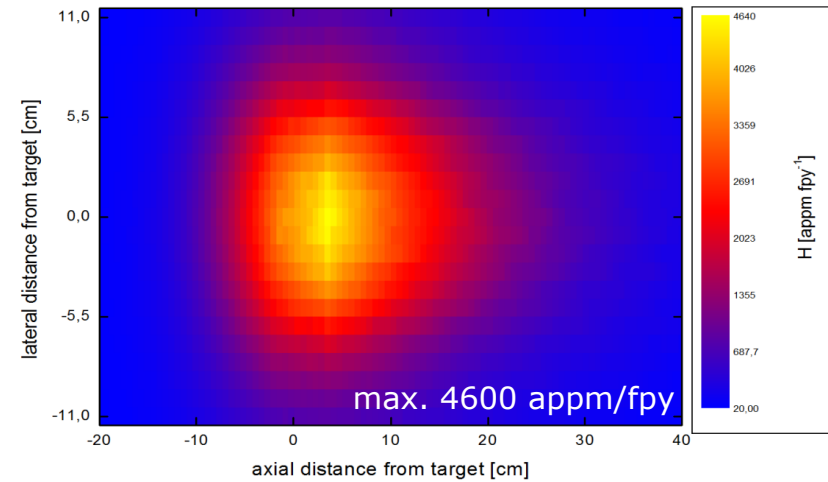

## Displacement damage [dpa/fpy]

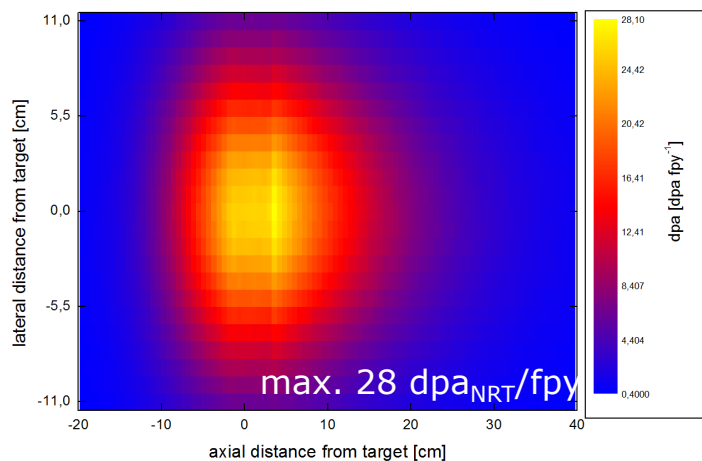

## He production [appm/fpy]

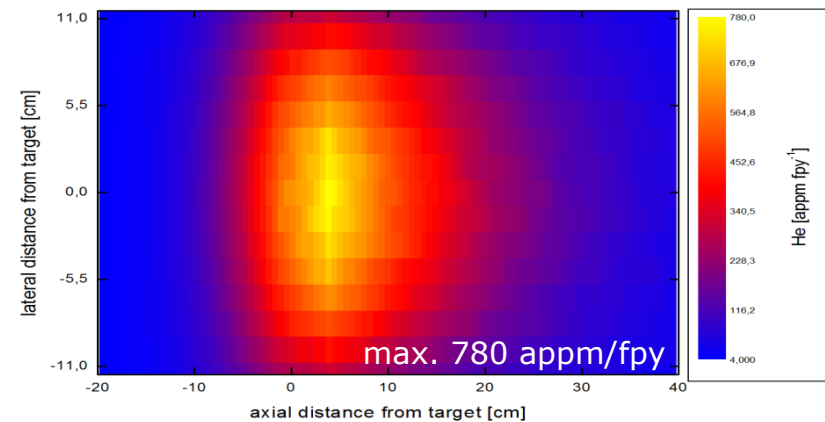

# Neutronics results for upper wall (SS-316)

## Neutron flux density [ $\text{cm}^{-2}\text{s}^{-1}$ ]

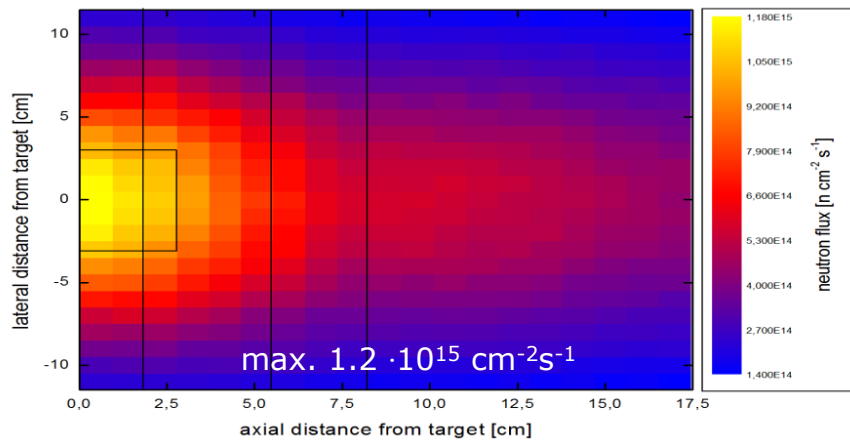

## H production [appm/fpy]

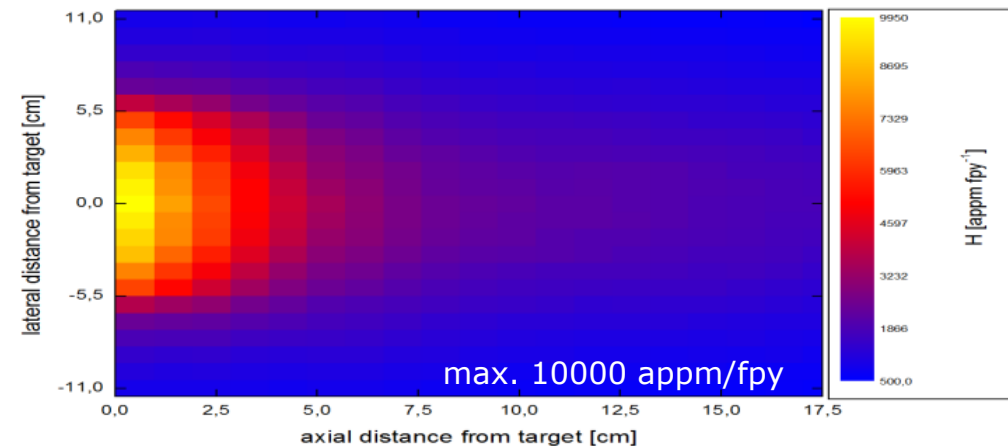

## Displacement damage [dpa/fpy]

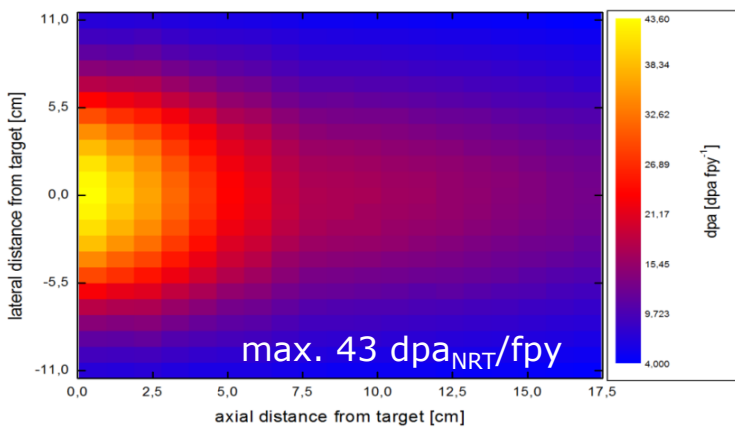

## He production [appm/fpy]

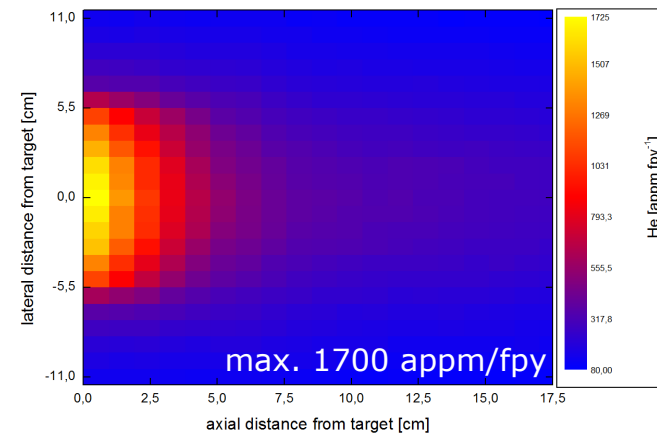

## Conclusions

- Evaluations performed for displacement and gas production data using advanced KIT approach
- Data for Fe, Cr, Ni (+Al, Zr, Cu, W), n - and p induced reactions up to 3 GeV
- ENDF data files available upon request
- Application analyses for ESS windowless liquid metal target
- Data can be used with MCNP/MCNPX  
... and other codes