

Powder jet targets for Neutrino Facilities

Ottone Caretta, Tristan Davenne, **Chris Densham**
(Rutherford Appleton Laboratory),

Richard Woods (Gericke Ltd),

Tom Davies (Exeter University), Goran Skoro (Sheffield
University), John Back (Warwick University)



Motivations: what are the limits of solid target technology? E.g. T2K Graphite target for 750 kW operation

Phase I

750 kW, 30-40
GeV beam

Power deposited in
target \approx 25 kW

Helium cooled
graphite rod

Phase II

3-4 MW

Target options?

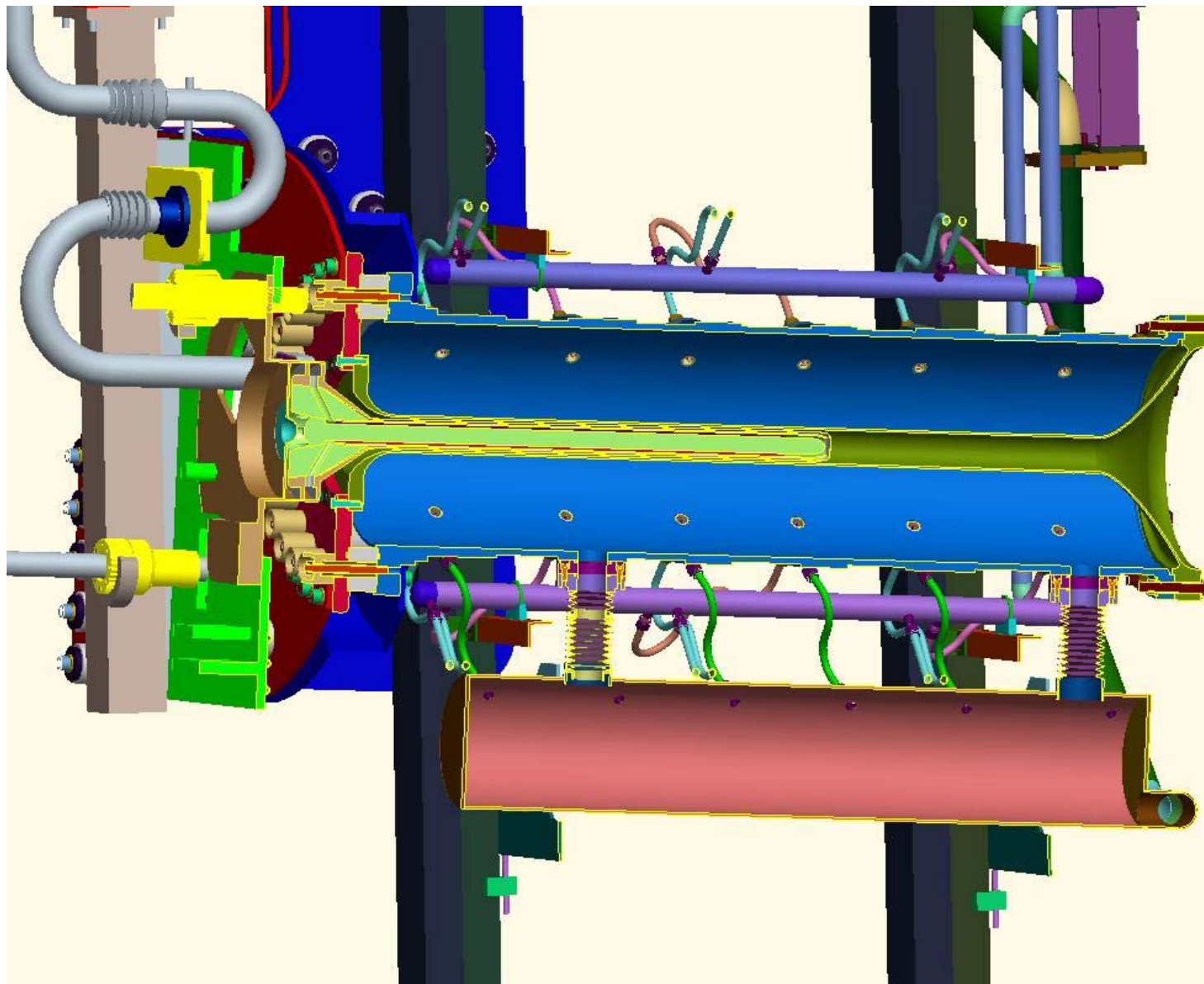

T2K graphite target design and installation within the 1st magnetic horn for T2K Phase 1 (750 kW beam, 30 kW deposited in target)

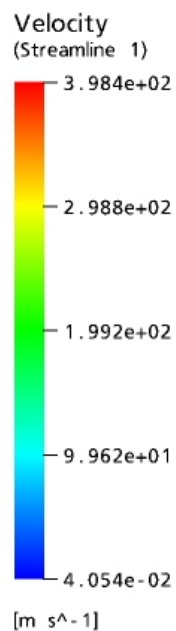
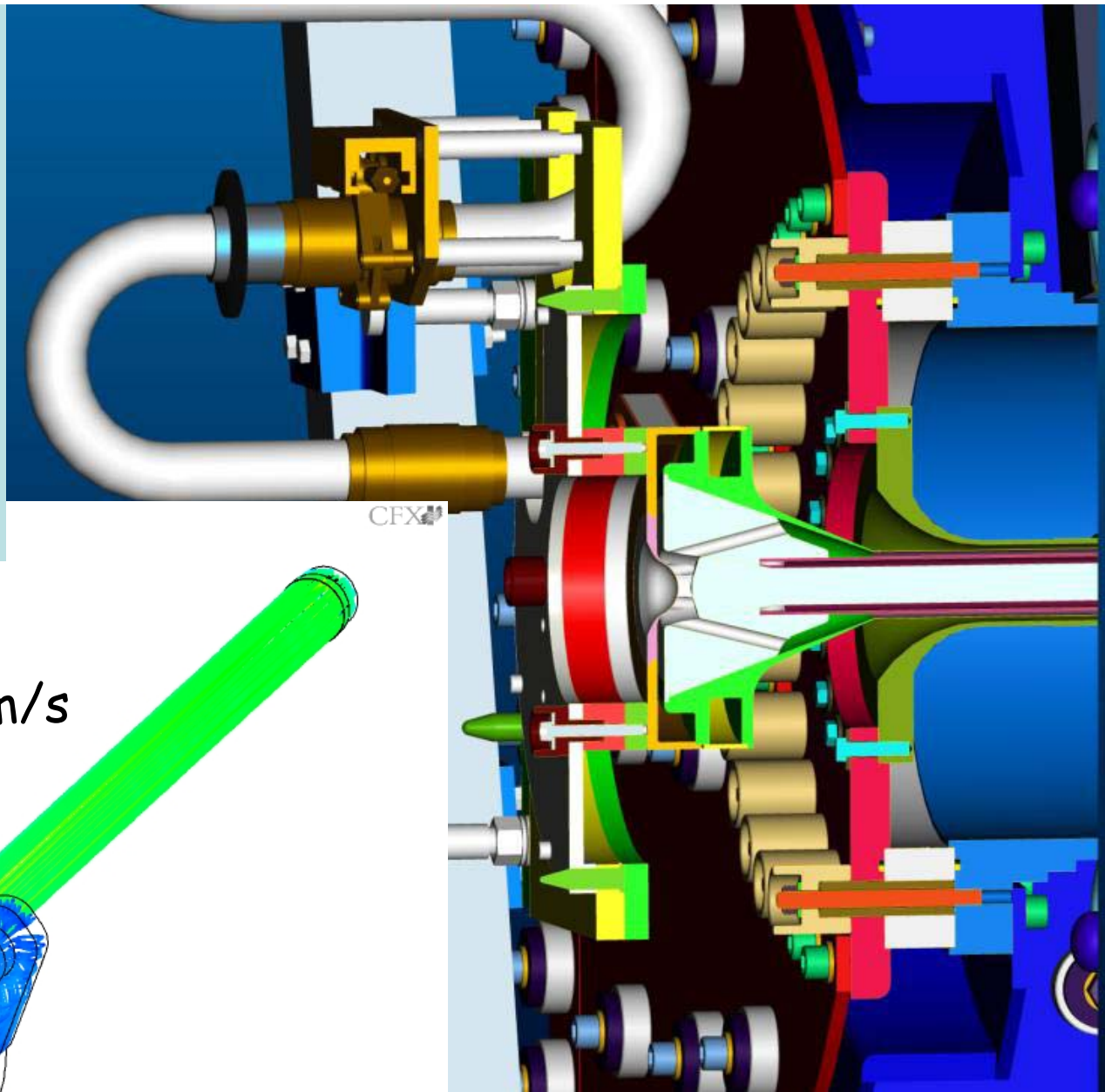

Max. helium velocity c.400 m/s

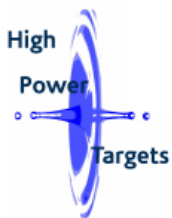
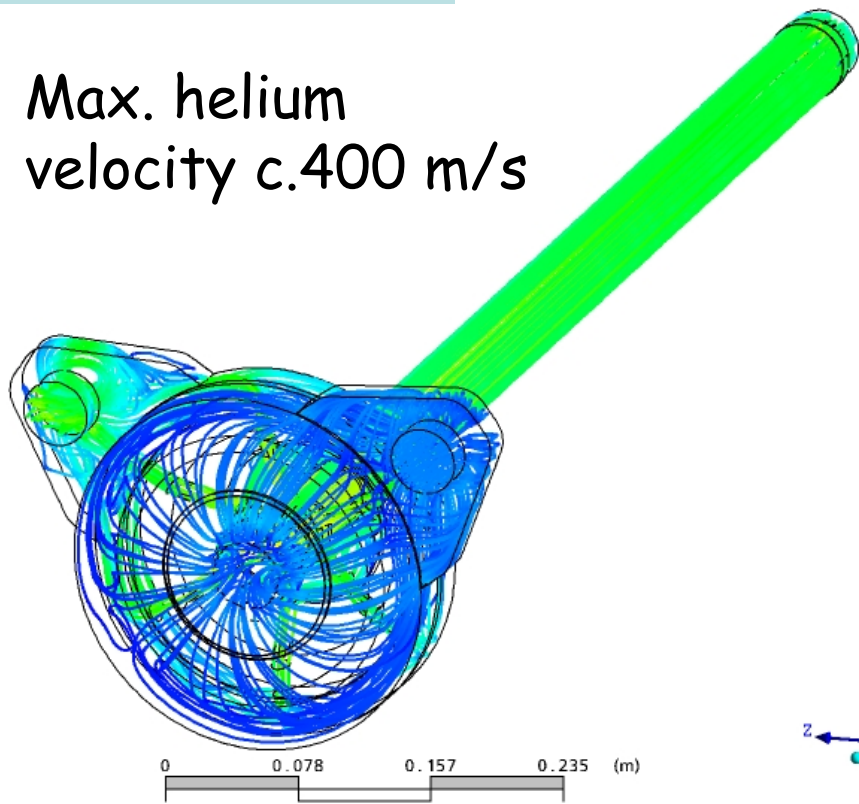

Chris Densham
Oxford 1-2 May 2008



Science & Technology Facilities Council
Rutherford Appleton Laboratory

Target technology problems:

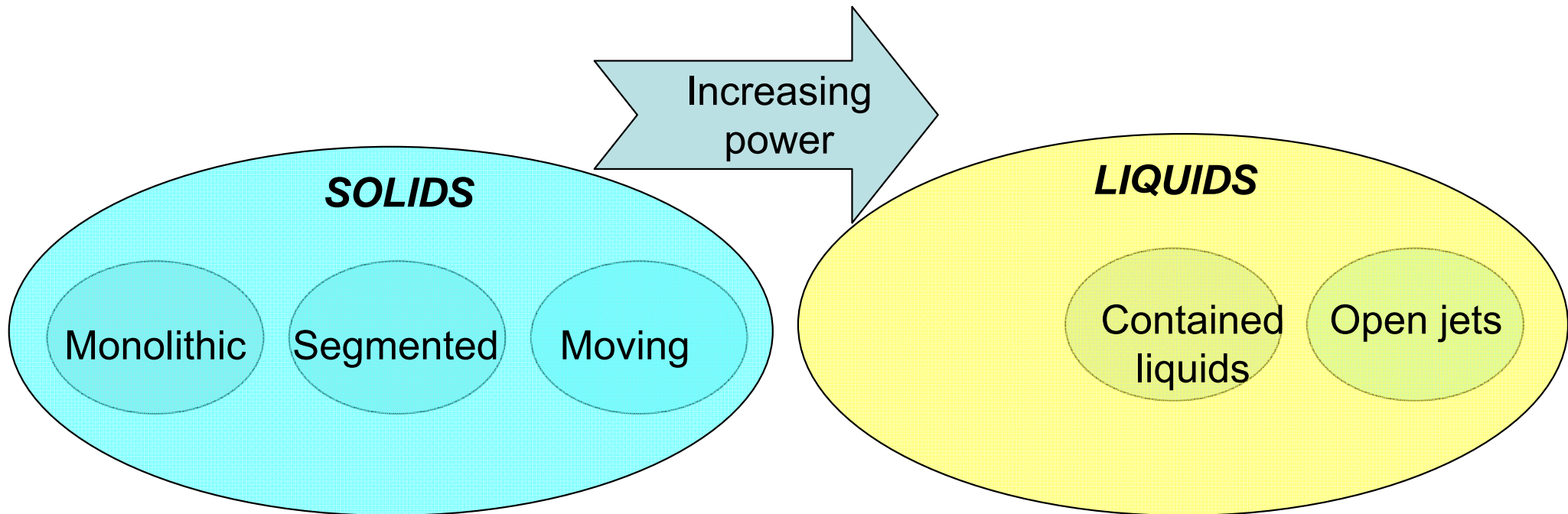

Challenges:

Power
dissipation
Radiation
damage
Shock waves/
thermal stress

Cooling
Lubrication
/ tribology
Reliability

Shock waves,
Cavitation
Corrosion
Radiochemistry

Splashing,
radiochemistry,
corrosion

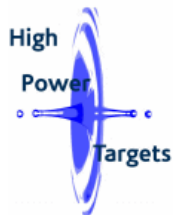

Options for T2K upgrade to Superbeam

- Beam window: should be OK if increased power is gained by increasing rep rate.
- Target: Static target difficult beyond 1 MW beam power - problems include:
 - Power dissipation
 - Thermal stress
 - Radiation damage
 - High helium flow rate, large pressure drops or high temperatures
- Target: expect to replace target increasingly often as beam power increases
- New target technology seems necessary

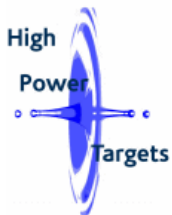

Mercury jet targets

Baseline for Neutrino
Factory and Muon Collider:
(NuFact Study IIa)

CERN SPL study for a
Superbeam

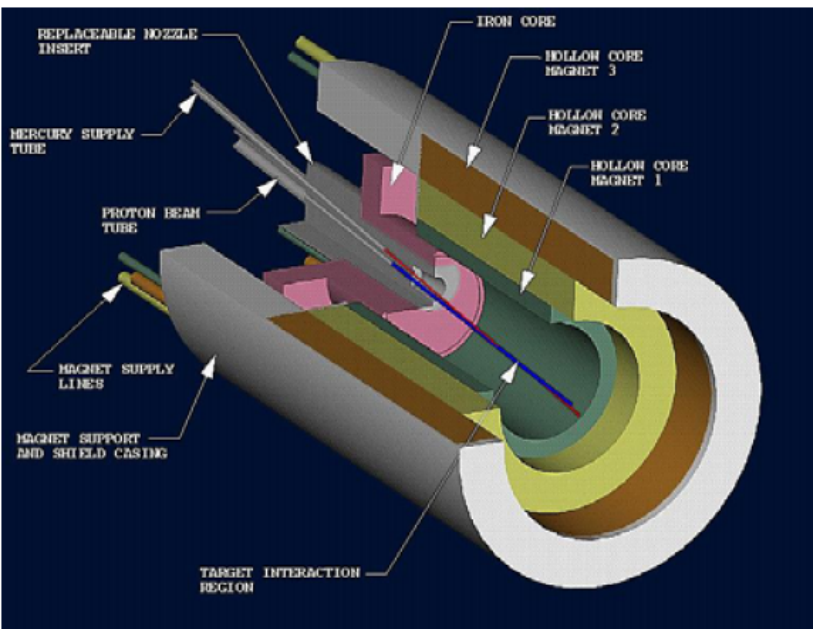

2.2 GeV
at 4MW
50 Hz
operation

Protons →

Hg Jet

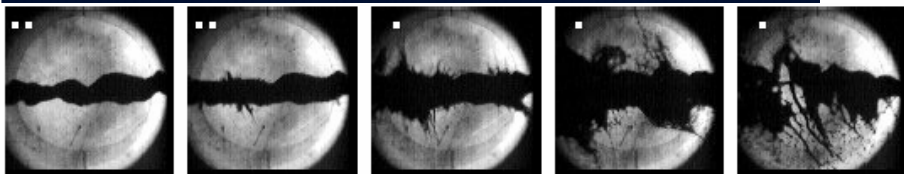
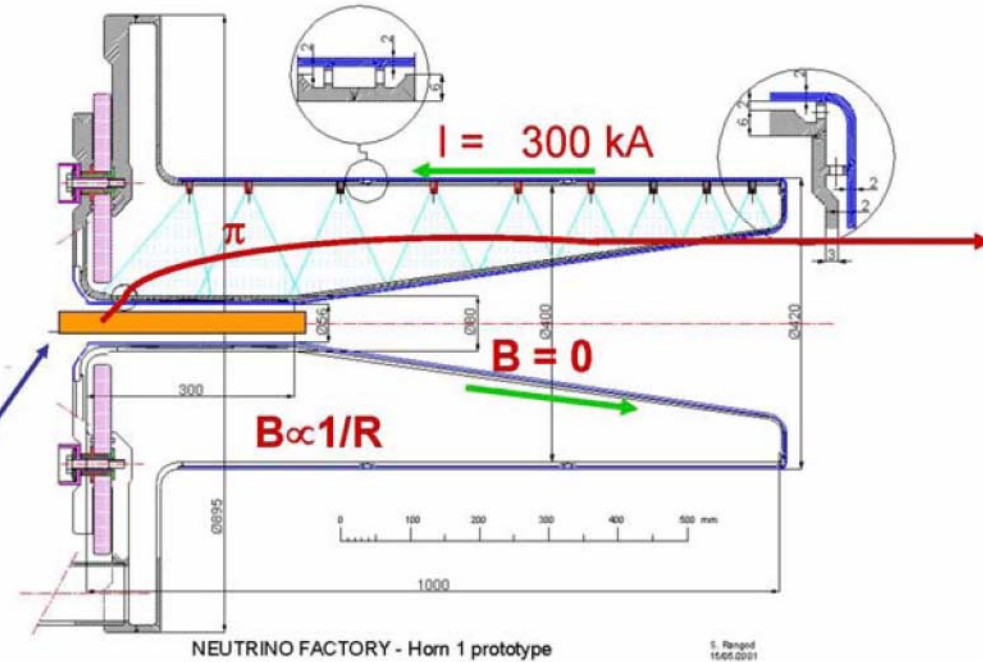

MERIT experiment underway today!

BUT: Difficult to combine
mercury jet with magnetic
horn (Hg → Al corrosion)

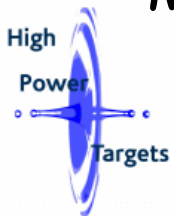

Chris Densham
Oxford 1-2 May 2008

HPT

SuperBeam: Other Target Ideas

P. Sievers proposed a packed 2mm granular tantalum bed as a NuFact/SuperBeam target, cooled by flowing helium

BUT: difficult to remove heat at 4 MW operation

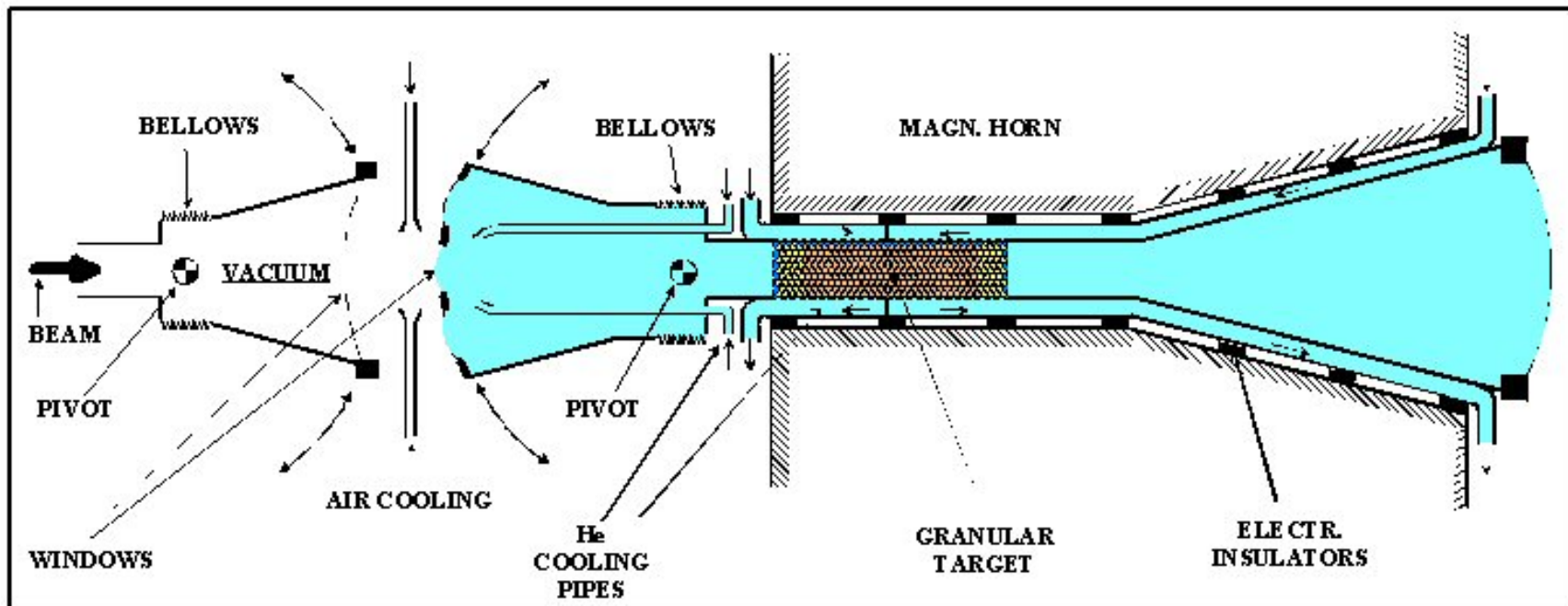

Is there a 'missing link' target technology?

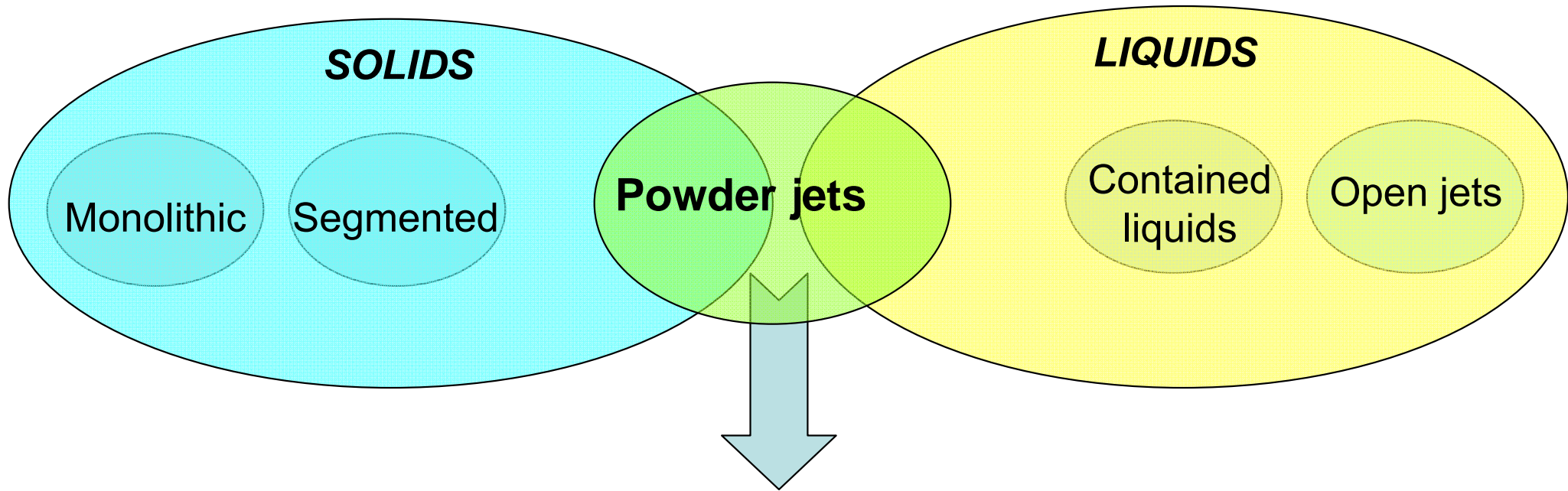

Examples: fluidised jets of particles in a carrier gas

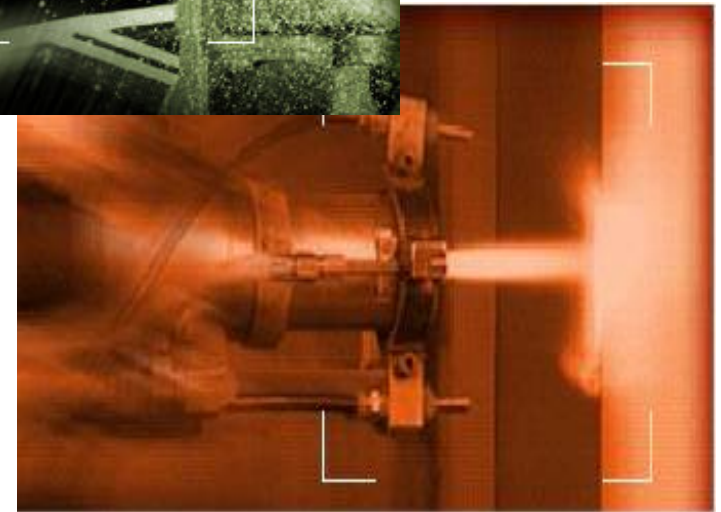
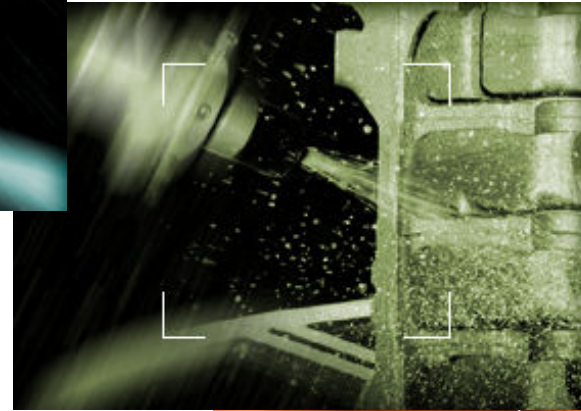
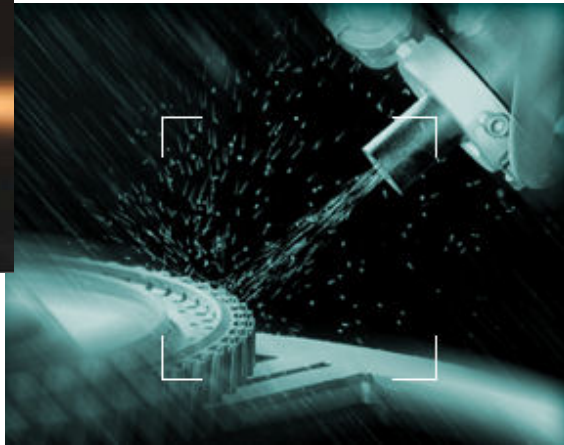
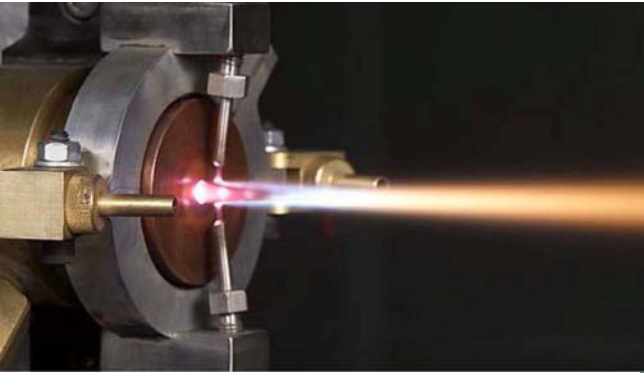

Chris Densham
Oxford 1-2 May 2008

HPT



Science & Technology Facilities Council
Rutherford Appleton Laboratory

Different fluidising technologies

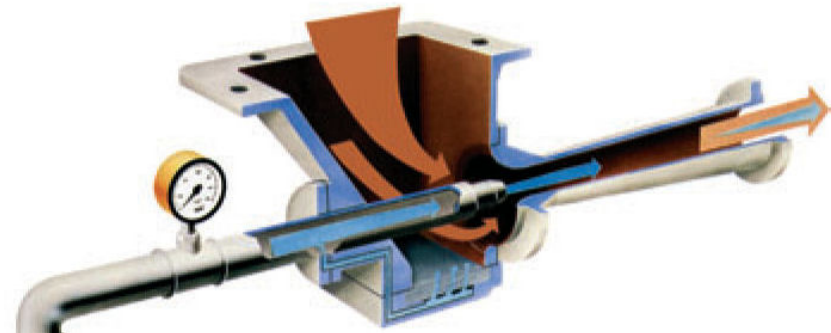
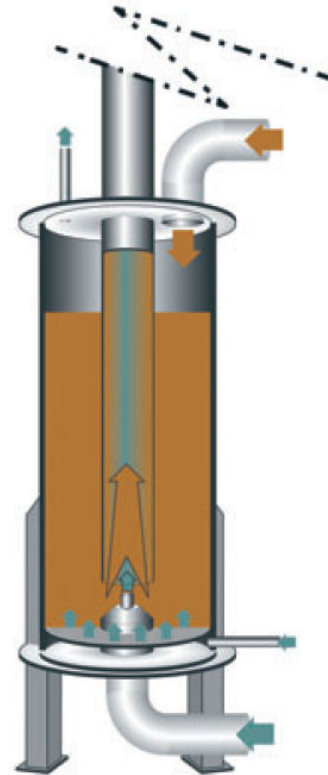
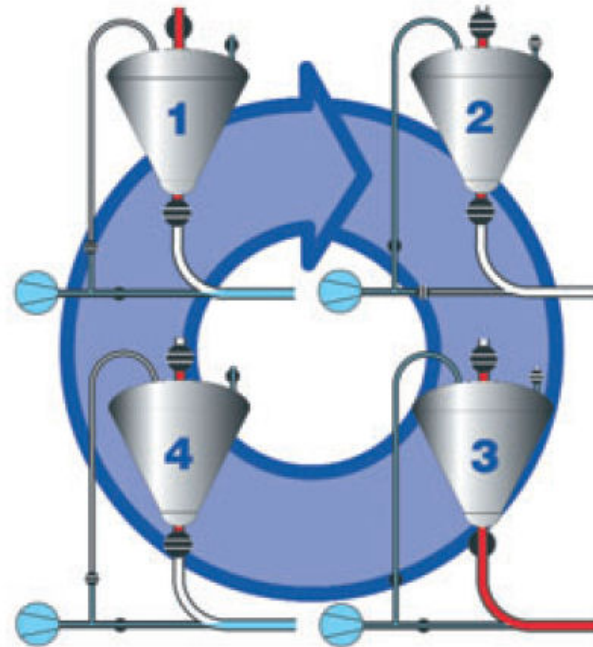
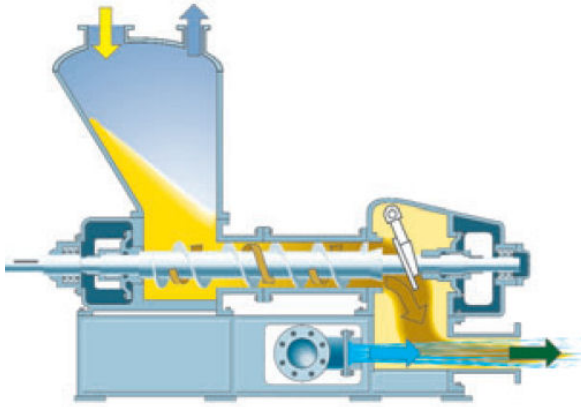

www.claudiuspeters.com



Chris Densham
Oxford 1-2 May 2008

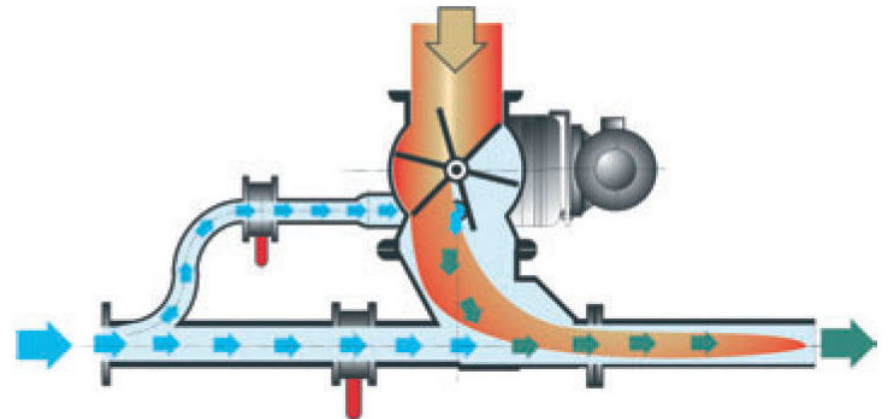

HPT



Science & Technology Facilities Council
Rutherford Appleton Laboratory

Powder jet targets: some potential advantages

- **Shock waves**
 - a near hydrostatic stress field develops in particles so high power densities can be absorbed without material damage
 - Shock waves constrained within material and not transmitted through material, e.g. sand bags used to absorb impact of bullets
 - no splashing or jets as for liquids
 - Material is already broken - intrinsically damage proof
- **Heat transfer**
 - A flowing powder provides high heat transfer opportunities so the bed can dissipate high energy densities and total power (and perhaps multiple beam pulses)
 - External cooling favoured - as for liquid metal targets
- **Solid vs liquid?**
 - Carries some of the advantages of both the solid phase and of the liquid phase:
 - metamorphic, can be shaped to suit
 - Pumpable
 - Replenishable



Elastic stress waves and thermal expansion

Smaller particles have higher resonance frequencies and dissipate their energy faster than larger particles

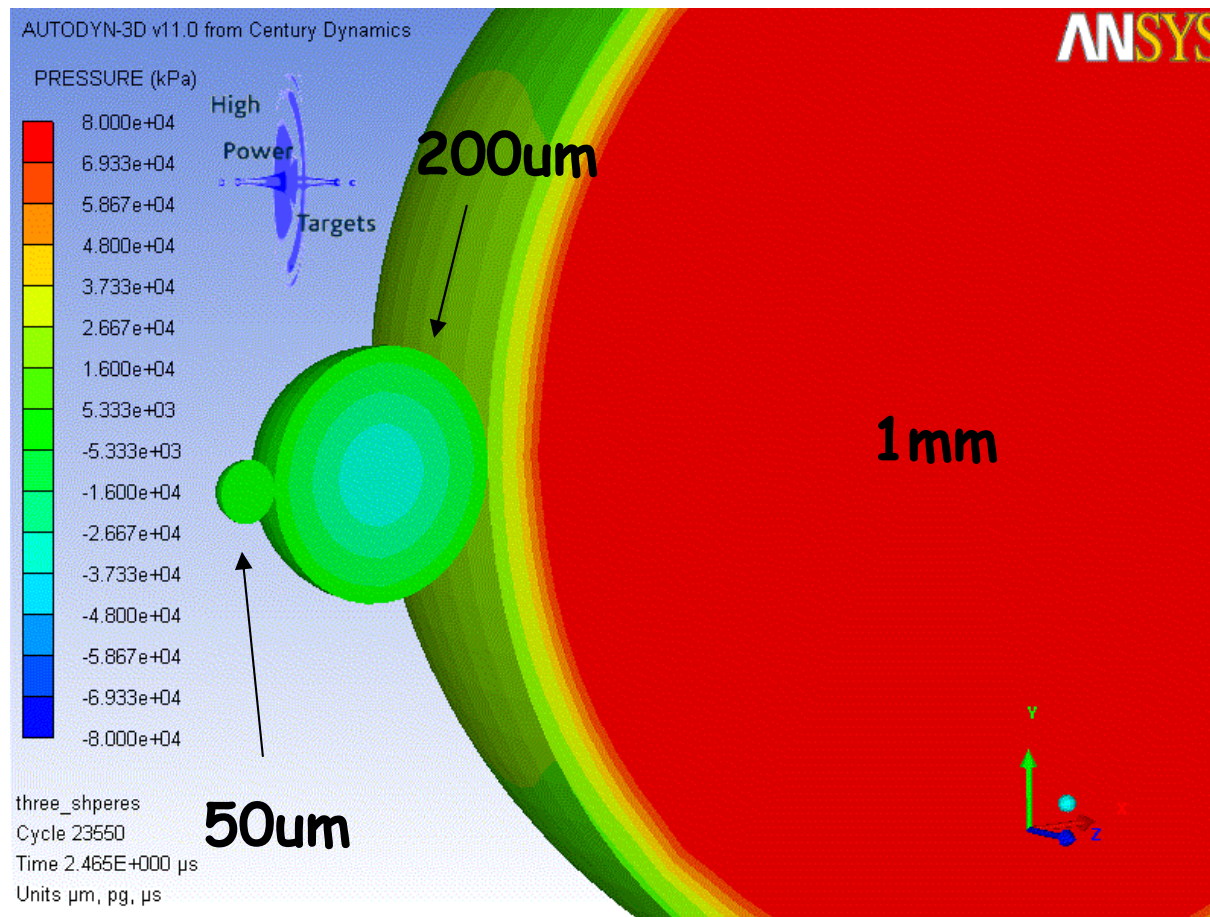

Autodyne simulation
by O. Caretta

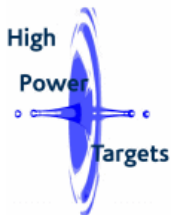

Chris Densham
Oxford 1-2 May 2008

HPT

Powder jet targets: some potential difficulties

- Erosion of material surfaces, e.g. nozzles
- Activated dust on circuit walls (no worse than e.g. liquid mercury?)
- Activation of carrier gas circuit
- Achieving high material density - typically 50% material packing fraction for a powdered material



Some solutions to erosion problems

Turbulent energy dissipation

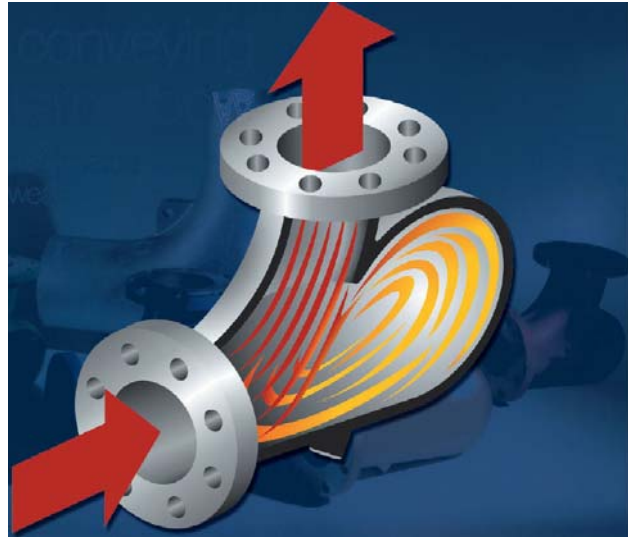

Ceramic pipe linings



Specially designed gravity fed heat exchangers

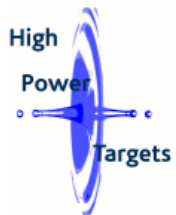
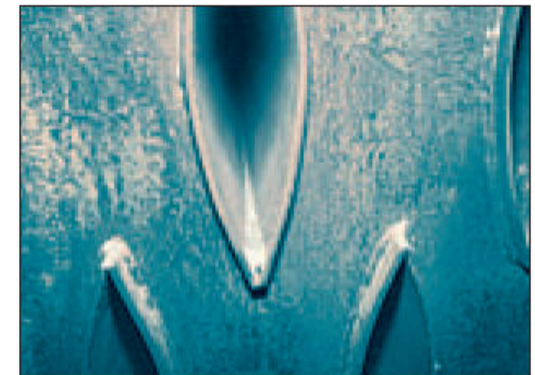
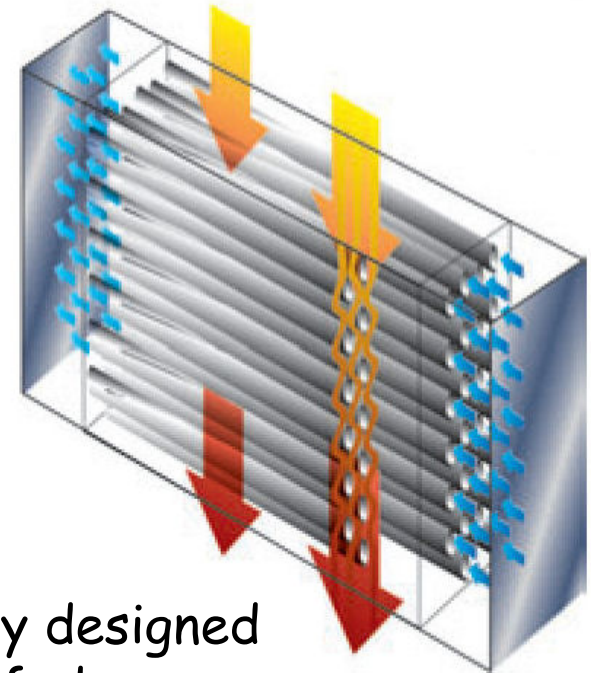

Chris Densham
Oxford 1-2 May 2008

HPT



Science & Technology Facilities Council
Rutherford Appleton Laboratory

Decommissioning: Disposal of spent powder

High-level radioactive waste from the nuclear industry is currently turned into powder before vitrification

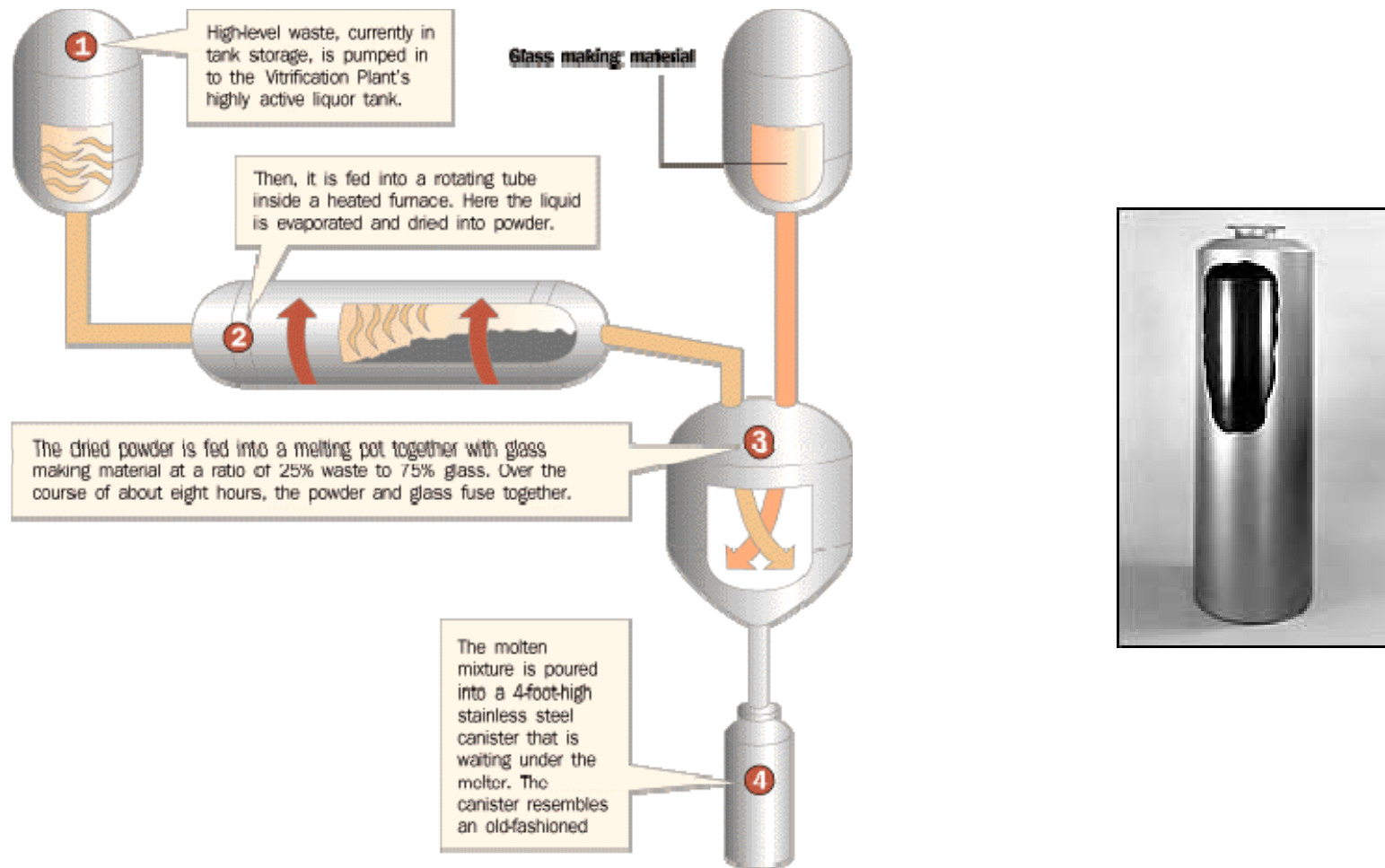

Could a flowing powder or powder jet be a useful target technology?

For a T2K upgrade or another Superbeam e.g. SPL

- Obvious material for T2K would be graphite powder
- But 50% material would reduce pion yield
- How about titanium powder?
- Density of titanium powder may be similar to solid graphite, ie $50\% \rho_{\text{Ti}} \approx \rho_{\text{graphite}}$

For a Neutrino Factory target

- Tungsten powder obvious candidate



A flowing powder target for a Superbeam or Neutrino Factory?

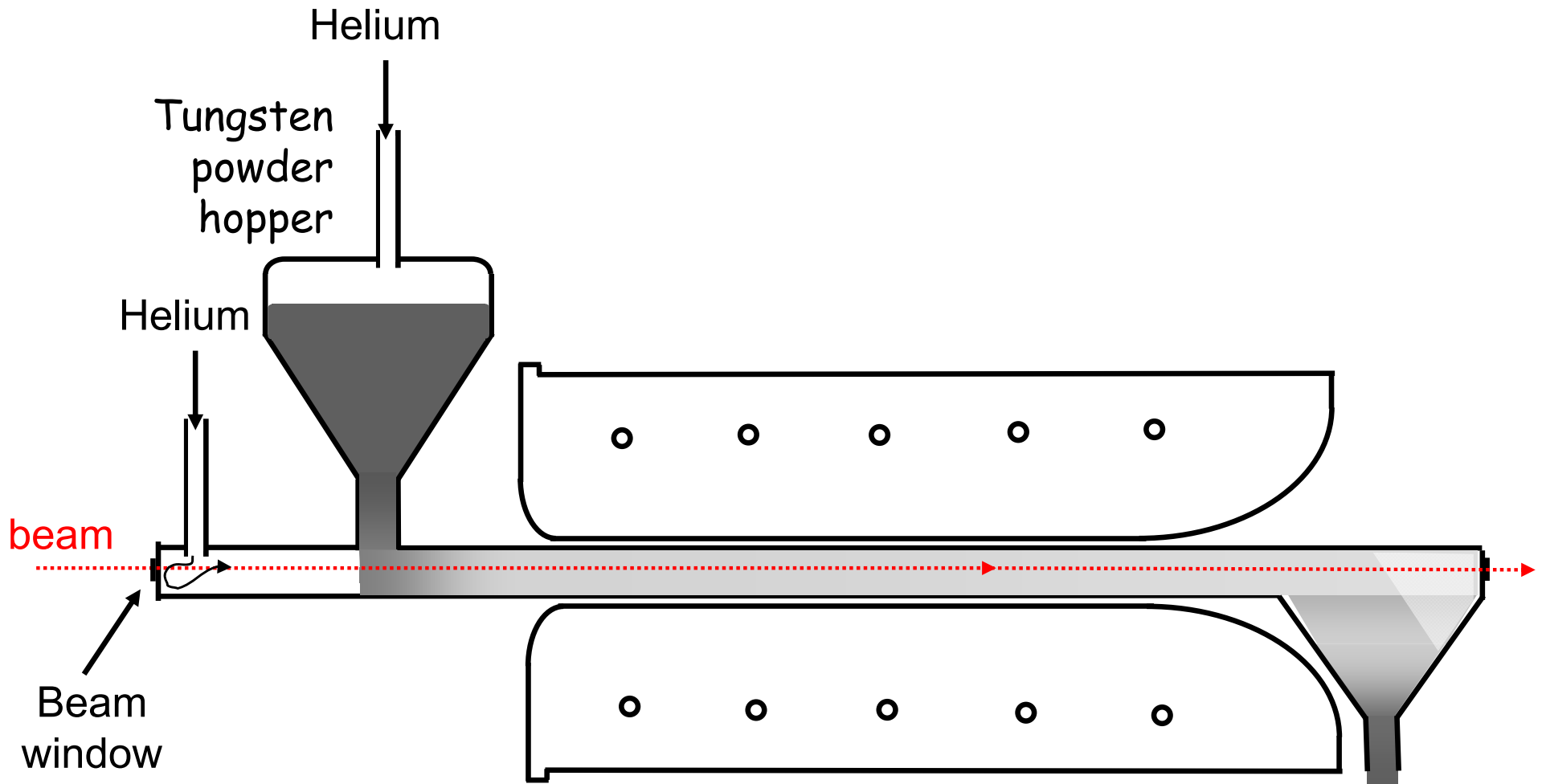

Neutrino Factory Study II

Target station layout

- W powder jet target roughly compatible with mercury jet target station layout - replace Hg pool with W powder receiver

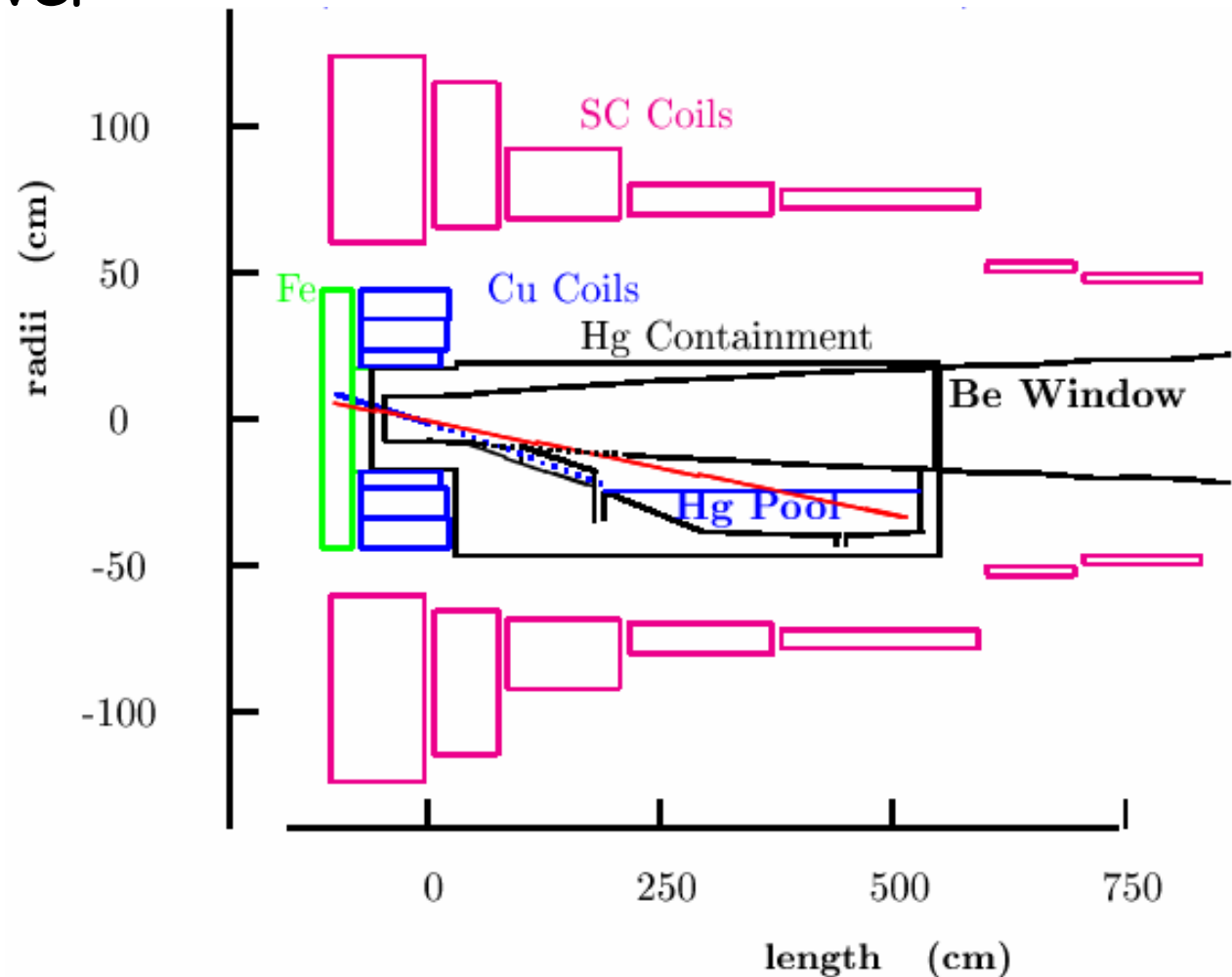

Neutrino Factory Study II

Target station layout

- W powder jet target roughly compatible with mercury jet target station layout - replace Hg pool with W powder receiver

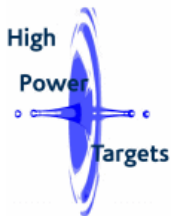
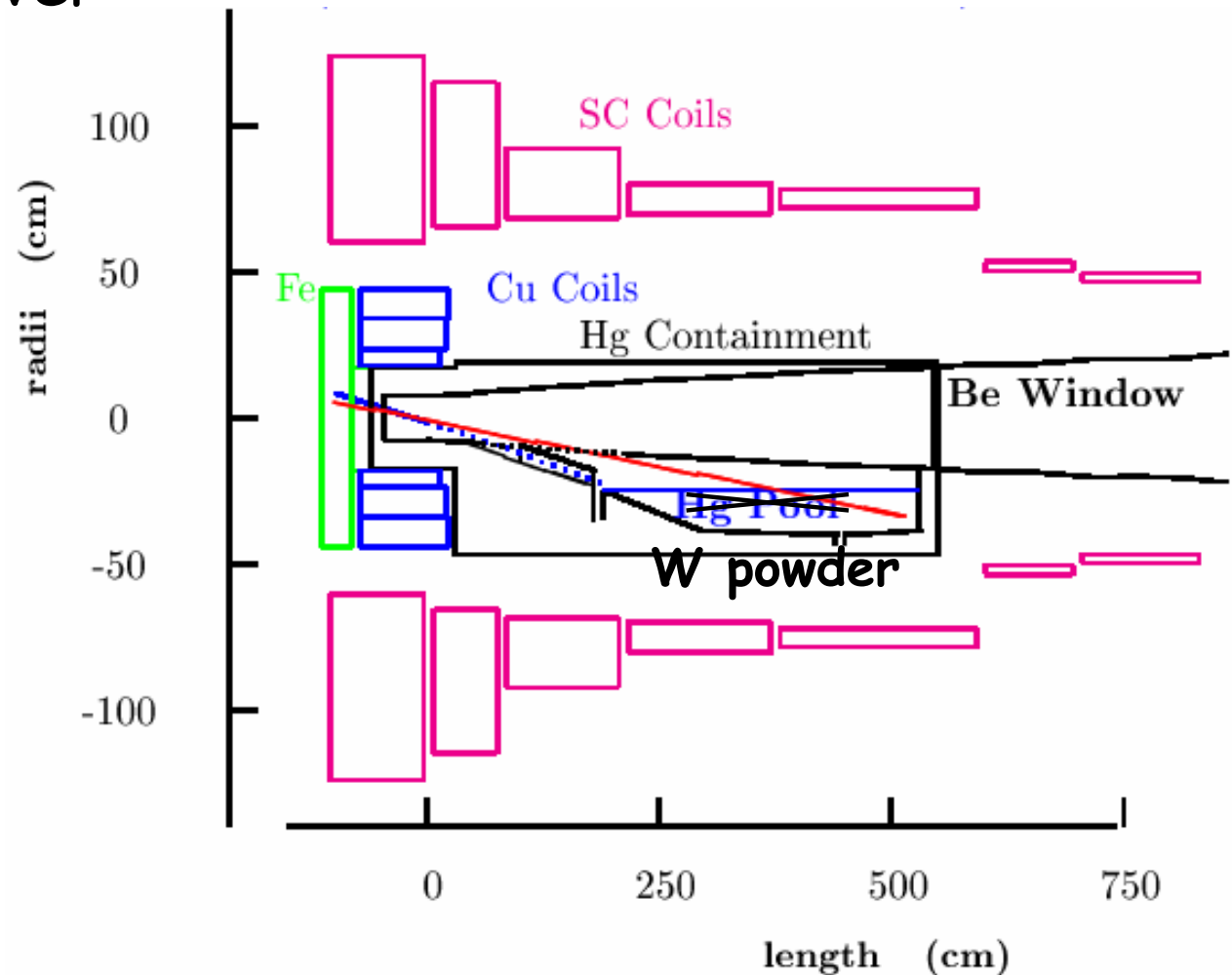

Pion yield for solid vs powdered tungsten

MARS calculation of muon and pion yield from

- (i) solid W and
- (ii) 50% density W

π and μ yield for one 30 cm W rod
($d = 2$ cm); $r_{\text{beam}} = 1$ cm

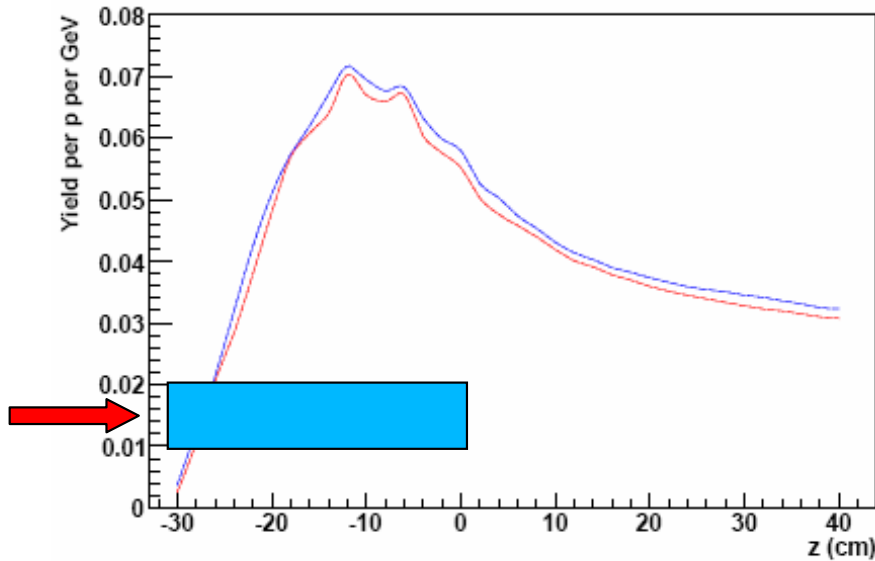

NB 1: Calculation is for 10 GeV protons

NB 2: Calculation is for total yield from target ie capture losses excluded

π and μ yield for one 60 cm W rod at 50% density ($d = 2$ cm); $r_{\text{beam}} = 1$ cm

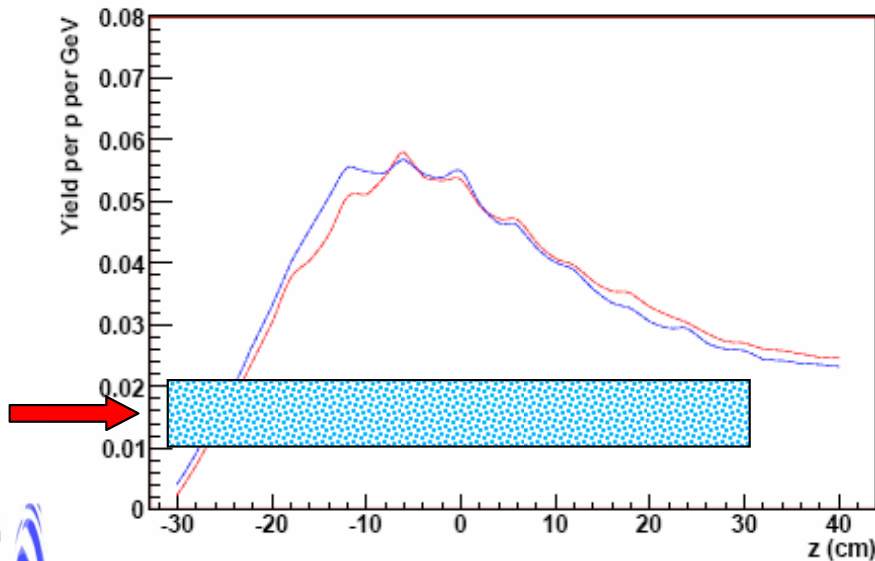

MARS simulation by J. Back

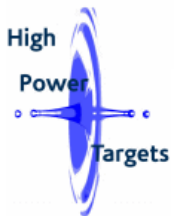

Chris Densham
Oxford 1-2 May 2008

HPT



Science & Technology Facilities Council
Rutherford Appleton Laboratory

Eddy currents in powder grains passing through solenoid

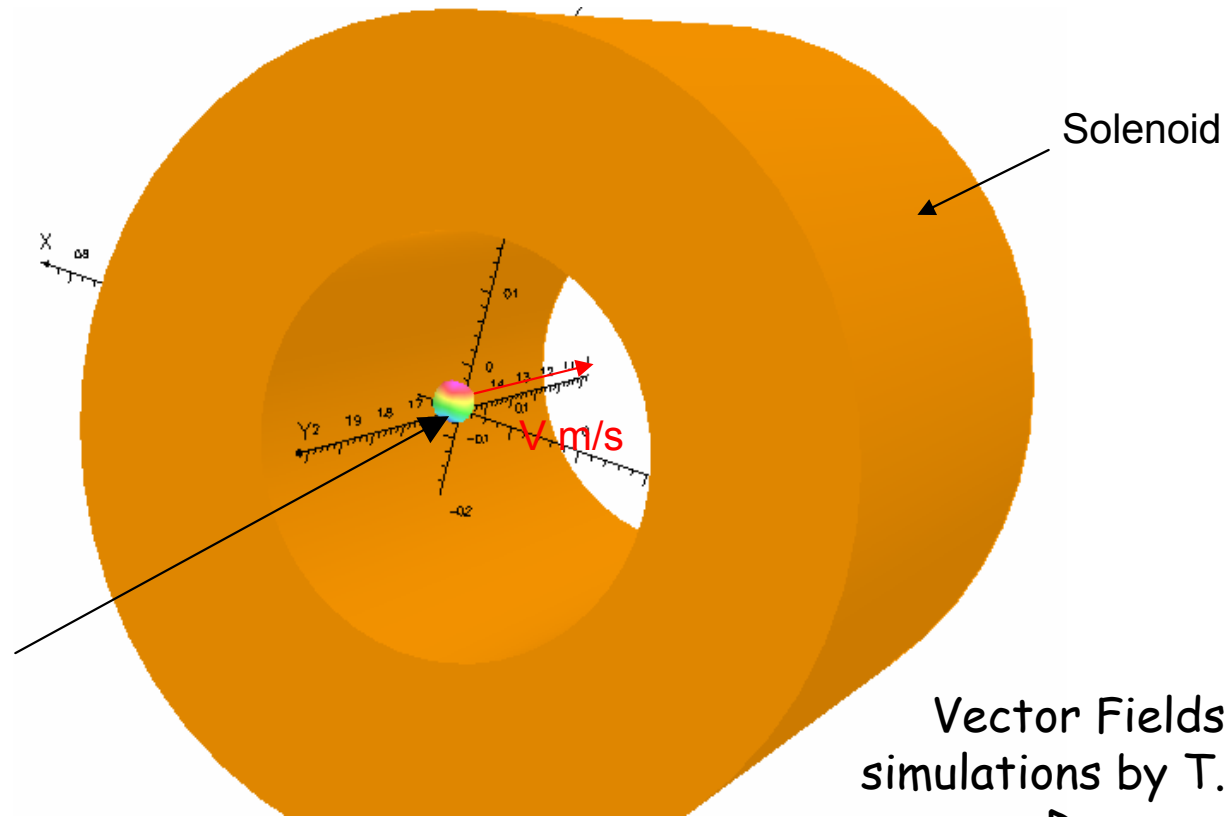
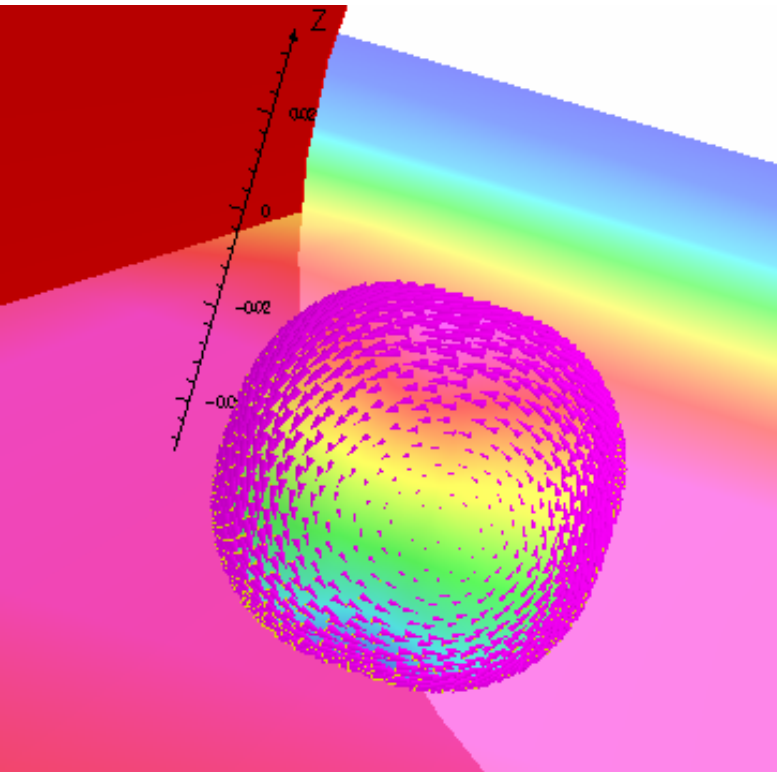

Vector Fields simulations by T. Davenne

<- Eddy current density in different size grains passing through 12.5 T solenoid at 20 m/s

-> Current loop area a grain area

$$a \approx 0.2\pi r^2$$

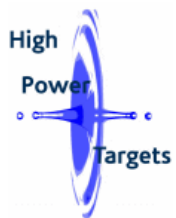
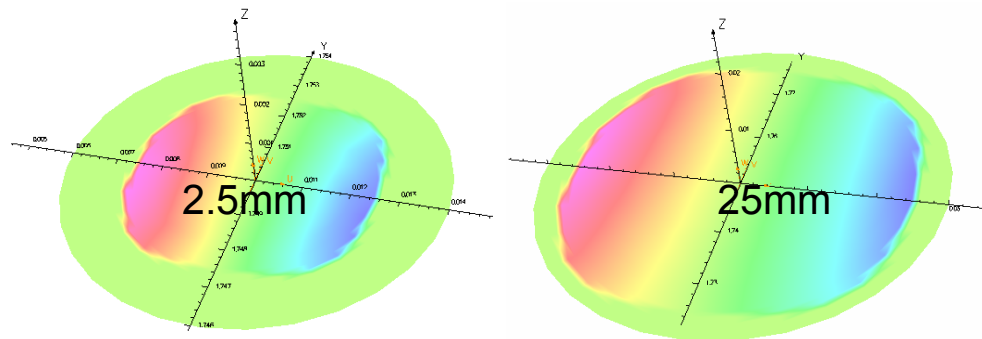

Axial force and deceleration as a function of particle radius

$$F_z = B_r IC$$

Assume $B_r = \frac{r dB_z/dz}{2}$

$$F_z = \frac{1}{2} (dB_z/dz)^2 \pi r^3 v a \sigma$$

$$= 0.1 (dB_z/dz)^2 v \sigma \pi^2 r^5$$

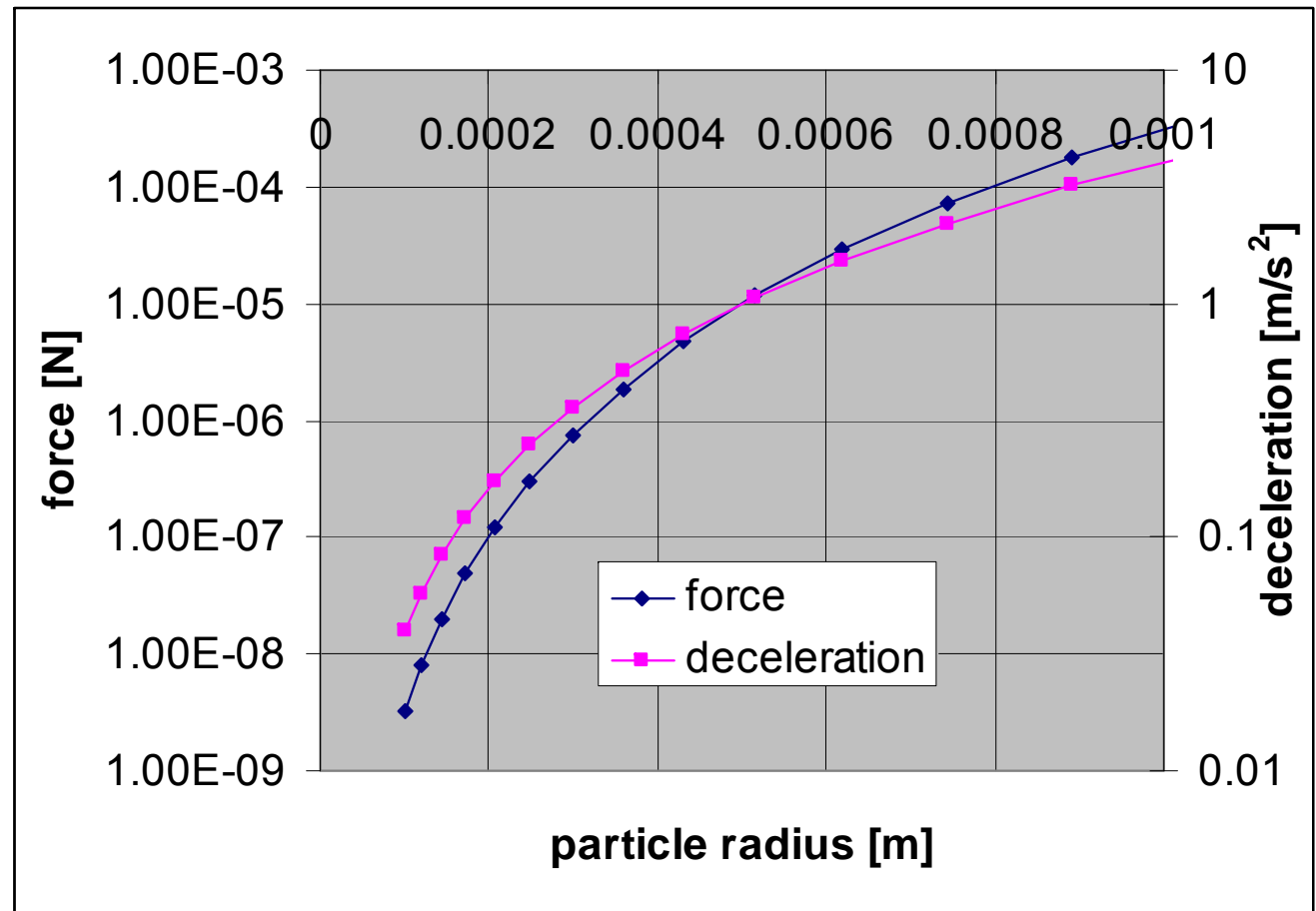

For a 250micron radius particle of tungsten entering the solenoid at 20m/s the peak axial deceleration is about 0.3m/s². If the particle decelerated at this rate throughout its passage through the solenoid (worst case assumption) then it would have slowed down by about 0.1%, i.e. reduction in speed is negligible.



Radial forces

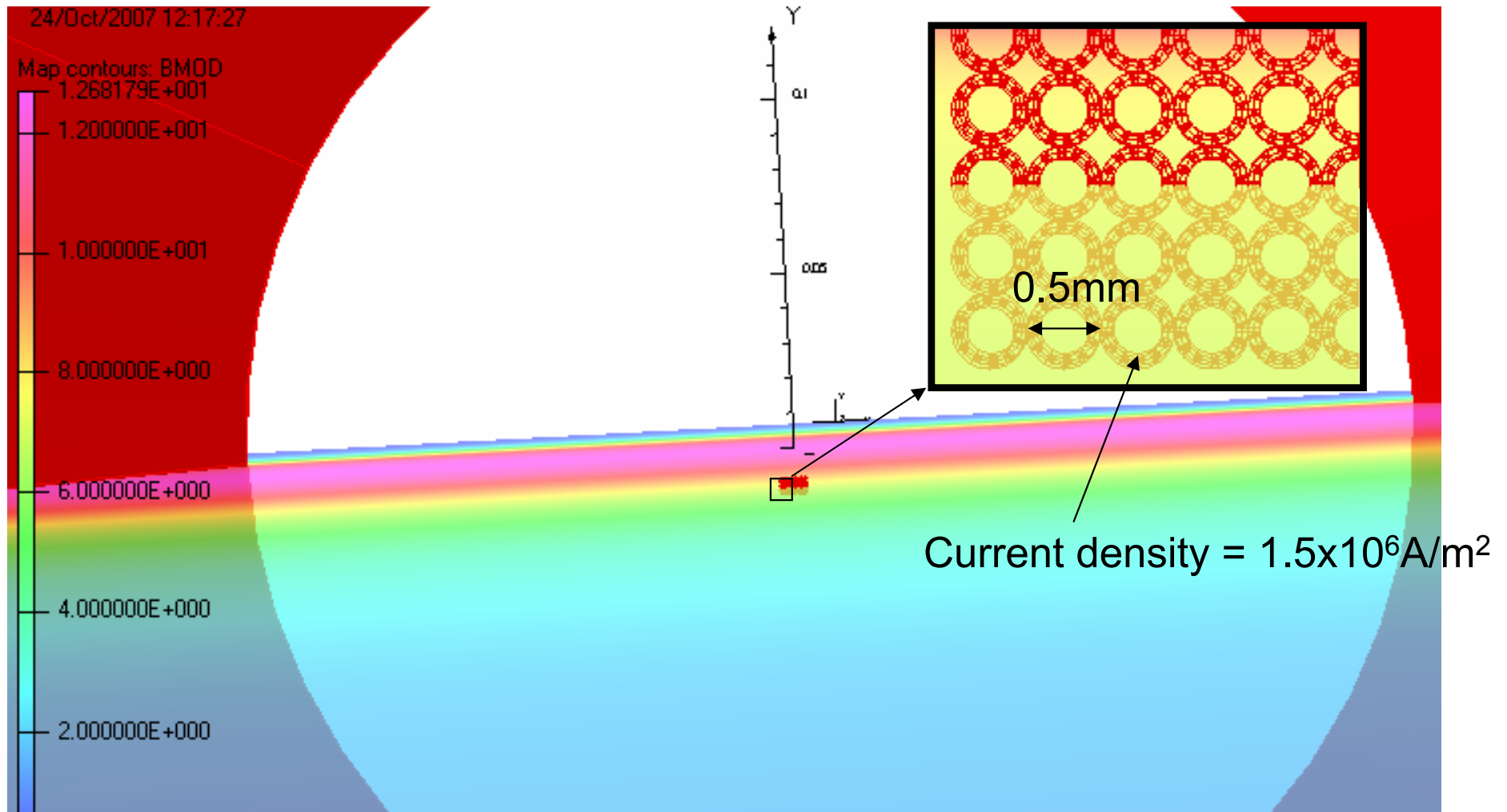

Model particles using Vector fields coil model. Idealised problem with each particle represented by a coil with its own current loop. The current density calculated from the expression for current derived earlier, i.e.

$$I = \frac{\pi r^2 dB_z / dz v a \sigma}{C}$$



Chris Densham
Oxford 1-2 May 2008

HPT



Science & Technology Facilities Council
Rutherford Appleton Laboratory

Stacking many coils together to simulate a particle jet
- each coil has radius of 0.25mm

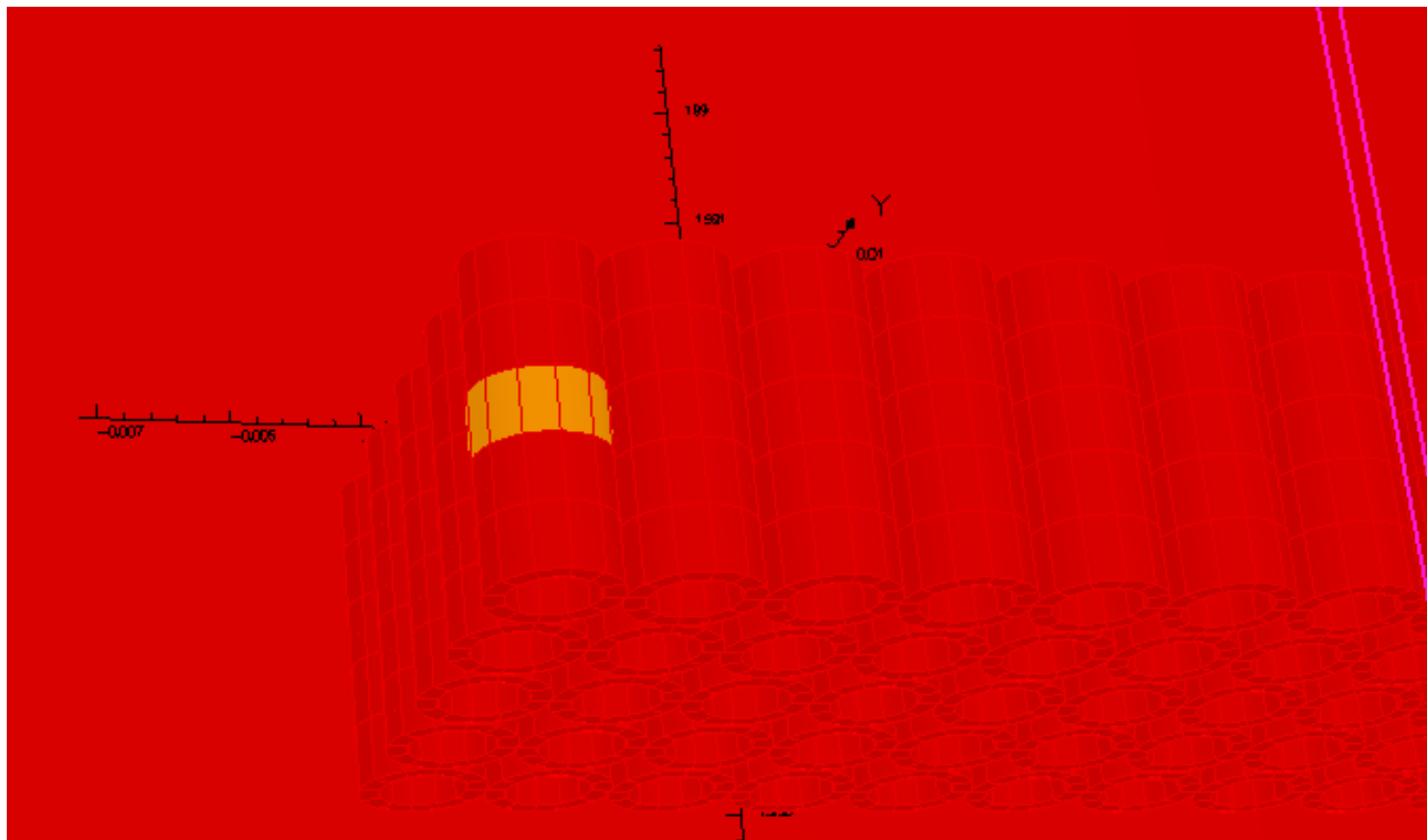

Each coil assumed to have current density of $1.5 \times 10^6 \text{ A/m}^2$ (NB this value is dependant on dB_z/dz which seems to be unaffected by the presence of the stack of coils)

Coils in a stack experience decentralising forces (pushing them away from the central axis of the solenoid) due to repulsions from their neighbours.

Maximum decentralising force occurs on coils at the extremity of the stack like the one highlighted in the picture. As a particle jet passes through a solenoid one could imagine the outer layer of particles being stripped off and as this happens the decentralising force on the next layer of particles would increase and then that layer will be stripped off. **What is the magnitude of the repulsive force?**

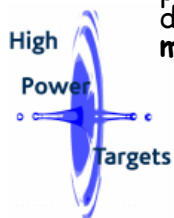

Magnitude of repulsive force calculated from Vectorfields coil model on 8 adjacent coils

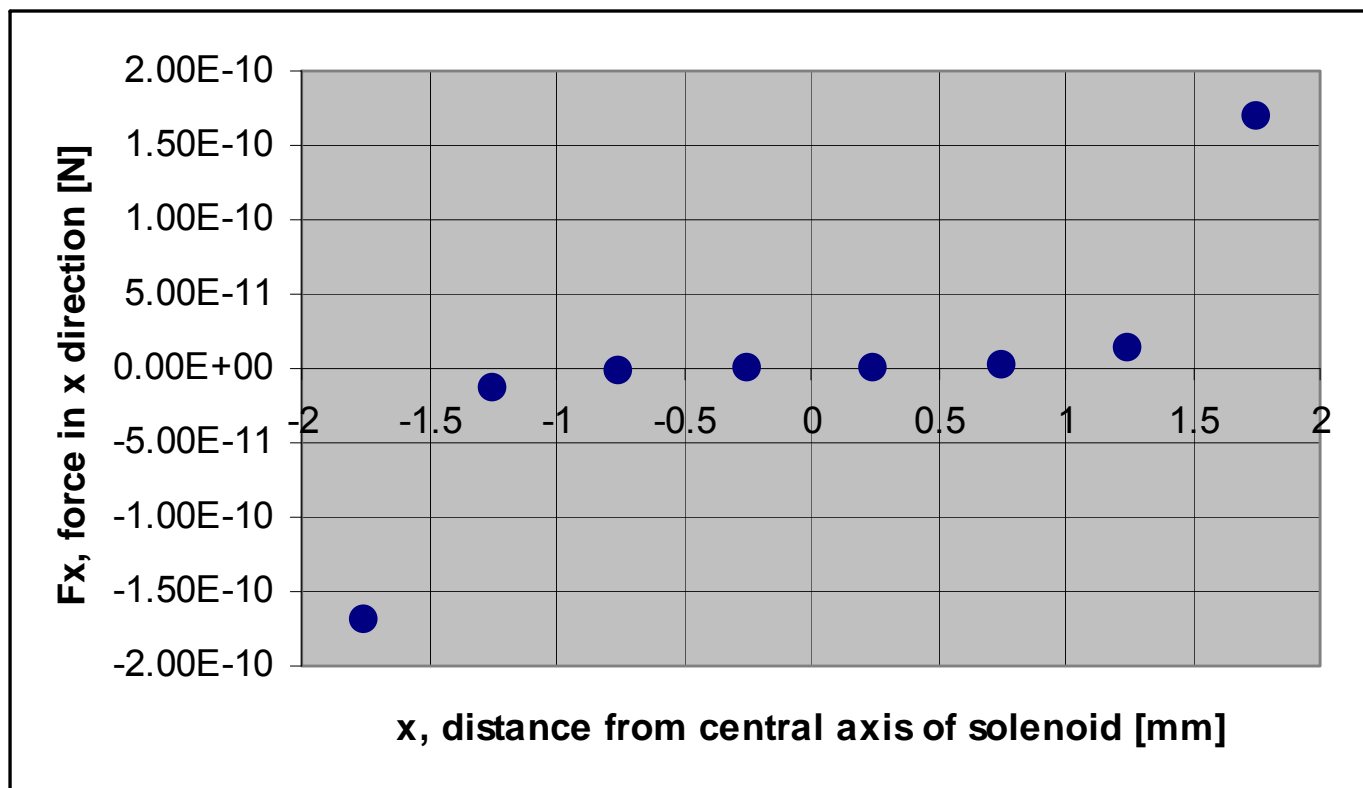

Force on 8 adjacent coils, shows a maximum outward force of 1.7×10^{-10} N on the outer coils. On a 0.25mm radius coil of approximate mass 1.2×10^{-6} kg the outward acceleration is 0.14×10^{-3} m/s². In the 0.05s it takes the coil to traverse the solenoid then based on this acceleration the outward spread of the particle is calculated to be only 6 μ m.



Conclusions on magnetic field interactions

- Axial force on a conductor moving through the centre of a solenoid is proportional to the conductor size to the power 5.
- Axial deceleration of a conductor moving through the centre of a solenoid is proportional to the conductor size squared.
- Repulsive forces exist between adjacent coils (particles) that each have their own current loop.
- The radial outward force on a stack of adjacent coils passing through the middle of a solenoid is greatest on the exterior coils.
- For the case of a tungsten particle jet of radius 10mm and particle radius 0.25mm passing through a 12.5T solenoid at 20m/s this analysis indicates that -
the axial deceleration of the particles is negligible
the radial acceleration of the particles is negligible

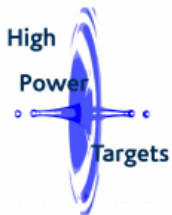

Powder jet target plant - outline layout

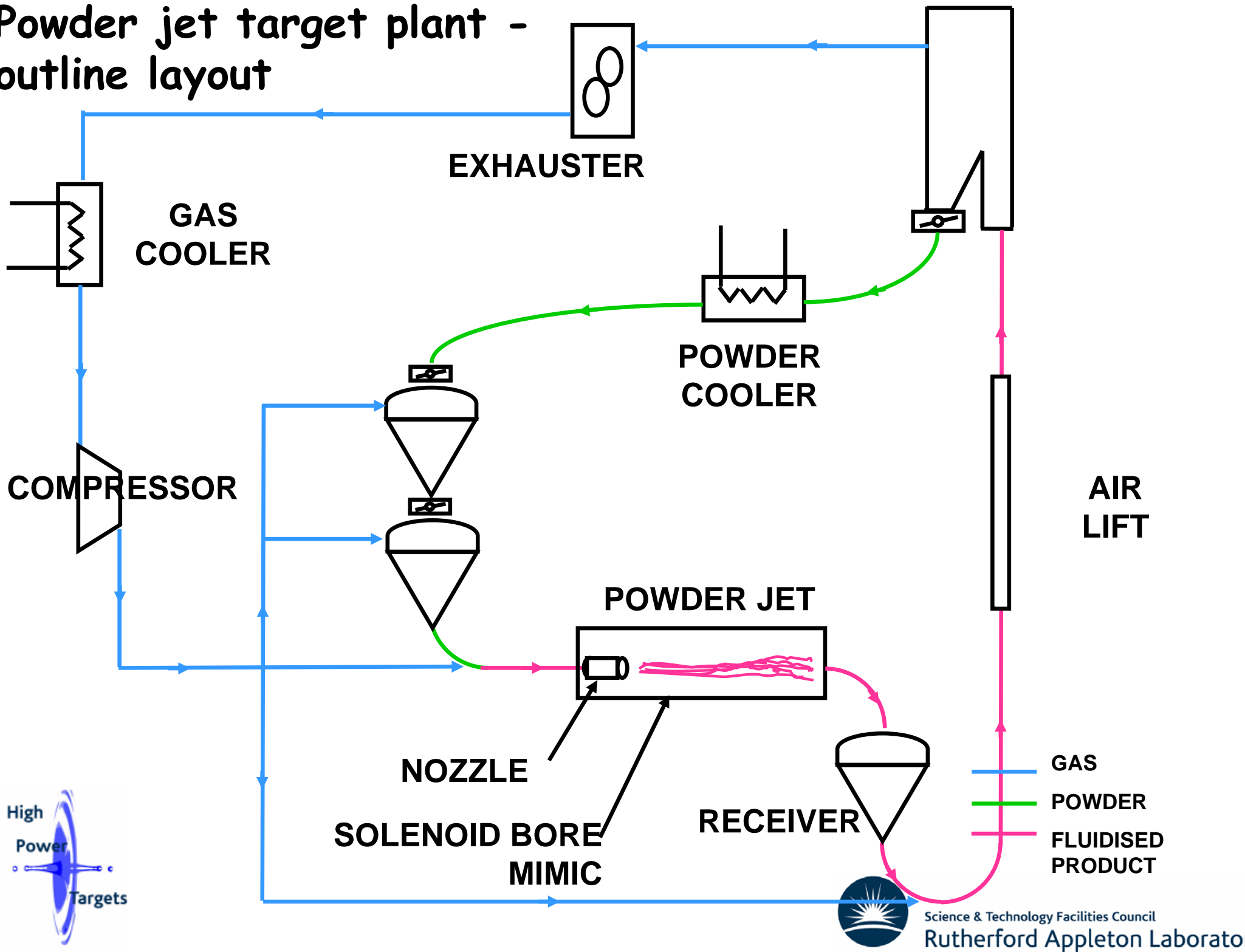

Feasibility test: 30th August 2007

- Tungsten powder < 250 μm particle size
- Discharge pipe length = 1 m
- Pipe diameter = 2 cm
- 3.9 bar (net) pneumatic driving pressure
- Vacuum lift to recirculate powder
- Co-axial return air flow at entry of jet into mimic of solenoid bore



Feasibility test results:

5000 fps
frame : 1100

1/5000 sec
+00:00:00.219800sec

1024 x 512

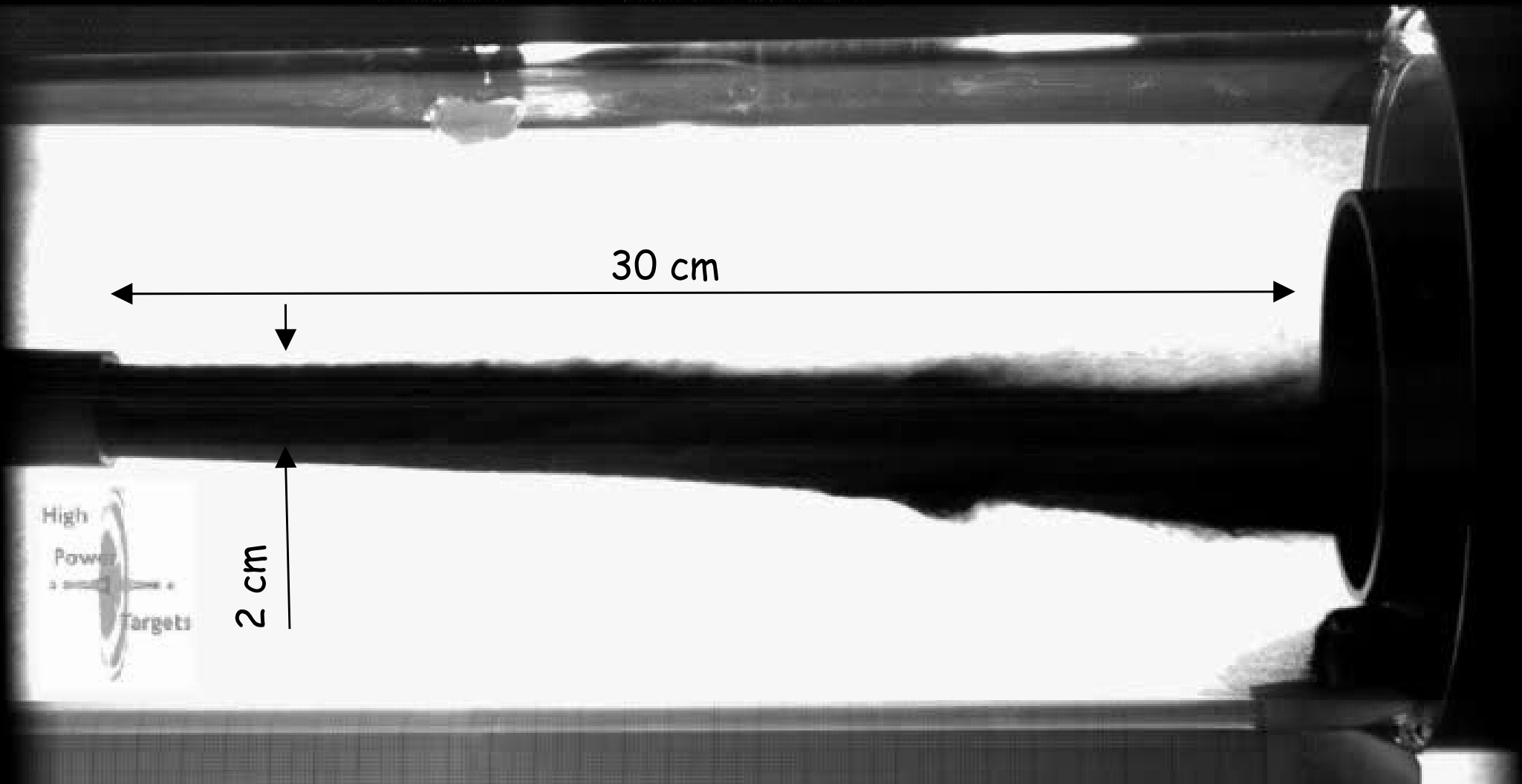

(Thanks to EPSRC Instrument Loan Pool for use of a high speed video camera)

Chris Densham
Oxford 1-2 May 2008

HPT



Science & Technology Facilities Council
Rutherford Appleton Laboratory

Tungsten powder jet - feasibility test results



Initial bulk density
= 8660 kg/m^3
= 45 % W (by volume)

Jet bulk density
(approx. results):
Jet velocity = 7-15 m/s
(100 kg in 8 seconds)
~ 5000 kg/m^3
~ 28 % W by vol.
(~ 2.5 x graphite density)

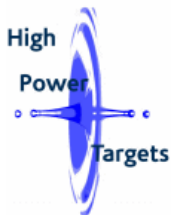

The rig during construction in March 2008



Powder jets: next stages

- Carry out long term erosion test
- Improve diagnostics of jet quality
- Improve bulk density of jet (28% -> 45% by volume?)
 - By changing discharge pipe length?
 - By incorporating porous (sintered) material into discharge pipe?
 - By use of a nozzle?
- Demonstrate shock waves are not a problem
 - Possibility to use test facility planned at ISOLDE for shock wave experiment on a powder sample - as for the mercury thimble experiment (Jacques Lettry)
- Demonstrate magnetic fields/eddy currents are not a problem
 - Use of high field solenoid (post MERIT - collaboration with CERN + Harold Kirk?)

